

butech



**professional
book**

PORCELANOSA Grupo



PORCELANOSA Grupo

Trusted professional solutions

BUTECH is part of Grupo PORCELANOSA, a world leader in the design and production of superior quality ceramics. Following on from adhesives and sealing materials for ceramics, BUTECH has evolved to more complex installation systems such as façades and technical flooring.

BUTECH's main aim is to provide PORCELANOSA customers with materials and installation systems which enable successful installation of any type of ceramic flooring or cladding.

BUTECH knows what every kind of ceramics needs and offers technical as well as decorative solutions which allow its installation with total success guarantee.

Spirit of innovation

BUTECH has invested in the latest technology to develop technical solutions which facilitate the commissioning and delivery of even better designs using PORCELANOSA ceramics.

Over the last few years, BUTECH has introduced innovative installation materials, decorative profiles, shower tray and levelling systems which have become an industry standard. Moreover, BUTECH is a leading company in innovation and development of façade systems for the various cladding materials from Grupo PORCELANOSA: STON-KER, PAR-KER, SOLID-KER, XLIGHT, XTONE, NATURAL STONE AND KRION.

butech



Corporate Social Responsibility

At butech, we only consume electricity from guaranteed renewable sources. We generate 30% of the energy we use at Porcelanosa Group ourselves. Over 90% of the lighting in our premises is high-performance, low-consumption led lighting. Half of our indoor surface area receives natural light, which reduces electricity consumption.

More than 95% of the waste generated by Porcelanosa is reused, recycled or repurposed. We have reduced water consumption in our tile manufacturing processes by 20%. We minimize water and gas use by dry pressing our ceramics. 100% of the wastewater is purified and reused, producing 0 litres of discharge. We calculate and reduce our carbon footprint every year, ensuring our commitment as a circular economy.

Environmental commitment

The environmental commitment butech has shown toward its immediate surroundings and the environment as a whole has characterized the company since its origins is clearly reflected by environmental ideas and initiatives, including substantial yearly investment into systems for recycling water, waste reuse, environmental protection and energy saving and it is a ISO 14001 certified environmental management system.



Index

8
PROFILES AND SKIRTINGS

110
ADHESIVES

134
**GROUTING MATERIAL AND
ELASTIC JOINT SEALANTS**

152
**SUBSTRATE PREPARATION
PRODUCTS**

164
**SHOWER TRAYS AND
WATERPROOFING**

198
SYSTEMS



PROFILES AND SKIRTINGS

LED PROFILES

pro-light 7.5, **12** | pro-light 11, **14** | pro-corner light, **16** | pro-telo light, **18**
pro-telo light slim, **18** | pro-mate 45 TOP light, **20** | pro-skirting LED, **22**
COB LED strip, **24** | LED transformer, **24**

DECORATIVE PROFILES

CRYSTAL COLLECTION, **28**

pro-part Li crystal SW galaxy, **28** | pro-part Li crystal rock SW silver, **28**
pro-part Li crystal sand SW gold, **30** | pro-part Li crystal sand SW silver, **30**
pro-part crystal SW gold, **32** | pro-part crystal SW silver, **32**

GOLD COLLECTION, **34**

pro-part Li gold, **34** | pro-part gold, **34**
pro-mate 5 gold, **34** | pro-part antique gold, **36**

TEXTURE COLLECTION, **38**

pro-part bone, **38** | pro-part coal, **40** | pro-part cast iron, **42**
pro-part cast copper, **44** | pro-part cement, **46** | pro-part sand, **48**

METAL COLLECTION, **50**

pro-part anthracite, **50** | pro-part old iron, **52** | pro-part old bronze, **54**
pro-part rose, **56** | pro-part rose line, **56** | pro-part moon, **58** | pro-part moon line, **58**
pro-part graphite matt, **60** | pro-part graphite matt line, **60** | pro-part graphite, **62**
pro-part line, **64** | pro-part line matt, **64**

CHROME COLLECTION, **66**

pro-part chrome, **66** | pro-mate 5 chrome, **66** | pro-mate 3 chrome, **66**
pro-part Li chrome, **67** | pro-mate 45 TOP chrome, **67** | pro-mate 45 chrome, **67**

PRO-TELO COLLECTION, **70**

pro-telo inox 8x40, **69** | pro-telo inox 8x25, **69**
pro-telo aluminium 8x10, **69** | pro-telo recto 8x10, **69**

CORNER PROFILES AND TRIMS FOR WALL TILES

pro-mate 2, **72** | pro-mate 3, **73** | pro-mate 5, **74** | pro-part Li, **75**
pro-part, **76** | pro-mate 45, **78** | pro-corner, **79** | 3 metres profiles, **80**

TECHNICAL PROFILES

pro-T, **84** | pro-level, **85** | pro-shower, **86** | pro-sanit, **87**
pro-dilata, **88** | structural joints, **90** | pro-step, **91**

SKIRTINGS

pro-skirting, **94** | pro-skirting customized, **96**
pro-skirting PAR-KER, **98** | pro-plint, **108**



LED PROFILES

LED PROFILES

Decorative profile. Luminescent range for ceramic coverings.

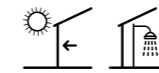

pro-light silver 7.5 mm

pro-light 7.5 mm

Anodized aluminium

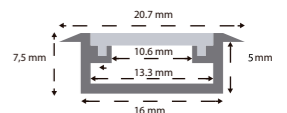

pro-light black
21x7.5x2500 mm

100243703
90.18 p/u



pro-light silver
21x7.5x2500 mm

100243677
90.18 p/u

Lighting system not included. Includes profile, diffuser, corner and clips.

Luminescent range for ceramic coverings.



pro-light silver 11 mm

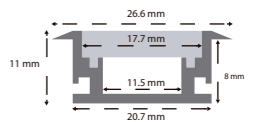

pro-light 11 mm

Anodized aluminium



pro-light silver 11mm
27x11x2500 mm

100202237
79.59 p/u

Lighting system not included. Includes profile, diffuser and corner.

LED PROFILES

Decorative profile. Luminescent range for ceramic coverings.



pro-corner light

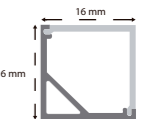

pro-corner light

Anodized aluminium



pro-corner light
16x16x2500 mm

100243678
90.18 p/u

Lighting system not included. Includes profile, diffuser, corner and clips.

Decorative profile. Luminescent range for ceramic coverings.

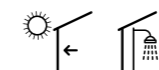

pro-telo light

pro-telo light

Anodized aluminium

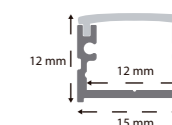

pro-telo light black
15x12x3000 mm

100281601
82.49 p/u



pro-telo light silver
15x12x3000 mm

100281600
73.77 p/u

pro-telo light slim

Anodized aluminium

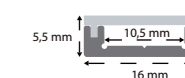

pro-telo light slim black
16x5.5x2500 mm

100328075
68.80 p/u



pro-telo light slim silver
16x5.5x2500 mm

100328096
54.90 p/u

Lighting system not included. Includes profile, diffuser, corner and clips.

LED PROFILES

Decorative profile. Luminescent range for ceramic coverings.

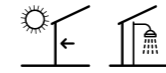

pro-mate 45 TOP light

pro-mate 45 TOP light

Anodized aluminium

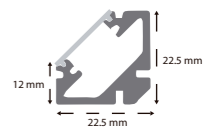

pro-mate 45 TOP light
22.5x22.5x2500 mm

100243649
103.89 p/u

Lighting system not included. Includes profile, diffuser, corner and clips.

Decorative profile. Luminescent range for ceramic coverings.

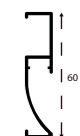

pro-skirting LED

Anodized aluminium



- pro-skirting LED black** 100200414
13x60x2500 mm **33.84** p/u
- pro-skirting LED corner black** 100213201
13x60x5 mm **12.38** p/u

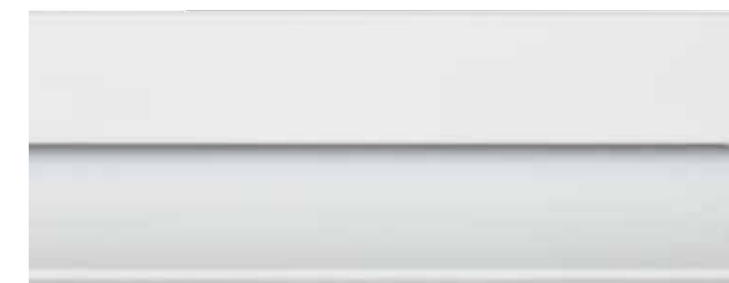

- pro-skirting LED white** 100200418
13x60x2500 mm **31.94** p/u
- pro-skirting LED corner white** 100213220
13x60x5 mm **12.38** p/u



- pro-skirting LED silver** 100200403
13x60x2500 mm **33.84** p/u
- pro-skirting LED corner silver** 100213154
13x60x5 mm **11.05** p/u

complements

- diffuser pro-skirting LED** 100232655
2500 mm **16.52** p/u
- fixing clips pro-skirting LED** 100193608
17x30 mm 50 ud **15.80** p/bag

Diffuser and lighting system not included.
Caps are supplied separately.

pro-skirting LED white

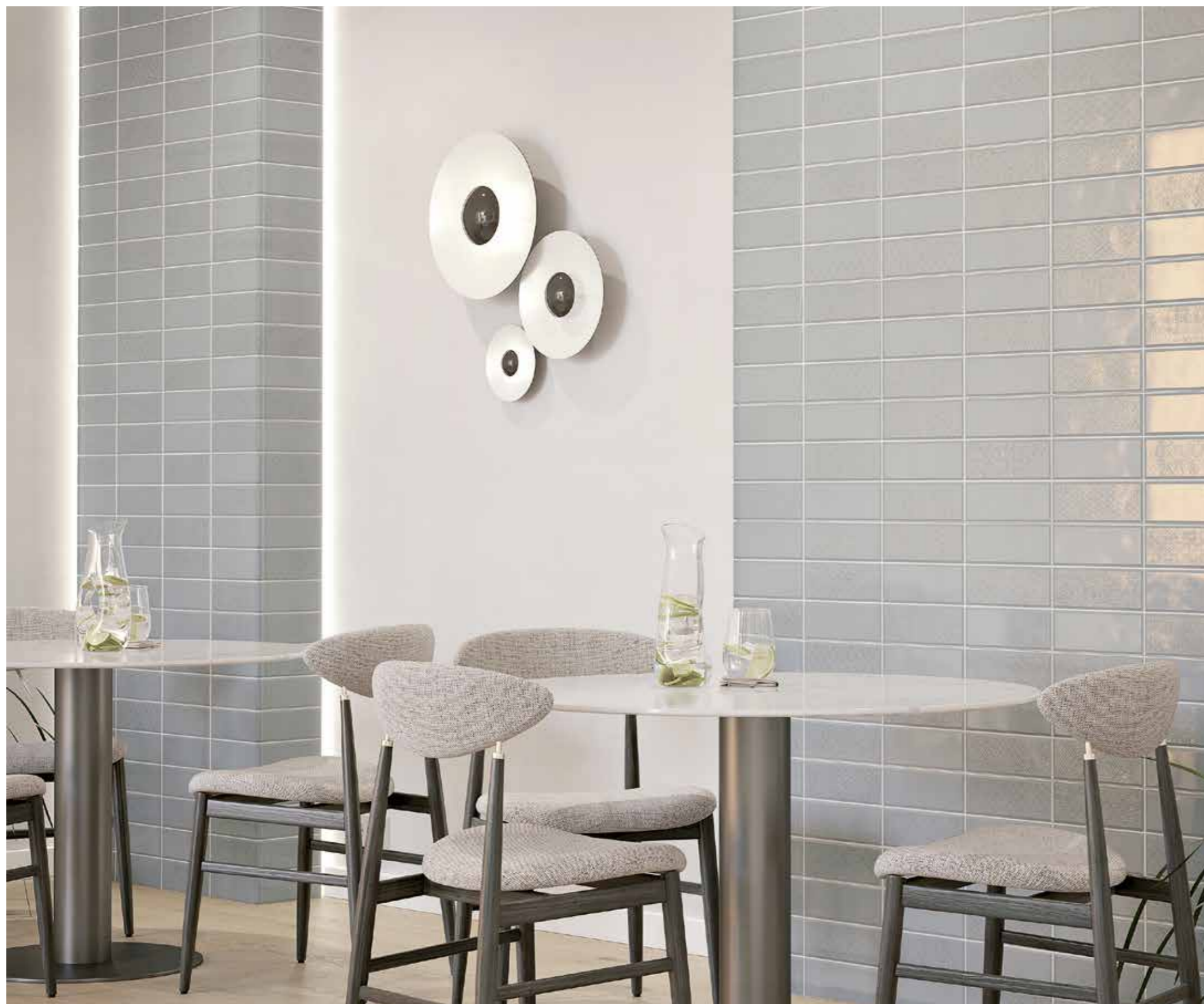

pro-light silver 11 mm

COB LED strip

Linear lighting system for profiles from the pro-light collection. Except for pro-skirting LED.

COB LED luminaires are packages of multiple LEDs that are joined together into a single lighting module. In practice, only one point of light is seen, but with a higher light output. That is, with the same power as an SMD, more lumens / watt are achieved.

COB LED strip IP20

| | |
|--|--------------------------------------|
| COB LED strip IP20 3000°K 2x10x2500 mm | 100298585 87.62 p/u |
| COB LED strip IP20 4000°K 2x10x2500 mm | 100298526 87.62 p/u |
| COB LED strip IP20 6500°K 2x10x2500 mm | 100298597 87.62 p/u |

| | | | |
|------------|--------|----------------|------------|
| Power | 15 W/m | Lumens 3.000°K | 1400 Lm/m* |
| Voltage | 24 V | Lumens 4.000°K | 1500 Lm/m* |
| N° chips/m | 480 | Lumens 6.500°K | 1530 Lm/m* |
| PCB | 10 mm | Light emission | 180° |

IP20: For use in dry environments. Interior flooring and coverings.

COB LED strip IP67

| | |
|--|---------------------------------------|
| COB LED strip IP67 3000°K 4,6x11,6x2500 mm | 100298620 112.99 p/u |
| COB LED strip IP67 4000°K 4,6x11,6x2500 mm | 100298587 112.99 p/u |
| COB LED strip IP67 6500°K 4,6x11,6x2500 mm | 100298621 112.99 p/u |

| | | | |
|------------|---------|----------------|------------|
| Power | 15 W/m | Lumens 3.000°K | 1205 Lm/m* |
| Voltage | 24 V | Lumens 4.000°K | 1216 Lm/m* |
| N° chips/m | 480 | Lumens 6.500°K | 1210 Lm/m* |
| PCB | 11,6 mm | Light emission | 180° |

IP67: For use in wet environments. Interior flooring and coverings and exterior coverings.

LED transformer

| | |
|---|--------------------------------------|
| Transf. pro-light 100W 24V 0-5 mts 190x52x39 mm | 100200310 99.43 p/u |
|---|--------------------------------------|

| | |
|-----------------------------|-------|
| Power | 100 W |
| Voltage | 24 V |
| Electric current | 4.2 A |
| Maximum length of led strip | 5 m |

* The light output (Lumens) of COB LED strips may vary slightly from one strip to another.



DECORATIVE PROFILES

CRYSTAL COLLECTION

High-end decorative profile for ceramic wall tiling, made with Swarovski crystals. Replaces the traditional decorative ceramic listellos by new design metallic lines.

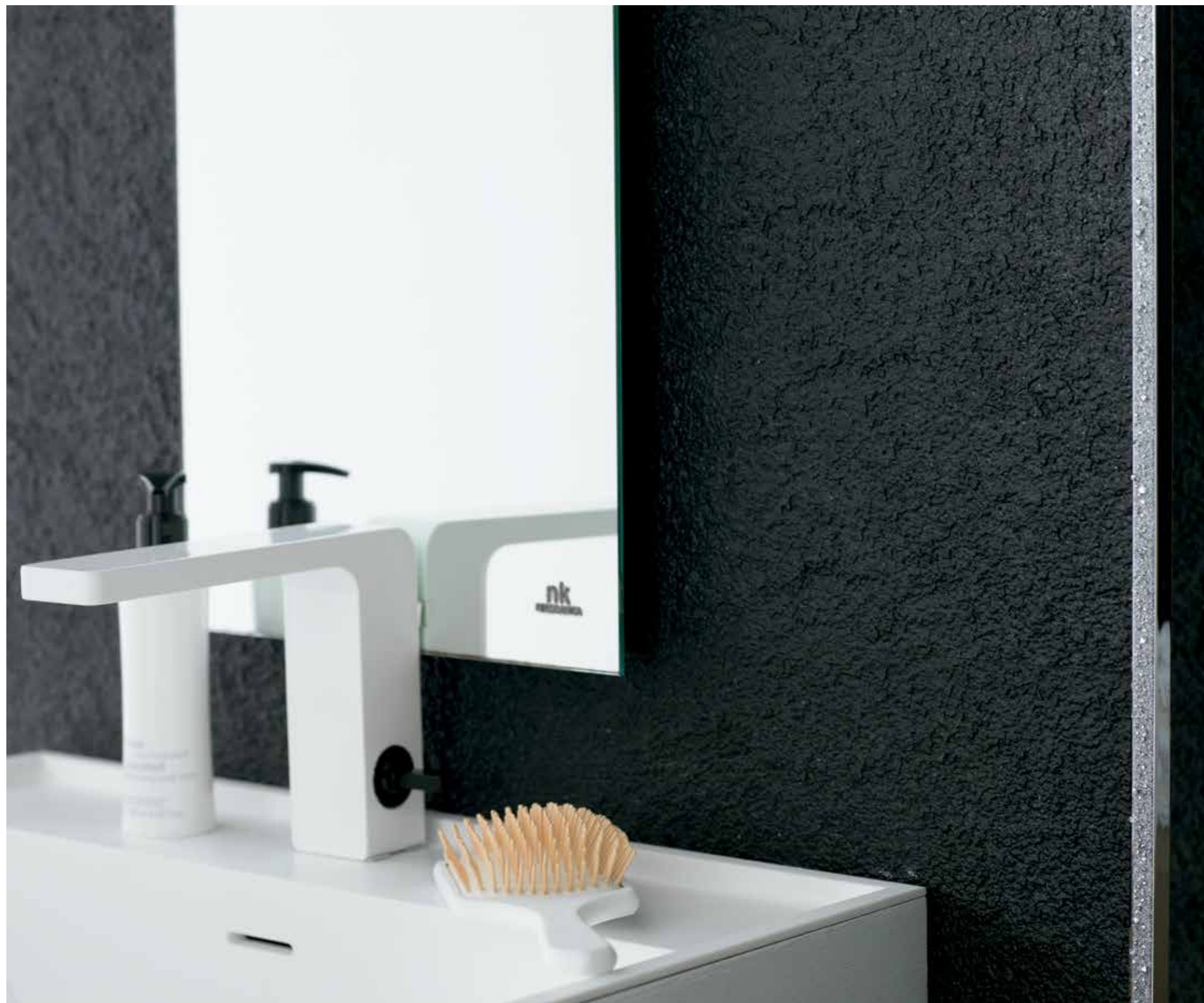

pro-part Li crystal SW galaxy

Not recommended for walls in direct contact with water.

pro-part Li crystal SW galaxy

Chromed brass profile. Made with Swarovski Elements



pro-part Li crystal galaxy 11 mm
12x11x2500 mm

100171653
497.27 p/u

pro-part Li crystal rock SW silver

Chromed brass profile. Made with Swarovski Elements



pro-part Li Crystal rock SW silver 11mm
12x11x2500 mm

100130429
592.20 p/u

CRYSTAL COLLECTION

High-end decorative profile for ceramic wall tiling, made with Swarovski crystals.
Replaces the traditional decorative ceramic listellos by new design metallic lines.



pro-part Li Crystal sand SW silver

Not recommended for walls in direct contact with water.

pro-part Li Crystal sand SW Gold

24 k Gold plated. Made with Swarovski Elements



pro-part Li crystal sand SW Gold 11mm
12x11x2500 mm

100130430
484.04 p/u

pro-part Li Crystal sand SW Silver

Chromed brass profile. Made with Swarovski Elements



pro-part Li crystal sand SW silver 11mm
12x11x2500 mm

100130431
412.64 p/u

CRYSTAL COLLECTION

High-end decorative profile for ceramic wall tiling, made with Swarovski crystals.
Replaces the traditional decorative ceramic listellos by new design metallic lines.



pro-part crystal SW silver

Not recommended for walls in direct contact with water.

pro-part crystal SW gold

24 k Gold plated. Made with Swarovski Elements

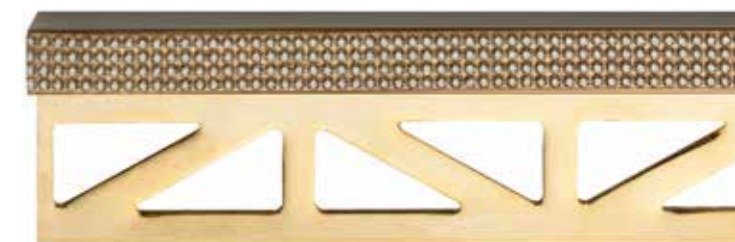

pro-part crystal SW gold 11mm
8x11x2500 mm

100155354
849.69 p/u

pro-part crystal SW silver

Chromed brass profile. Made with Swarovski Elements



pro-part crystal SW silver 11mm
8x11x2500 mm

100155356
699.28 p/u

GOLD COLLECTION

High-end decorative profile for wall tiles, 24K Gold plated.
It substitutes the traditional ceramic frieze by a metallic line with an exclusive design.

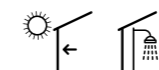

pro-part gold

pro-part Li gold

24 carat Gold plated profile. 12 and 13,5 mm decorative trim.



| | |
|---|--------------------------------|
| pro-part Li gold 11mm 12x11x2500 mm | 100100726 150.68 p/u |
| pro-part Li gold 12,5mm 13,5x12,5x2500 mm | 100100762 156.59 p/u |

pro-part gold

24 carat Gold plated profile. 8 mm decorative trim.



| | |
|---|--------------------------------|
| pro-part gold 7mm 8x7x2500 mm | 100246452 147.43 p/u |
| pro-part gold 9mm 8x9x2500 mm | 100331779 132.20 p/u |
| pro-part gold 11mm 8x11x2500 mm | 100100724 134.21 p/u |
| pro-part gold 12.5mm 8x12,5x2500 mm | 100100725 144.28 p/u |

pro-mate 5 gold

24 carat Gold plated profile. 5 mm decorative trim.



| | |
|---|--------------------------------|
| pro-mate 5 gold 11mm 5x11x2500 m | 100100721 125.25 p/u |
| pro-mate 5 gold 12.5mm 5x12,5x2500 mm | 100100722 126.87 p/u |

GOLD COLLECTION

High-end decorative profile for wall tiles.
It substitutes the traditional ceramic frieze by a metallic line with an exclusive design.

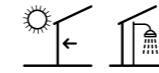

pro-part gold antique

pro-part antique gold

Brushed gold finishes profile. 8 mm decorative trim.



pro-part antique gold 11 mm
8x11x2500 mm

100314848
105.34 p/u

Matte metallic finish decorative profiles for ceramic wall tiles. It substitutes the traditional ceramic frieze.



pro-part bone

pro-part bone

Brass profile with matte metallic covering. 8 mm decorative trim.



| | |
|---|-------------------------------|
| pro-part bone 7mm 8x7x2500 mm | 100278708 87.75 p/u |
| pro-part bone 11mm 8x11x2500 mm | 100269007 90.75 p/u |
| pro-part bone 12,5mm 8x12,5x2500 mm | 100278730 92.37 p/u |

Matte metallic finish decorative profiles for ceramic wall tiles. It substitutes the traditional ceramic frieze.

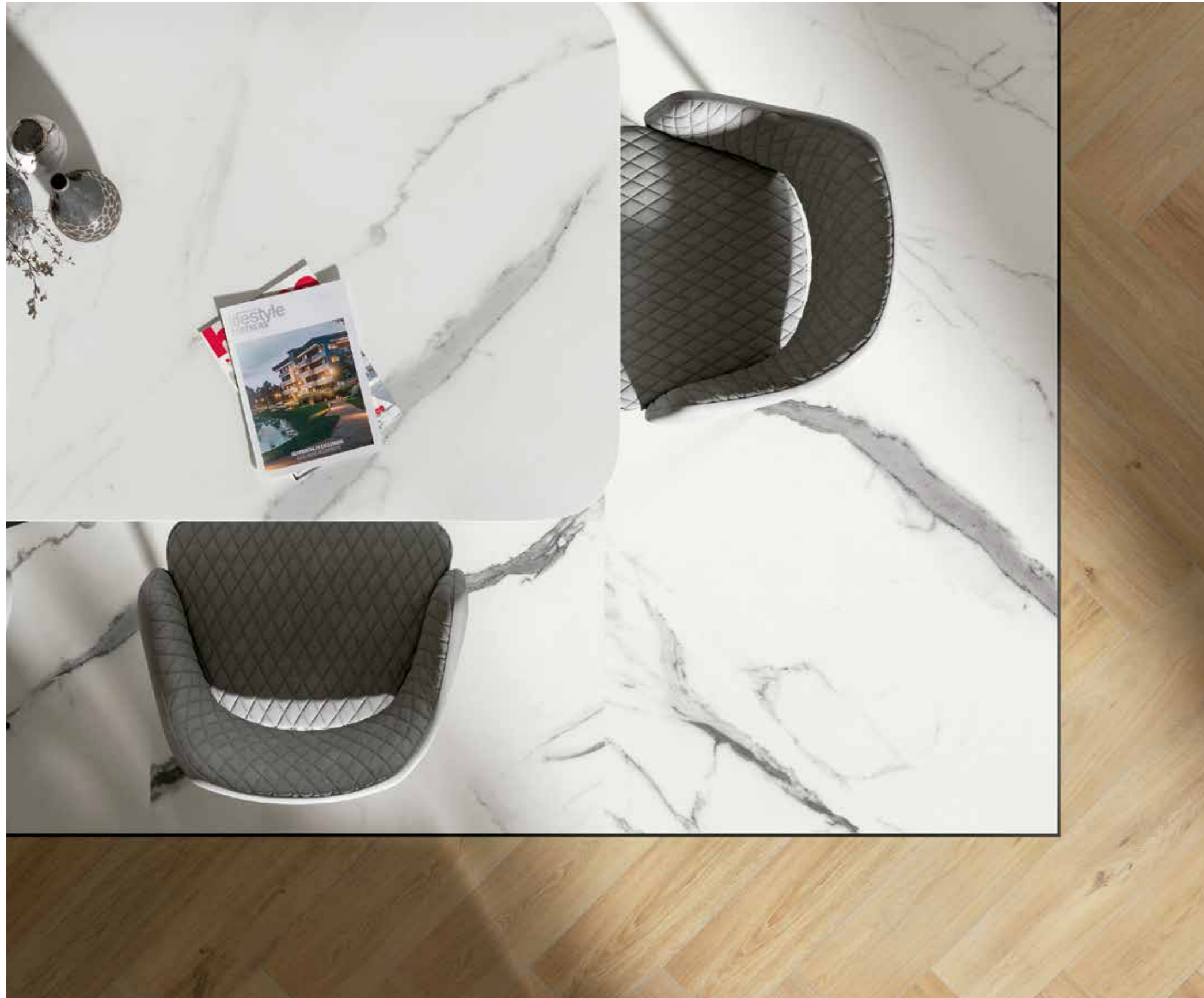

pro-part coal

Brass profile with matte metallic covering. 8 mm decorative trim.



| | |
|---|-------------------------------|
| pro-part coal 7mm 8x7x2500 mm | 100278697 87.75 p/u |
| pro-part coal 9mm 8x9x2500 mm | 100326478 89.20 p/u |
| pro-part coal 11mm 8x11x2500 mm | 100269081 90.75 p/u |
| pro-part coal 12,5mm 8x12,5x2500 mm | 100278751 92.37 p/u |

Matte metallic finish decorative profiles for ceramic wall tiles. It substitutes the traditional ceramic frieze.



pro-part cast iron

pro-part cast iron

Brass profile with matte metallic covering. 8 mm decorative trim.



| | |
|--|-------------------------------|
| pro-part cast iron 7mm 8x7x2500 mm | 100285068 72.52 p/u |
| pro-part cast iron 9mm 8x9x2500 mm | 100326516 89.20 p/u |
| pro-part cast iron 11mm 8x11x2500 mm | 100222994 90.75 p/u |
| pro-part cast iron 12,5mm 8x12,5x2500 mm | 100278717 92.37 p/u |

Matte metallic finish decorative profiles for ceramic wall tiles. It substitutes the traditional ceramic frieze.



pro-part cast copper

pro-part cast copper

Brass profile with matte metallic covering. 8 mm decorative trim.



| | |
|--|-------------------------------|
| pro-part cast copper 9mm 8x9x2500 mm | 100326509 89.20 p/u |
| pro-part cast copper 11mm 8x11x2500 mm | 100223015 90.75 p/u |

Matte metallic finish decorative profiles for ceramic wall tiles. It substitutes the traditional ceramic frieze.



pro-part cement

pro-part cement

Brass profile with matte metallic covering. 8 mm decorative trim.



pro-part cement 9mm
8x9x2500 mm

100326530
89.20 p/u

pro-part cement 11mm
8x11x2500 mm

100226161
90.75 p/u

Matte metallic finish decorative profiles for ceramic wall tiles. It substitutes the traditional ceramic frieze.



pro-part sand

pro-part sand

Brass profile with matte metallic covering. 8 mm decorative trim.



pro-part sand 9mm
8x9x2500 mm

100326531
89.20 p/u

pro-part sand 11mm
8x11x2500 mm

100226152
90.75 p/u

Metallic finish decorative profiles for ceramic wall tiles. It substitutes the traditional ceramic frieze.

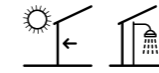

pro-part anthracite

pro-part anthracite

Brass profile with metallic covering. 8 mm decorative trim.



pro-part anthracite 11mm
8x11x2500mm

100315557
83.26 p/u

METAL COLLECTION

Metallic finish decorative profiles for ceramic wall tiles. It substitutes the traditional ceramic frieze.

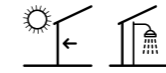

pro-part old iron

pro-part old iron

Brass profile with metallic covering. 8 mm decorative trim.



pro-part old iron 11mm
8x11x2500mm

100189093
110.24 p/u

METAL COLLECTION

Metallic finish decorative profiles for ceramic wall tiles. It substitutes the traditional ceramic frieze.

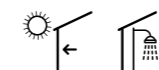

pro-part old bronze

pro-part old bronze

Brass profile with metallic covering. 8 mm decorative trim.



| | |
|--|--------------------------------|
| pro-part old bronze 7mm 8x7x2500mm | 100278752 116.72 p/u |
| pro-part old bronze 11mm 8x11x2500mm | 100189092 112.41 p/u |
| pro-part old bronze 12,5mm 8x12,5x2500mm | 100243964 117.60 p/u |

Matte metallic finish decorative profiles for ceramic wall tiles. It substitutes the traditional ceramic frieze.

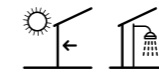

pro-part rose line

pro-part rose

Brass profile with matte metallic covering. 8 mm decorative trim.



| | | |
|-----------------------------|----------------|--------------------------------|
| Shade 1 | | |
| pro-part rose 7mm | 8x7x2500 mm | 100232244 148.35 p/u |
| pro-part rose 9mm | 8x9x2500 mm | 100332742 149.20 p/u |
| pro-part rose 11mm | 8x11x2500 mm | 100231592 137.89 p/u |
| pro-part rose 12,5mm | 8x12,5x2500 mm | 100278753 153.58 p/u |
| Shade 2 | | |
| pro-part rose 7mm | 8x7x2500 mm | 100297853 148.35 p/u |
| pro-part rose 11mm | 8x11x2500 mm | 100297848 137.89 p/u |
| pro-part rose 12,5mm | 8x12,5x2500 mm | 100297612 153.58 p/u |

pro-part rose line

Brass profile with matte metallic covering. 8 mm decorative trim.



| | | |
|----------------------------------|----------------|--------------------------------|
| Shade 1 | | |
| pro-part rose line 7mm | 8x7x2500 mm | 100232236 150.33 p/u |
| pro-part rose line 9mm | 8x9x2500 mm | 100332761 151.20 p/u |
| pro-part rose line 11mm | 8x11x2500 mm | 100231584 140.15 p/u |
| pro-part rose line 12,5mm | 8x12,5x2500 mm | 100278736 152.53 p/u |
| Shade 2 | | |
| pro-part rose line 7mm | 8x7x2500 mm | 100297828 150.33 p/u |
| pro-part rose line 11mm | 8x11x2500 mm | 100297854 140.15 p/u |
| pro-part rose line 12,5mm | 8x12,5x2500 mm | 100297585 152.53 p/u |

Metallic finish decorative profiles for ceramic wall tiles. It substitutes the traditional ceramic frieze.

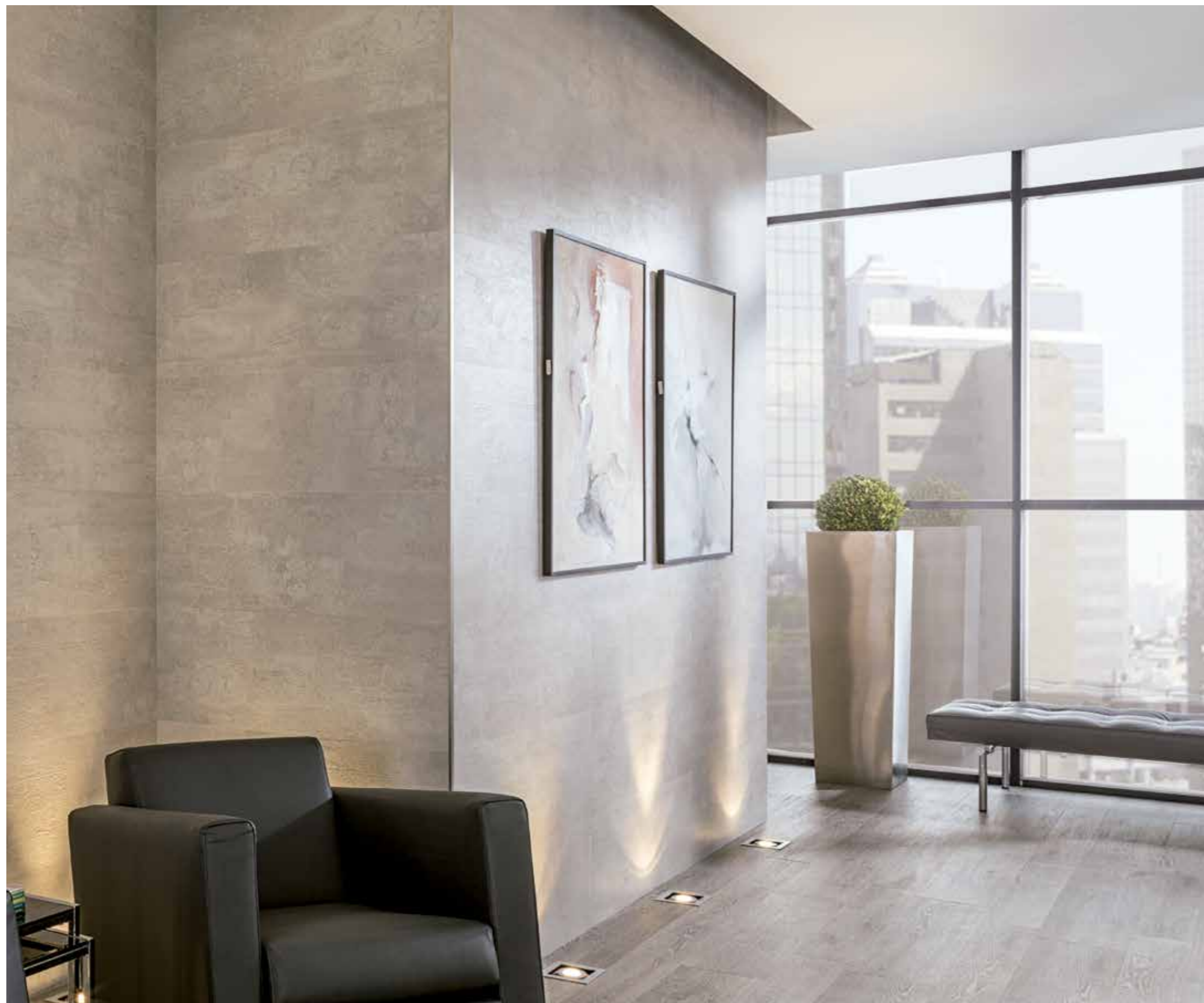
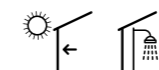

pro-part moon line

pro-part moon

Brass profile with metallic covering. 8 mm decorative trim.



| | | |
|-----------------------------|---------------|--------------------------------|
| Shade 1 | | |
| pro-part moon 7mm | 8x7x2500m | 100177056 101.26 p/u |
| pro-part moon 9mm | 8x9x2500m | 100332424 106.66 p/u |
| pro-part moon 11m | 8x11x2500mm | 100120369 108.91 p/u |
| pro-part moon 12,5mm | 8x12,5x2500mm | 100177071 107.86 p/u |

| | | |
|-----------------------------|---------------|--------------------------------|
| Shade 2 | | |
| pro-part moon 7mm | 8x7x2500m | 100297628 101.26 p/u |
| pro-part moon 11m | 8x11x2500mm | 100297599 108.91 p/u |
| pro-part moon 12,5mm | 8x12,5x2500mm | 100297691 107.86 p/u |

pro-part moon line

Brass profile with metallic covering. 8 mm decorative trim.



| | | |
|----------------------------------|---------------|--------------------------------|
| Shade 1 | | |
| pro-part moon line 7mm | 8x7x2500mm | 100177063 106.74 p/u |
| pro-part moon line 9mm | 8x9x2500mm | 100332740 107.14 p/u |
| pro-part moon line 11mm | 8x11x2500mm | 100158267 108.31 p/u |
| pro-part moon line 12,5mm | 8x12,5x2500mm | 100177080 106.07 p/u |

| | | |
|----------------------------------|---------------|--------------------------------|
| Shade 2 | | |
| pro-part moon line 7mm | 8x7x2500mm | 100297638 106.74 p/u |
| pro-part moon line 11mm | 8x11x2500mm | 100297641 108.31 p/u |
| pro-part moon line 12,5mm | 8x12,5x2500mm | 100297597 106.07 p/u |

Metallic finish decorative profiles for ceramic wall tiles. It substitutes the traditional ceramic frieze.

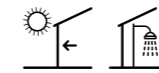

pro-part graphite matt line

pro-part graphite matt

Brass profile with metallic covering. 8 mm decorative trim.



Shade 1

| | |
|--|--------------------------------|
| pro-part graphite matt 7mm 8x7x2500 mm | 100177037 115.74 p/u |
| pro-part graphite matt 9mm 8x9x2500 mm | 100332398 116.20 p/u |
| pro-part graphite matt 11mm 8x11x2500 mm | 100158266 114.84 p/u |
| pro-part graphite matt 12,5mm 8x12,5x2500 mm | 100177053 116.86 p/u |

Shade 2

| | |
|--|--------------------------------|
| pro-part graphite matt 7mm 8x7x2500 mm | 100297570 115.74 p/u |
| pro-part graphite matt 11mm 8x11x2500 mm | 100297543 114.84 p/u |
| pro-part graphite matt 12,5mm 8x12,5x2500 mm | 100297607 116.86 p/u |

pro-part graphite matt line

Brass profile with metallic covering. 8 mm decorative trim.



Shade 1

| | |
|---|--------------------------------|
| pro-part graphite matt line 7mm 8x7x2500 mm | 100177055 115.74 p/u |
| pro-part graphite matt line 9mm 8x9x2500 mm | 100332417 117.20 p/u |
| pro-part graphite matt line 11mm 8x11x2500 mm | 100158265 115.61 p/u |
| pro-part graphite matt line 12,5mm 8x12,5x2500 mm | 100177036 119.67 p/u |

Shade 2

| | |
|---|--------------------------------|
| pro-part graphite matt line 7mm 8x7x2500 mm | 100297545 115.74 p/u |
| pro-part graphite matt line 11mm 8x11x2500 mm | 100297539 115.61 p/u |
| pro-part graphite matt line 12,5mm 8x12,5x2500 mm | 100297684 119.67 p/u |

Metallic finish decorative profiles for ceramic wall tiles. It substitutes the traditional ceramic frieze.

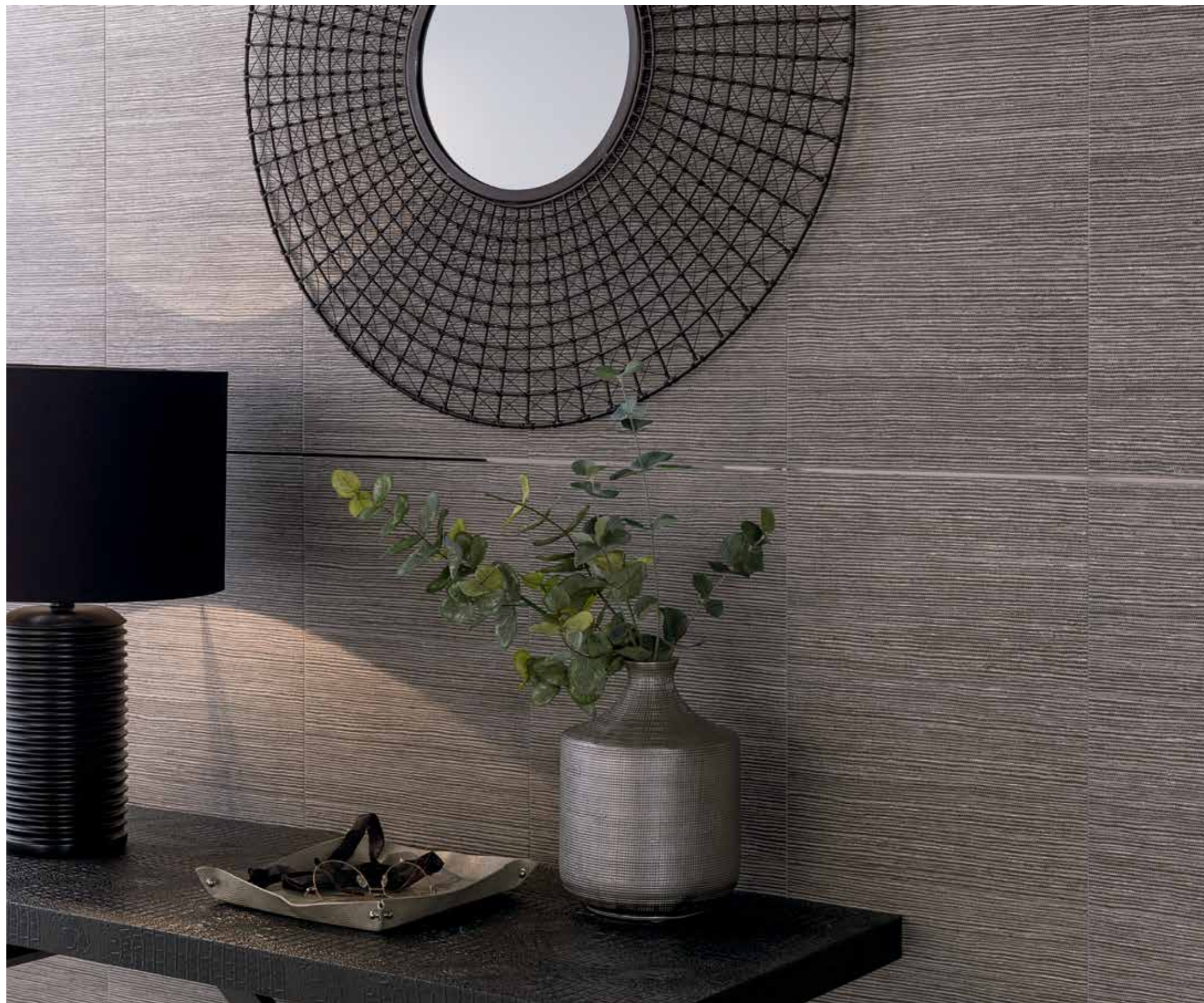
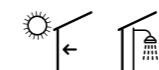

pro-part graphite

Brass profile with metallic covering. 8 mm decorative trim.



Shade 1

- pro-part graphite 7mm** 100177049
8x7x2500 mm **115.74** p/u
- pro-part graphite 9mm** 100332386
8x9x2500 mm **116.20** p/u
- pro-part graphite 11mm** 100120366
8x11x2500 mm **114.84** p/u
- pro-part graphite 12,5mm** 100177035
8x12,5x2500 mm **116.86** p/u

Shade 2

- pro-part graphite 7mm** 100297518
8x7x2500 mm **115.74** p/u
- pro-part graphite 11mm** 100297555
8x11x2500 mm **114.84** p/u
- pro-part graphite 12,5mm** 100297528
8x12,5x2500 mm **116.86** p/u

pro-part graphite

Metallic finish decorative profiles for ceramic wall tiles. It substitutes the traditional ceramic frieze.



pro-part line

pro-part line

Brass profile with metallic covering. 8 mm decorative trim.



| | |
|---|--------------------------------|
| pro-part line 7mm 8x7x2500 mm | 100177061 96.60 p/u |
| pro-part line 11mm 8x11x2500 mm | 100120367 102.98 p/u |
| pro-part line 12,5mm 8x12,5x2500 mm | 100177058 106.07 p/u |

pro-part line matt

Brass profile with metallic covering. 8 mm decorative trim.



| | |
|--|--------------------------------|
| pro-part line matt 7mm 8x7x2500 mm | 100177062 96.60 p/u |
| pro-part line matt 11mm 8x11x2500 mm | 100157798 102.98 p/u |
| pro-part line matt 12,5mm 8x12,5x2500 mm | 100177059 101.01 p/u |

CHROME COLLECTION

Chromed brass decorative profile for wall tiles. It substitutes the traditional decorative ceramic frieze.
Typical LIFESTYLE by PROCELANOSA profile.

Suitable for trimming corners and transitions between ceramic tiles.

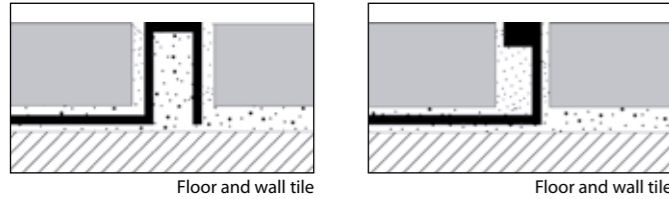

pro-part



| Chromed brass | | | Chromed brass corner | | |
|---------------|-----------|-------------------|----------------------|--------|------------------|
| SAP | h (mm) | P/EU | SAP | h (mm) | P/EU |
| 100005368 | 7 | 87.54 p/u | 100005373 | 7 | 31.82 p/u |
| 100177061 | Line | 96.60 p/u | 100005374 | 9 | 31.82 p/u |
| 100177062 | Line matt | 96.60 p/u | 100091065 | 10 | 30.95 p/u |
| 100005369 | 9 | 90.98 p/u | 100005375 | 11 | 31.82 p/u |
| 100088905 | 10 | 92.42 p/u | 100005376 | 12,5 | 31.82 p/u |
| 100005370 | 11 | 94.44 p/u | | | |
| 100120367 | Line | 102.98 p/u | | | |
| 100157798 | Line matt | 102.98 p/u | | | |
| 100005371 | 12,5 | 97.45 p/u | | | |
| 100177058 | Line | 106.07 p/u | | | |
| 100177059 | Line matt | 101.01 p/u | | | |

pro-mate 5

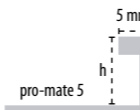

| Chromed brass | | |
|---------------|--------|------------------|
| SAP | h (mm) | P/EU |
| 100126779 | 7 | 79.54 p/u |
| 100004945 | 9 | 81.58 p/u |
| 100004946 | 11 | 84.56 p/u |
| 100004955 | 12,5 | 87.54 p/u |

pro-mate 3

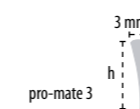

| Chromed brass | | |
|---------------|--------|------------------|
| SAP | h (mm) | P/EU |
| 100126772 | 6 | 70.98 p/u |
| 100004951 | 8 | 82.08 p/u |
| 100004952 | 9 | 71.83 p/u |
| 100004953 | 10 | 72.70 p/u |
| 100004954 | 12,5 | 74.46 p/u |



pro-part Li

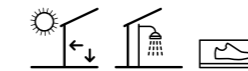

| Chromed brass | | | Chromed brass corner | | | |
|---------------|--------|--------|----------------------|-----------|--------|------------------|
| SAP | h (mm) | a (mm) | P/EU | SAP | h (mm) | P/EU |
| 100126780 | 4,5 | 5,5 | 108.43 p/u | 100098464 | 11 | 30.77 p/u |
| 100070170 | 11 | 12 | 104.66 p/u | 100085153 | 12,5 | 36.70 p/u |
| 100070171 | 12,5 | 13,5 | 110.23 p/u | | | |

pro-mate 45 TOP

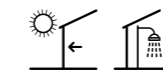

| Chromed brass | | |
|---------------|--------|------------------|
| SAP | h (mm) | P/EU |
| 100126778 | 6 | 79.93 p/u |
| 100099965 | 10 | 79.70 p/u |
| 100128801 | 12,5 | 99.04 p/u |

pro-mate 45

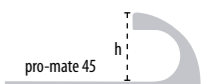
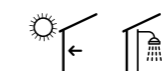

| Chromed brass | | |
|---------------|--------|------------------|
| SAP | h (mm) | P/EU |
| 100126776 | 6 | 81.99 p/u |
| 100099963 | 10 | 92.53 p/u |
| 100099964 | 12,5 | 98.90 p/u |

PRO-TELO COLLECTION

Metal decorative profile for ceramic wall tiles. Flangeless metallic line for tiles of any thickness.

Available in a wide variety of materials, finishes and dimensions, they represent an excellent solution for the design of contemporary style ceramic settings.

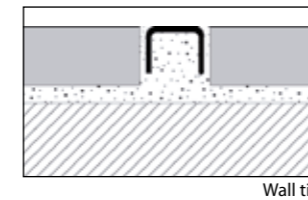
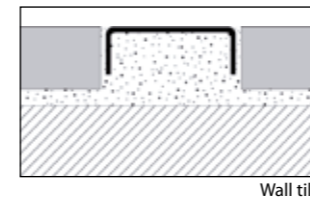

pro-telo stainless 8x40

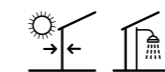

Stainless Steel 8x40

| SAP | Finish | h (mm) | P/EU |
|-----------|--------|--------|-----------|
| 100005299 | Gloss | 8 | 89.58 p/u |

pro-telo stainless 8x25

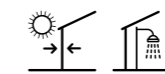

Stainless Steel 8x25

| SAP | Finish | h (mm) | P/EU |
|-----------|--------|--------|-----------|
| 100005293 | Gloss | 8 | 47.61 p/u |

pro-telo aluminium 8x10

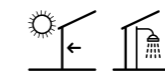

Aluminium 8x10 silver

| SAP | Finish | h (mm) | P/EU |
|-----------|----------|--------|-----------|
| 100005289 | Gloss | 8 | 33.41 p/u |
| 100005286 | Anodized | 8 | 21.25 p/u |

pro-telo recto 8x10

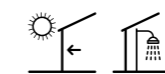

Aluminium 8x10

| SAP | Finish | h (mm) | P/EU |
|-----------|------------|--------|-----------|
| 100084015 | High gloss | 8 | 24.43 p/u |



pro-mate 2

Right angle, stainless steel profile for corners and wall and floor tile coverings.

Right angle, 2 mm thick stainless steel profiles for trimming the non-glazed edge of the tile. Suitable for separating tiles in walls as well as in floors.

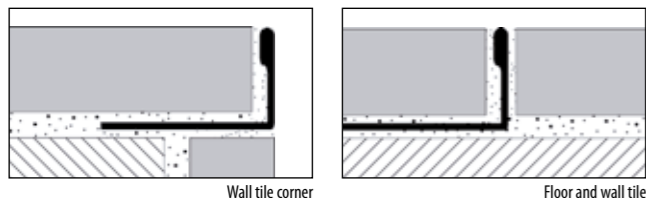

pro-mate 2

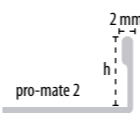

V2A Stainless steel

| SAP | h (mm) | P/EU |
|-----------|--------|-----------|
| 100126769 | 6 | 31.08 p/u |
| 100004957 | 10 | 30.85 p/u |
| 100004958 | 12,5 | 31.90 p/u |
| 100004959 | 15 | 46.44 p/u |
| 100004960 | 20 | 49.05 p/u |

V2A Gloss stainless steel

| SAP | h (mm) | P/EU |
|-----------|--------|-----------|
| 100004967 | 10 | 39.16 p/u |
| 100004968 | 12,5 | 47.47 p/u |
| 100004969 | 15 | 57.32 p/u |

V4A Stainless steel

| SAP | h (mm) | P/EU |
|-----------|--------|-----------|
| 100004964 | 10 | 34.02 p/u |
| 100004965 | 12,5 | 38.13 p/u |

pro-mate 3

Right angle profile for corners and wall and floor tile coverings. Decorative use as a metallic line.

Right angle, 3 mm thick profiles for trimming the non-glazed edge of the tile. Available in a wide variety of materials, they are also suitable for separating wall tiles.

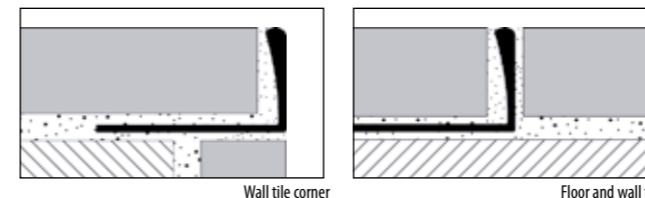

pro-mate 3

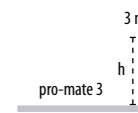

Chromed brass

| SAP | h (mm) | P/EU |
|-----------|--------|-----------|
| 100126772 | 6 | 70.98 p/u |
| 100004951 | 8 | 82.08 p/u |
| 100004952 | 9 | 71.83 p/u |
| 100004953 | 10 | 72.70 p/u |
| 100004954 | 12,5 | 74.46 p/u |

pro-mate 3

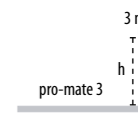

Anodized aluminium silver

| SAP | h (mm) | P/EU |
|-----------|--------|-----------|
| 100126770 | 6 | 24.95 p/u |
| 100004899 | 8 | 14.25 p/u |
| 100004900 | 9 | 15.43 p/u |
| 100004901 | 10 | 14.99 p/u |
| 100200608 | 11 | 14.34 p/u |
| 100004902 | 12,5 | 16.07 p/u |
| 100004903 | 15 | 18.29 p/u |

pro-mate 3

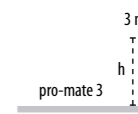
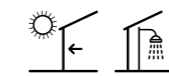

Lacquered aluminium

| SAP | h (mm) | P/EU |
|-----------|--------|-----------|
| 100126771 | 6 | 22.46 p/u |
| 100004911 | 10 | 21.97 p/u |
| 100004912 | 12,5 | 23.93 p/u |
| 100004915 | 10 | 21.97 p/u |
| 100004916 | 12,5 | 23.93 p/u |
| 100004919 | 10 | 21.97 p/u |
| 100004920 | 12,5 | 23.93 p/u |

High gloss aluminium

| SAP | h (mm) | P/EU |
|-----------|--------|-----------|
| 100289643 | 8 | 16.02 p/u |
| 100004925 | 10 | 30.91 p/u |
| 100004926 | 12,5 | 31.84 p/u |

PVC

| SAP | h (mm) | P/EU |
|-----------|--------|----------|
| 100004865 | 10 | 5.16 p/u |
| 100004873 | 12,5 | 5.56 p/u |
| 100004866 | 10 | 5.16 p/u |
| 100004867 | 10 | 5.16 p/u |
| 100004868 | 10 | 5.16 p/u |
| 100004869 | 10 | 5.16 p/u |

Black aluminium

| SAP | h (mm) | P/EU |
|-----------|--------|-----------|
| 100220142 | 8 | 32.60 p/u |
| 100171991 | 10 | 33.66 p/u |
| 100220132 | 12,5 | 33.61 p/u |

pro-mate 5

Right angle profile for corners and wall and floor tile coverings. Decorative use as a metallic line.

Right angle and 5 mm edge profiles for trimming the non-glazed edge of the tile. Suitable for transitions between floor coverings at the same level.

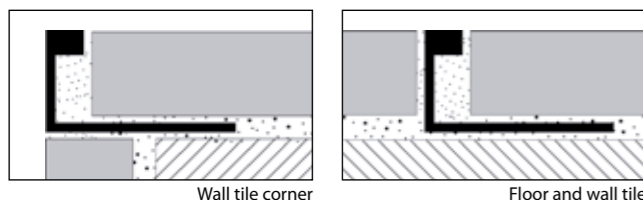

pro-mate 5

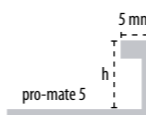

Chromed brass

| SAP | h (mm) | P/EU |
|-----------|--------|-----------|
| 100126779 | 7 | 79.54 p/u |
| 100004945 | 9 | 81.58 p/u |
| 100004946 | 11 | 84.56 p/u |
| 100004955 | 12,5 | 87.54 p/u |

pro-mate 5

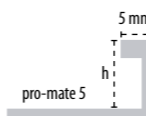

Anodized aluminium silver

| SAP | h (mm) | P/EU |
|-----------|--------|-----------|
| 100004927 | 11 | 23.97 p/u |

pro-mate 5

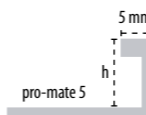
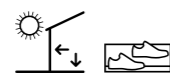

Gloss polished brass

| SAP | h (mm) | P/EU |
|-----------|--------|-----------|
| 100004944 | 11 | 61.53 p/u |

pro-part Li

Decorative profile for ceramic wall and floor tiles. Suitable for trimming corners and transitions between ceramic tiles.

Right angle, corner shaped profiles, with both sides of the same length. Specially recommended for rectified tiles corners and for tiles with relief decoration.

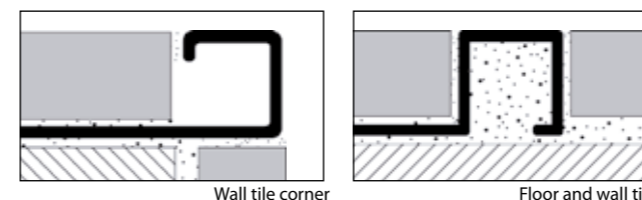

pro-part Li

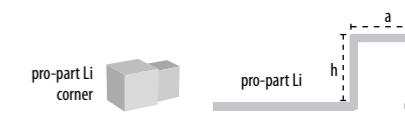
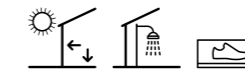

Chromed brass

| SAP | h (mm) | a (mm) | P/EU | SAP | h (mm) | P/EU |
|-----------|--------|--------|------------|-----------|--------|-----------|
| 100126780 | 4,5 | 5,5 | 108.43 p/u | 100098464 | 11 | 30.77 p/u |
| 100070170 | 11 | 12 | 104.66 p/u | 100085153 | 12,5 | 36.70 p/u |
| 100070171 | 12,5 | 13,5 | 110.23 p/u | | | |

pro-part Li

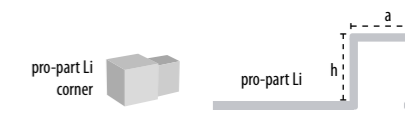
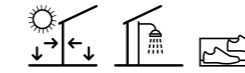

Anodized aluminium silver

| SAP | h (mm) | a (mm) | P/EU | SAP | h (mm) | P/EU |
|-----------|--------|--------|-----------|-----------|--------|-----------|
| 100128227 | 4,5 | 5,5 | 24.40 p/u | 100093706 | 11 | 33.20 p/u |
| 100062074 | 11 | 12 | 28.20 p/u | 100093705 | 12,5 | 33.20 p/u |
| 100062086 | 12,5 | 13,5 | 30.86 p/u | | | |

pro-part Li

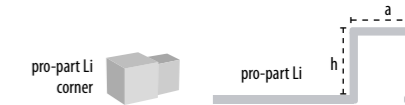
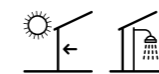

High gloss aluminium

| SAP | h (mm) | a (mm) | P/EU | SAP | h (mm) | P/EU |
|-----------|--------|--------|-----------|-----------|--------|-----------|
| 100062072 | 11 | 10 | 58.04 p/u | 100102763 | 11 | 14.92 p/u |
| 100062073 | 12,5 | 11,5 | 62.43 p/u | 100102762 | 12,5 | 18.14 p/u |

pro-part Li brushed

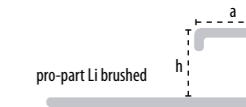

Brushed anodized aluminium

| SAP | h (mm) | a (mm) | P/EU |
|-----------|--------|--------|-----------|
| 100159084 | 11 | 12 | 64.33 p/u |
| 100159083 | 12,5 | 13,5 | 61.63 p/u |

pro-part

Decorative profile for ceramic wall and floor tiles. Suitable for trimming corners and transitions between ceramic tiles.

Right angle, corner shaped profiles, with an 8 mm edge and a variable width edge. Excellent solution for a wide variety of ceramic installations.

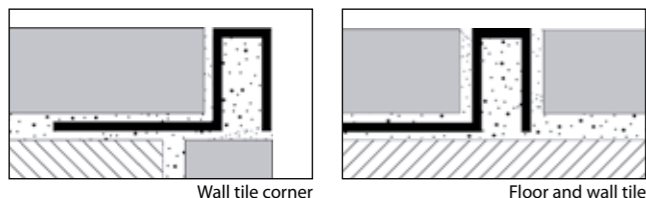

pro-part

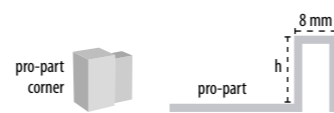

| Chromed brass | | | Chromed brass corner | | |
|---------------|--------|-----------|----------------------|--------|-----------|
| SAP | h (mm) | P/EU | SAP | h (mm) | P/EU |
| 100005368 | 7 | 87.54 p/u | 100005373 | 7 | 31.82 p/u |
| 100005369 | 9 | 90.98 p/u | 100005374 | 9 | 31.82 p/u |
| 100088905 | 10 | 92.42 p/u | 100091065 | 10 | 30.95 p/u |
| 100005370 | 11 | 94.44 p/u | 100005375 | 11 | 31.82 p/u |
| 100005371 | 12,5 | 97.45 p/u | 100005376 | 12,5 | 31.82 p/u |

pro-part

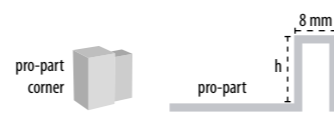

| Anodized aluminium silver | | | Anodized aluminium silver corner | | |
|---------------------------|--------|-----------|----------------------------------|--------|-----------|
| SAP | h (mm) | P/EU | SAP | h (mm) | P/EU |
| 100005322 | 7 | 20.03 p/u | 100005336 | 7 | 27.01 p/u |
| 100005323 | 9 | 21.10 p/u | 100005337 | 9 | 27.01 p/u |
| 100005324 | 11 | 22.16 p/u | 100005338 | 11 | 27.01 p/u |
| 100005325 | 12,5 | 24.32 p/u | 100005339 | 12,5 | 27.01 p/u |
| 100005326 | 15 | 32.40 p/u | | | |

pro-part

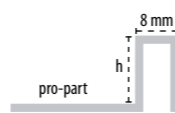
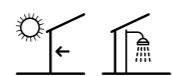

| Lacquered aluminium | | | White matt aluminium | | |
|---------------------|------------|-----------|----------------------|--------|-----------|
| SAP | h (mm) | P/EU | SAP | h (mm) | P/EU |
| 100088551 | Black 11 | 36.43 p/u | 100332940 | 9 | 32.80 p/u |
| 100080530 | Black 12,5 | 37.76 p/u | 100296752 | 11 | 36.43 p/u |
| 100100723 | White 11 | 36.43 p/u | 100286598 | 12,5 | 37.76 p/u |
| 100083438 | White 12,5 | 37.76 p/u | | | |

High gloss aluminium

| KEA | SAP | h (mm) | P/EU | SAP | h (mm) | P/EU |
|-----|-----------|--------|-----------|-----------|--------|-----------|
| | 100089004 | 11 | 73.51 p/u | 100220100 | 7 | 36.94 p/u |
| | 100005353 | 12,5 | 73.51 p/u | 100325883 | 9 | 37.50 p/u |
| | | | | 100171975 | 11 | 38.09 p/u |
| | | | | 100220083 | 12,5 | 39.23 p/u |

Black matt aluminium

| SAP | h (mm) | P/EU |
|-----------|--------|-----------|
| 100220100 | 7 | 36.94 p/u |
| 100325883 | 9 | 37.50 p/u |
| 100171975 | 11 | 38.09 p/u |
| 100220083 | 12,5 | 39.23 p/u |



pro-part

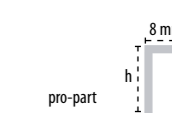
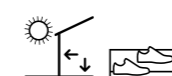

| Gloss polished gold brass | | |
|---------------------------|--------|-----------|
| SAP | h (mm) | P/EU |
| 100005362 | 9 | 53.35 p/u |
| 100005363 | 11 | 74.78 p/u |
| 100005364 | 12,5 | 77.22 p/u |

pro-part

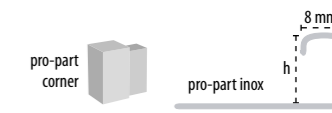

| Stainless natural steel | | | Stainless steel corner | | |
|-------------------------|--------|-----------|------------------------|--------|-----------|
| SAP | h (mm) | P/EU | SAP | h (mm) | P/EU |
| 100005377 | 9 | 39.22 p/u | 100005380 | 9 | 28.90 p/u |
| 100005378 | 11 | 41.98 p/u | 100005381 | 11 | 28.90 p/u |
| 100005379 | 12,5 | 46.78 p/u | 100005382 | 12,5 | 31.21 p/u |

pro-mate 45

Rounded profile for protecting wall tiles corners.

These profiles are the classic solution for protecting corners in wall tile coverings. Available in a wide variety of materials, its main feature is being shock-resistant.

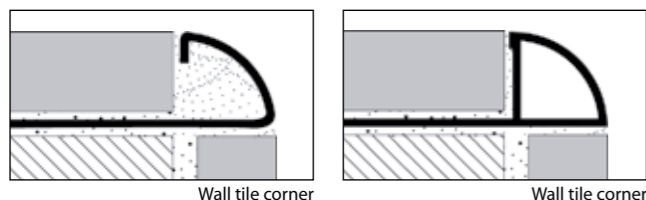

pro-mate 45 Top

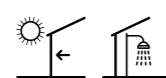

| Chromed brass | | |
|---------------|--------|-----------|
| SAP | h (mm) | P/EU |
| 100126778 | 6 | 79.93 p/u |
| 100099965 | 10 | 79.70 p/u |
| 100128801 | 12,5 | 99.04 p/u |

| Anodized aluminium silver | | |
|---------------------------|--------|-----------|
| SAP | h (mm) | P/EU |
| 100126777 | 6 | 28.20 p/u |

pro-mate 45 brass

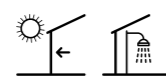

| Chromed brass | | |
|---------------|--------|-----------|
| SAP | h (mm) | P/EU |
| 100126776 | 6 | 81.99 p/u |
| 100099963 | 10 | 92.53 p/u |
| 100099964 | 12,5 | 98.90 p/u |

pro-mate 45 stainless steel

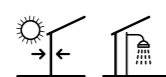

| Stainless steel V2A | | |
|---------------------|--------|-----------|
| SAP | h (mm) | P/EU |
| 100005156 | 8 | 38.28 p/u |
| 100005157 | 10 | 85.13 p/u |
| 100005158 | 12,5 | 49.36 p/u |

pro-mate 45 aluminio

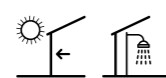

| Anodized aluminium silver | | |
|---------------------------|--------|-----------|
| SAP | h (mm) | P/EU |
| 100005094 | 10 | 19.28 p/u |
| 100005096 | 12,5 | 21.22 p/u |

| Lacquered aluminium | | |
|---------------------|------------|-----------|
| SAP | h (mm) | P/EU |
| 100005113 | White 10 | 22.03 p/u |
| 100005117 | White 12,5 | 23.87 p/u |

| High gloss aluminium | | |
|----------------------|--------|-----------|
| SAP | h (mm) | P/EU |
| 100096222 | 10 | 35.09 p/u |
| 100100665 | 12,5 | 36.71 p/u |

pro-corner

Metallic profile for protecting corners.

Right angle, metallic profiles for protecting corners. Most of the pro-corner models are installed after the tile, which implies a small lip over the tile surface.

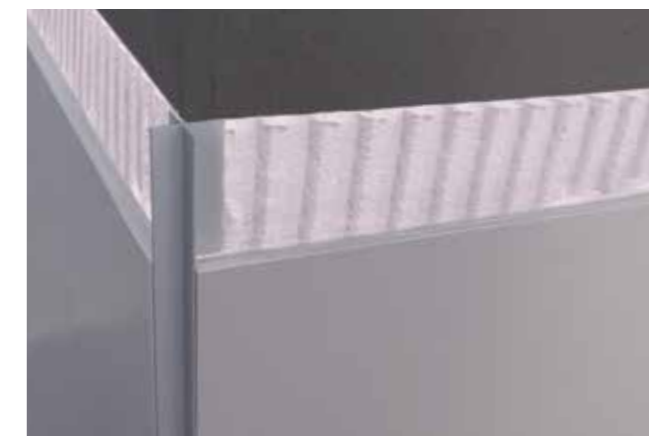
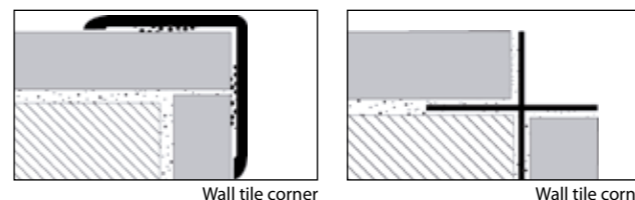

pro-corner P

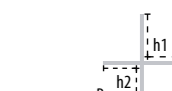
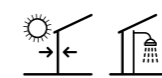

| Aluminium | | | | |
|-----------|------------|---------|---------|-----------|
| SAP | | h1 (mm) | h2 (mm) | P/EU |
| 100158001 | High gloss | 15 | 12 | 94.31 p/u |
| 100158002 | Silver | 15 | 12 | 83.24 p/u |
| 100213125 | Black | 15 | 12 | 96.40 p/u |

pro-corner R

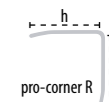
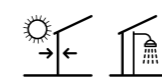

| Gloss stainless steel | | |
|-----------------------|--------|-----------|
| SAP | h (mm) | P/EU |
| 100005623 | 25 | 68.39 p/u |

pro-corner B

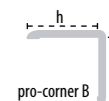
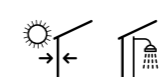

| Aluminium | | |
|-----------|--------|-----------|
| SAP | h (mm) | P/EU |
| 100005584 | 25 | 29.60 p/u |

3 meter profiles

Profiles available in different shapes, from right-angled profiles for straight trims to rounded shape profiles.



Wall tile corner

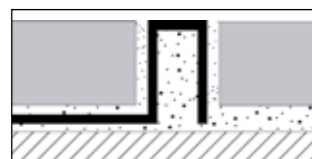

Wall tile



pro-mate 2

| SAP | | h (mm) | P/EU |
|-----------|----------|--------|-----------|
| 100276385 | Inox V2A | 11 | 39.49 p/u |
| 100276386 | Inox V2A | 12,5 | 40.95 p/u |

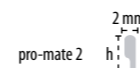

pro-mate 3

| SAP | | h (mm) | P/EU |
|-----------|-------------|--------|-----------|
| 100286309 | Chrome | 12,5 | 89.35 p/u |
| 100276187 | Alum. anod. | 11 | 23.29 p/u |
| 100276196 | Alum. anod. | 12,5 | 23.65 p/u |
| 100286597 | Alum. black | 12,5 | 36.31 p/u |

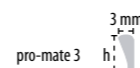

pro-mate 5

| SAP | | h (mm) | P/EU |
|-----------|--------|--------|------------|
| 100286603 | Chrome | 11 | 101.46 p/u |

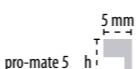

pro-part

| SAP | | h (mm) | P/EU |
|-----------|--------|--------|------------|
| 100286618 | Chrome | 11 | 116.44 p/u |
| 100286360 | Chrome | 12,5 | 116.94 p/u |

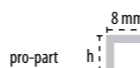

pro-part Li

| SAP | | h (mm) | P/EU |
|-----------|--------------|--------|-----------|
| 100276440 | Inox V2A | 11 | 53.82 p/u |
| 100276480 | Inox V2A | 12,5 | 58.81 p/u |
| 100276510 | Inox. brillo | 11 | 59.54 p/u |
| 100276459 | Inox. brillo | 12,5 | 76.19 p/u |
| 100276492 | Inox. cep. | 12,5 | 76.19 p/u |
| 100276208 | Alum. anod. | 11 | 32.39 p/u |
| 100276198 | Alum. anod. | 12,5 | 35.85 p/u |

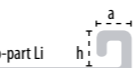

pro-mate 45

| SAP | | h (mm) | P/EU |
|-----------|------------------|--------|-----------|
| 100276415 | PVC white | 11 | 7.39 p/u |
| 100276371 | Inox. | 10 | 50.99 p/u |
| 100276372 | Inox. | 12,5 | 53.62 p/u |
| 100276367 | Alum. anod. | 10 | 24.95 p/u |
| 100276299 | Alum. anod. | 12,5 | 28.72 p/u |
| 100276352 | Alum. lac. white | 11 | 31.14 p/u |
| 100276319 | Alum. lac. white | 12,5 | 32.91 p/u |





pro-T

Profile for transitions between floor or wall coverings.

Profiles for transitions between tiles or slabs with slightly different heights. Available in two widths: 14 and 25 mm.

Specially recommended for transitions between ceramic tiles and wooden floors.

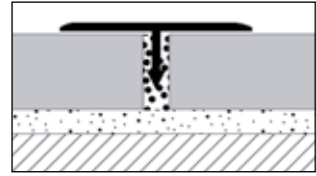

Floor tile



pro-T

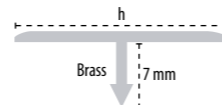

Chromed brass

| SAP | h (mm) | P/EU |
|-----------|--------|-----------|
| 100005460 | 14 | 52.35 p/u |
| 100005461 | 25 | 69.36 p/u |

pro-T

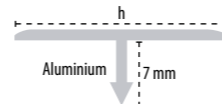

Anodized aluminium silver

| SAP | h (mm) | P/EU |
|-----------|--------|-----------|
| 100005452 | 14 | 9.78 p/u |
| 100005453 | 25 | 17.88 p/u |

pro-T

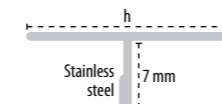

Gloss stainless steel

| SAP | h (mm) | P/EU |
|-----------|--------|-----------|
| 100005462 | 14 | 44.78 p/u |
| 100005463 | 25 | 62.85 p/u |

Brushed stainless steel

| SAP | h (mm) | P/EU |
|-----------|--------|-----------|
| 100005464 | 14 | 61.92 p/u |
| 100005465 | 25 | 79.82 p/u |

pro-level

Transition profile between floor coverings at different levels. It covers the non-glazed edge of the tile and protects it from shocks.

Technical profiles for small height differences between floor coverings. Available in rounded finish and sloped finish. Specially recommended for high transit floors.

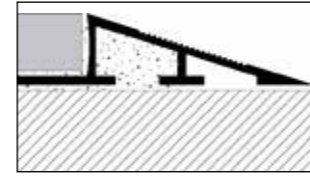

Floor tile

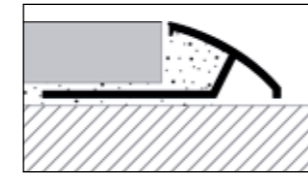

Floor tile



pro-level C

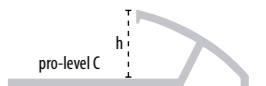

Anodized aluminium silver

| SAP | h (mm) | P/EU |
|-----------|--------|-----------|
| 100005426 | 11 | 23.97 p/u |
| 100005427 | 12,5 | 32.05 p/u |

pro-level R



Anodized aluminium silver

| SAP | h (mm) | P/EU |
|-----------|--------|-----------|
| 100005428 | 11 | 64.80 p/u |
| 100005429 | 12,5 | 71.21 p/u |
| 100005430 | 15 | 76.61 p/u |
| 100005431 | 20 | 84.37 p/u |

pro-shower

New range of profiles for shower trays. Designed to cover the sides of shower trays; specially for shower with only one direction slope. There are also special trims for installing glass screens.

These profiles are made of stainless steel and are available in two different finishings: gloss and brushed.

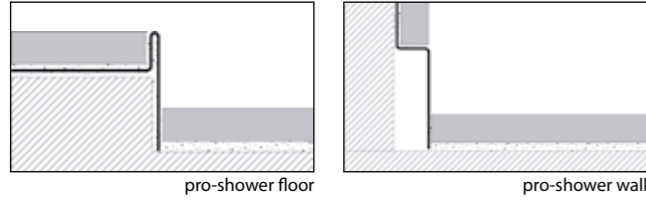

pro-shower floor



| Chromed stainless steel | | | | Brushed stainless steel | | | | | |
|-------------------------|------------|---------|---------|-------------------------|-----------|------------|---------|------|-------------------|
| SAP | | h1 (mm) | h2 (mm) | P/EU | SAP | h1 (mm) | h2 (mm) | P/EU | |
| 100159068 | Left side | 12,5 | 24 | 95.03 p/u | 100159067 | Left side | 12,5 | 32 | 124.92 p/u |
| 100160219 | Right side | 12,5 | 24 | 95.03 p/u | 100160218 | Right side | 12,5 | 32 | 124.92 p/u |
| 100159069 | Left side | 12,5 | 32 | 150.07 p/u | | | | | |
| 100160280 | Right side | 12,5 | 32 | 150.07 p/u | | | | | |

Profile length h2=24 980 mm
Profile length h2=32 1480 mm

Profile length h2=32 1480 mm

pro-shower wall



| Chromed stainless steel | | | | Brushed stainless steel | | | | | |
|-------------------------|------------|---------|---------|-------------------------|-----------|------------|---------|------|-------------------|
| SAP | | h1 (mm) | h2 (mm) | P/EU | SAP | h1 (mm) | h2 (mm) | P/EU | |
| 100159100 | Left side | 12,5 | 32 | 150.07 p/u | 100159088 | Left side | 12,5 | 32 | 124.92 p/u |
| 100160248 | Right side | 12,5 | 32 | 150.07 p/u | 100160246 | Right side | 12,5 | 32 | 124.92 p/u |

Profile length h2=32 1480 mm

Profile length h2=32 1480 mm

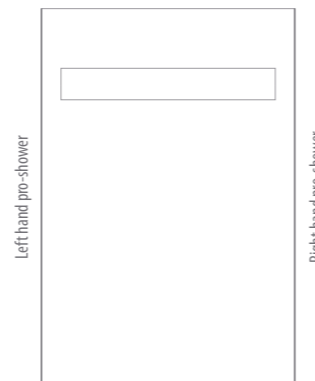

pro-sanit

Concave profile for installation where walls and floors meet or between wall coverings and bathtubs, shower trays or other bath elements. It substitutes the traditional curve ceramic piece.

It reduces the risk of water leakage and eases cleaning and preservation of angles between floor and wall coverings.

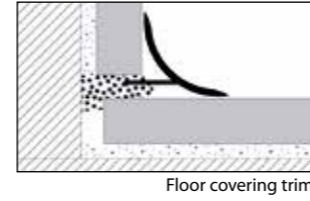

pro-sanit U1



| High gloss aluminum | | |
|---------------------|--------|------------------|
| SAP | h (mm) | P/EU |
| 100062075 | 16 | 35.99 p/u |
| 100062076 | 22 | 41.07 p/u |

| Anodized aluminium silver | | |
|---------------------------|--------|------------------|
| SAP | h (mm) | P/EU |
| 100062077 | 16 | 15.56 p/u |
| 100062078 | 22 | 19.48 p/u |

| Lacquered aluminium | | | |
|---------------------|-------|--------|------------------|
| SAP | | h (mm) | P/EU |
| 100062079 | white | 16 | 21.78 p/u |
| 100062080 | white | 22 | 27.24 p/u |

pro-sanit U2

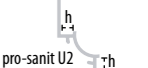

| Stainless steel | | | | Stainless steel corner | | | |
|-----------------|---------|--------|------------------|------------------------|------------------|------|------------------|
| SAP | | h (mm) | P/EU | SAP | h (mm) | P/EU | |
| 100005566 | Gloss | 12,5 | 71.63 p/u | 100005567 | Gloss outer | 12,5 | 11.70 p/u |
| 100005569 | Brushed | 12,5 | 96.69 p/u | 100005568 | Gloss inner | 12,5 | 11.70 p/u |
| | | | | 100005570 | Brushed outer | 12,5 | 11.70 p/u |
| | | | | 100005571 | Brushed internal | 12,5 | 11.70 p/u |

pro-sanit U2

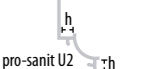

| PVC | | | |
|-----------|-------|---------|------------------|
| SAP | | h (mm) | P/EU |
| 100005542 | white | 11 x 11 | 21.73 p/u |

pro-dilata

Profile for movement joints in ceramic wall and floor coverings.

PVC profiles with a central elastic joint for the absorption of tensions in the ceramic floor. Available in several colours and joint widths, they are the best solution for creating intermediate movement joints.

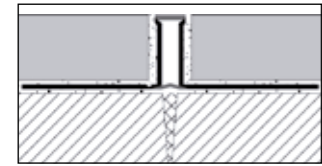
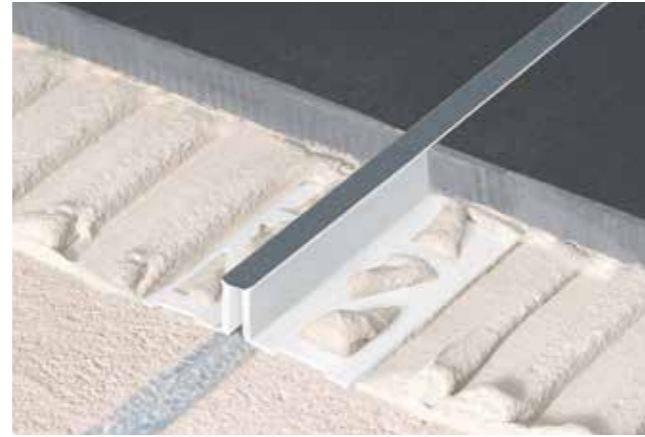

Floor tile

pro-dilata PVC

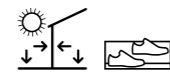

| CFL 8 mm | | | |
|-----------|-------|--------|-----------|
| SAP | | h (mm) | P/EU |
| 100005685 | White | 12,5 | 15.23 p/u |
| 100005682 | Beige | 10 | 15.20 p/u |
| 100005686 | Beige | 12,5 | 15.23 p/u |
| 100005690 | Beige | 15 | 19.63 p/u |
| 100005683 | Black | 10 | 15.20 p/u |
| 100005687 | Black | 12,5 | 15.23 p/u |
| 100005691 | Black | 15 | 19.63 p/u |
| 100005684 | Grey | 10 | 15.20 p/u |
| 100005688 | Grey | 12,5 | 15.23 p/u |
| 100005692 | Grey | 15 | 19.63 p/u |

pro-dilata PVC

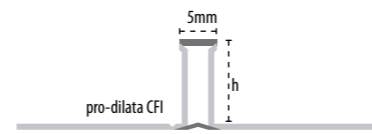
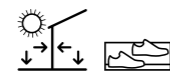

| CFI 5 mm | | | |
|-----------|------------|--------|-----------|
| SAP | | h (mm) | P/EU |
| 100316178 | Light grey | 9 | 15.10 p/u |
| 100159078 | Light grey | 11 | 15.50 p/u |
| 100159080 | Light grey | 12,5 | 15.94 p/u |
| 100316191 | Grey | 9 | 15.10 p/u |
| 100159076 | Grey | 11 | 15.50 p/u |
| 100159077 | Grey | 12,5 | 15.94 p/u |
| 100316182 | Black | 9 | 15.10 p/u |
| 100159081 | Black | 11 | 15.50 p/u |
| 100159082 | Black | 12,5 | 15.94 p/u |
| 100316183 | Beige | 9 | 15.10 p/u |
| 100159074 | Beige | 11 | 15.50 p/u |
| 100159075 | Beige | 12,5 | 15.94 p/u |

pro-dilata

Profile for movement joints in ceramic floor coverings.

Metal profiles with a central elastic joint for the absorption of tensions in the ceramic floor. New pro-dilata is a 8 and 10 mm wide precast expansion joint for indoor and outdoor ceramic floors.

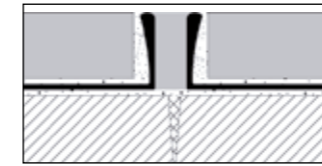

Floor tile

pro-dilata stainless steel

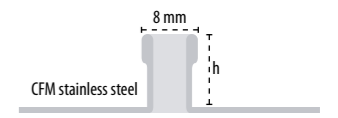
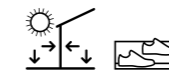

| CFM 8 mm | | |
|-----------|--------|------------|
| SAP | h (mm) | P/EU |
| 100005714 | 10 | 112.60 p/u |
| 100005715 | 12,5 | 100.35 p/u |
| 100005716 | 15 | 118.01 p/u |
| 100005717 | 20 | 134.99 p/u |

pro-dilata stainless steel nc

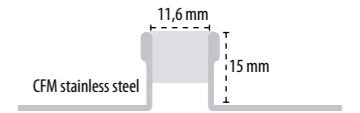
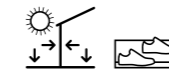

| CFM 11,6 mm | | |
|-------------|--------|------------|
| SAP | h (mm) | P/EU |
| 100280152 | 15 | 116.93 p/u |

pro-dilata aluminium

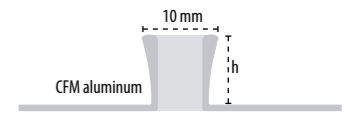
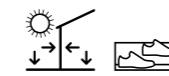

| CFM 10 mm | | |
|-----------|--------|-----------|
| SAP | h (mm) | P/EU |
| 100005698 | 10 | 74.60 p/u |
| 100005699 | 12,5 | 60.44 p/u |
| 100005700 | 15 | 63.47 p/u |
| 100005702 | 20 | 88.10 p/u |

structural joints

Profile for structural joints in ceramic floor coverings.

Metallic profiles with a central elastic joint that absorbs the structural movements of the support. Available with deformable polypropylene joint for pedestrian transit and moving metallic joint for wheeled transit.

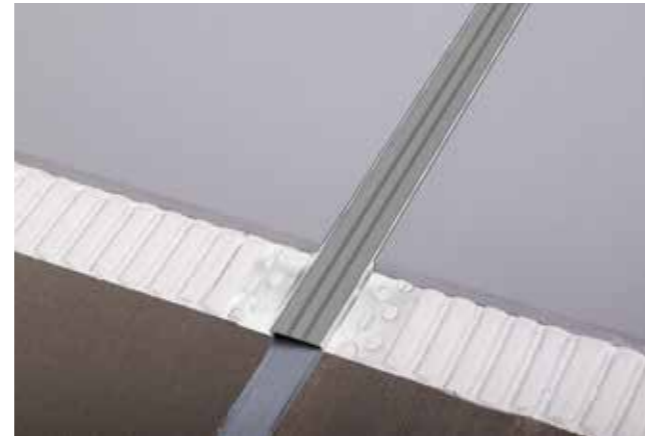
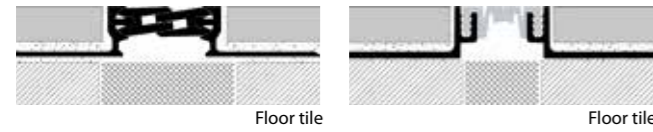

structural joints BT

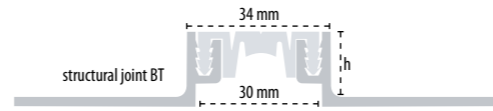
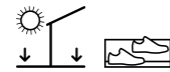

| BT-34 | | | |
|-----------|------|--------|------------|
| SAP | | h (mm) | P/EU |
| 100332105 | Gris | 22 | 273.14 p/u |
| 100332093 | Gris | 40 | 327.80 p/u |

Accepted traffic: Pedestrian and vehicles with pneumatic wheels up to 35 kN.

structural joints AT

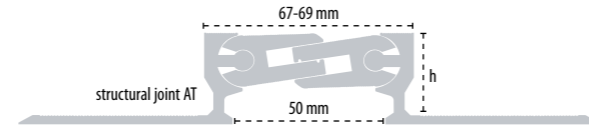
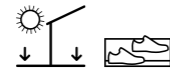

| AT-50 | | | |
|-----------|--|--------|------------|
| SAP | | h (mm) | P/EU |
| 100324422 | | 22 | 447.52 p/u |
| 100324431 | | 50 | 631.66 p/u |

Accepted traffic: Pedestrian, vehicles with pneumatic wheels up to 300 kN and forklift trucks or solid wheeled hand pallet trucks up to 9 kg/mm.

pro-step

Profile for the making of stair steps. It substitutes the traditional step ceramic piece by a combination of ceramic tile and profile.

Metallic profiles that cover the non-glazed edge of the tile, protect it from shocks and reduce the risk of slipping.

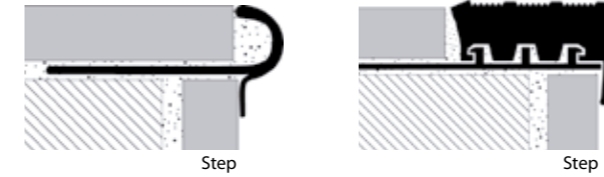

pro-step

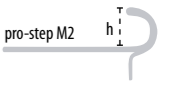
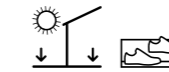

| Stainless steel M2 | | | |
|--------------------|--|--------|-----------|
| SAP | | h (mm) | P/EU |
| 100005523 | | 11 | 62.62 p/u |

pro-step

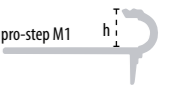
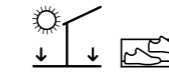

| Anodized aluminium silver M1 | | | |
|------------------------------|--|--------|-----------|
| SAP | | h (mm) | P/EU |
| 100005509 | | 11 | 25.70 p/u |
| 100067688 | | 13,5 | 25.25 p/u |

pro-step

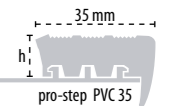
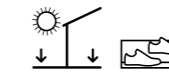

| PVC 35 | | | |
|-----------|------|--------|-----------|
| SAP | | h (mm) | P/EU |
| 100005482 | Grey | 11 | 51.52 p/u |

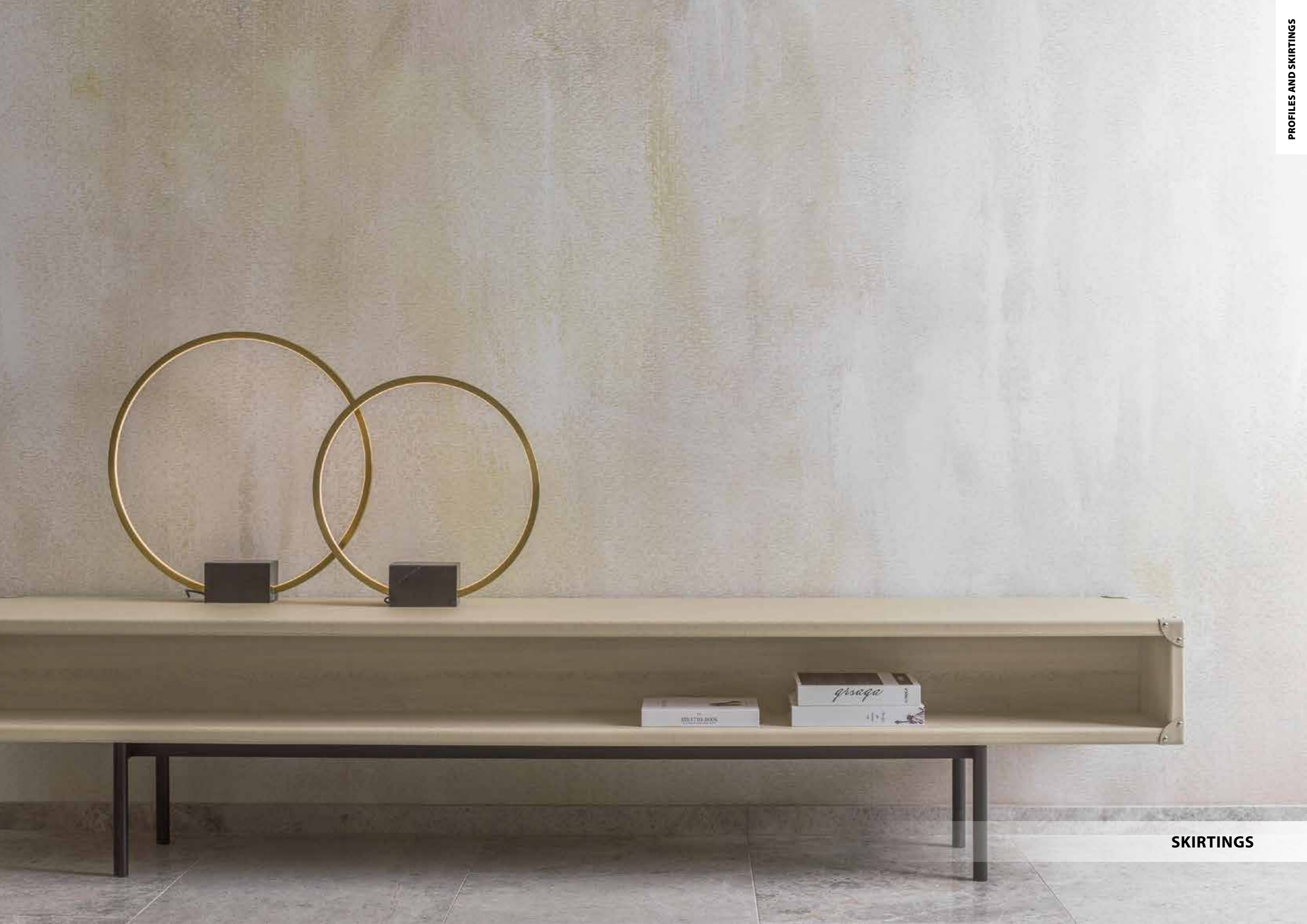

SKIRTINGS

Metal profiles. They replace traditional ceramic skirting. Specially recommended for shops and public buildings.



pro-skirting black



pro-skirting white



pro-skirting silver

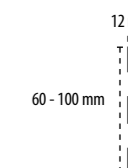

pro-skirting black

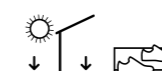

| pro-skirting black | | | pro-skirting corner black | | |
|--------------------|----------------|------------------|---------------------------|--------------|------------------|
| SAP | | P/EU | SAP | | P/EU |
| 100213522 | 12x60x2500 mm | 33.84 p/u | 100213153 | 12x60x12 mm | 11.75 p/u |
| 100225511 | 12x100x2500 mm | 48.94 p/u | 100236020 | 12x100x12 mm | 12.84 p/u |

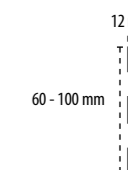

pro-skirting white

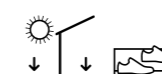

| pro-skirting white | | | pro-skirting corner white | | |
|--------------------|----------------|------------------|---------------------------|--------------|------------------|
| SAP | | P/EU | SAP | | P/EU |
| 100213533 | 12x60x2500 mm | 31.94 p/u | 100213200 | 12x60x12 mm | 11.75 p/u |
| 100225498 | 12x100x2500 mm | 48.94 p/u | 100235979 | 12x100x12 mm | 12.84 p/u |

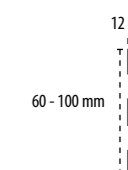

pro-skirting silver



| pro-skirting silver | | | pro-skirting corner silver | | |
|---------------------|----------------|------------------|----------------------------|--------------|------------------|
| SAP | | P/EU | SAP | | P/EU |
| 100213532 | 12x60x2500 mm | 33.84 p/u | 100213199 | 12x60x12 mm | 11.75 p/u |
| 100225479 | 12x100x2500 mm | 49.36 p/u | 100235986 | 12x100x12 mm | 12.84 p/u |

Fixing clips pro-skirting

| SAP | | P/EU |
|-----------|----------------|--------------------|
| 100193608 | 17x30 mm 50 ud | 15.80 p/bag |

Profile length: 2500 mm



pro-skirting silver



PRO-SKIRTING CUSTOMIZED

Decorative skirtings for PAR-KER tiles by PORCELANOSA. LIFESTYLE design.

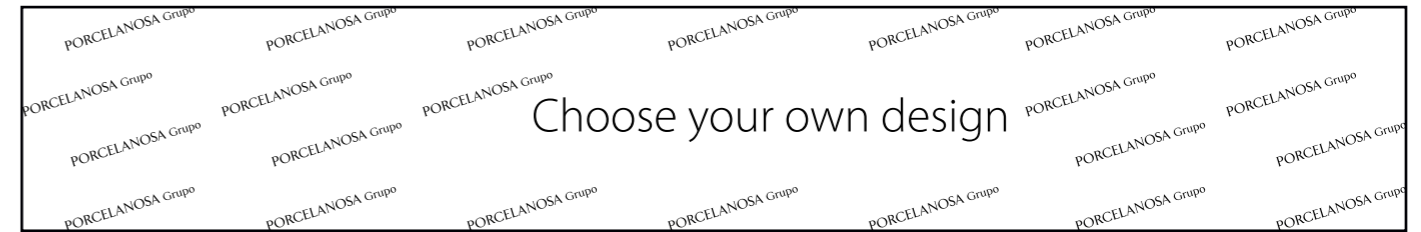

pro-skirting customized

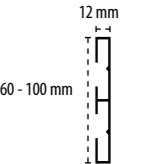
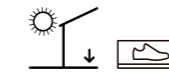

Customized metal profiles with any Porcelanosa Group finish. Butech expands the pro-skirting range by providing solutions for all types of tile flooring. Besides the existing silver, black and white options, new customized skirting boards can be produced with the same finish of any PORCELANOSA Group tile collection. Wood, concretes, stones, marbles, metallics, solid colours, hydraulic pattern.

| pro-skirting customized | | | pro-skirting corner customized | | |
|-------------------------|----------------|------------------|--------------------------------|--------------|-------------------|
| SAP | | P/EU | SAP | | P/EU |
| 100306733 | 12x60x1800 mm | 36.49 p/u | 100307574 | 12x60x12 mm | 13.88 p/2u |
| 100306689 | 12x100x1800 mm | 47.36 p/u | 100306797 | 12x100x12 mm | 13.88 p/2u |

| Fixing clips pro-skirting customized | | |
|--------------------------------------|----------------|--------------------|
| SAP | | P/EU |
| 100193608 | 17x30 mm 50 ud | 15.80 p/bag |

Profile length: 1800 mm

PRO-SKIRTING PAR-KER

Decorative skirtings for PAR-KER tiles by PORCELANOSA.
LIFESTYLE design.



pro-skirting Oxford Acero

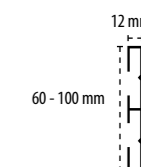

pro-skirting Oxford

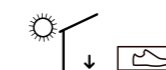

| pro-skirting Oxford Acero | | | pro-skirting corner Oxford Acero | | |
|-------------------------------|----------------|-----------|--------------------------------------|--------------|------------|
| SAP | | P/EU | SAP | | P/EU |
| 100193645 | 12x60x1800 mm | 36.05 p/u | 100233474 | 12x60x12 mm | 13.94 p/2u |
| 100178475 | 12x100x1800 mm | 47.36 p/u | 100233572 | 12x100x12 mm | 13.94 p/2u |
| pro-skirting Oxford Antracita | | | pro-skirting corner Oxford Antracita | | |
| SAP | | P/EU | SAP | | P/EU |
| 100193646 | 12x60x1800 mm | 36.05 p/u | 100233460 | 12x60x12 mm | 13.94 p/2u |
| 100178471 | 12x100x1800 mm | 47.36 p/u | 100233528 | 12x100x12 mm | 13.94 p/2u |
| pro-skirting Oxford Cognac | | | pro-skirting corner Oxford Cognac | | |
| SAP | | P/EU | SAP | | P/EU |
| 100193547 | 12x60x1800 mm | 36.05 p/u | 100233453 | 12x60x12 mm | 13.94 p/2u |
| 100178437 | 12x100x1800 mm | 47.36 p/u | 100233563 | 12x100x12 mm | 13.94 p/2u |
| pro-skirting Oxford Natural | | | pro-skirting corner Oxford Natural | | |
| SAP | | P/EU | SAP | | P/EU |
| 100193598 | 12x60x1800 mm | 36.05 p/u | 100233438 | 12x60x12 mm | 13.94 p/2u |
| 100178462 | 12x100x1800 mm | 47.36 p/u | 100233547 | 12x100x12 mm | 13.94 p/2u |
| pro-skirting Oxford Blanco | | | pro-skirting corner Oxford Blanco | | |
| SAP | | P/EU | SAP | | P/EU |
| 100193597 | 12x60x1800 mm | 36.05 p/u | 100233470 | 12x60x12 mm | 13.94 p/2u |
| 100178436 | 12x100x1800 mm | 47.36 p/u | 100233562 | 12x100x12 mm | 13.94 p/2u |

Fixing clips pro-skirting PAR-KER

| SAP | | P/EU |
|-----------|----------------|-------------|
| 100193608 | 17x30 mm 50 ud | 15.80 p/bag |

Profile length: 1800 mm

PRO-SKIRTING PAR-KER

Decorative skirtings for PAR-KER tiles by PORCELANOSA.
LIFESTYLE design.



pro-skirting Ascot Teca

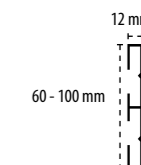

pro-skirting Ascot

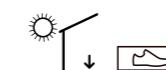

pro-skirting Ascot Teca

| SAP | Dimensions | P/EU |
|-----------|----------------|------------------|
| 100193642 | 12x60x1800 mm | 36.05 p/u |
| 100178466 | 12x100x1800 mm | 47.36 p/u |

pro-skirting corner Ascot Teca

| SAP | Dimensions | P/EU |
|-----------|--------------|-------------------|
| 100233495 | 12x60x12 mm | 13.94 p/2u |
| 100233581 | 12x100x12 mm | 13.94 p/2u |

pro-skirting Ascot Arce

| SAP | Dimensions | P/EU |
|-----------|----------------|------------------|
| 100193595 | 12x60x1800 mm | 36.05 p/u |
| 100178480 | 12x100x1800 mm | 47.36 p/u |

pro-skirting corner Ascot Arce

| SAP | Dimensions | P/EU |
|-----------|--------------|-------------------|
| 100233408 | 12x60x12 mm | 13.94 p/2u |
| 100233565 | 12x100x12 mm | 13.94 p/2u |

Fixing clips pro-skirting PAR-KER

| SAP | Dimensions | P/EU |
|-----------|----------------|--------------------|
| 100193608 | 17x30 mm 50 ud | 15.80 p/bag |

Profile length: 1800 mm

pro-skirting Ascot Teca

PRO-SKIRTING PAR-KER

Decorative skirtings for PAR-KER tiles by PORCELANOSA.
LIFESTYLE design.



pro-skirting Manhattan Colonial

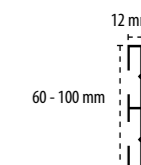

pro-skirting Manhattan



| pro-skirting Manhattan Colonial | | | pro-skirting corner Manhattan Colonial | | |
|---------------------------------|----------------|------------------|--|--------------|-------------------|
| SAP | | P/EU | SAP | | P/EU |
| 100193603 | 12x60x1800 mm | 36.05 p/u | 100233574 | 12x60x12 mm | 13.94 p/2u |
| 100189248 | 12x100x1800 mm | 47.36 p/u | 100233555 | 12x100x12 mm | 13.94 p/2u |
| pro-skirting Manhattan Maple | | | pro-skirting corner Manhattan Maple | | |
| SAP | | P/EU | SAP | | P/EU |
| 100193604 | 12x60x1800 mm | 36.05 p/u | 100233398 | 12x60x12 mm | 13.94 p/2u |
| 100191461 | 12x100x1800 mm | 47.36 p/u | 100233499 | 12x100x12 mm | 13.94 p/2u |
| pro-skirting Manhattan Cognac | | | pro-skirting corner Manhattan Cognac | | |
| SAP | | P/EU | SAP | | P/EU |
| 100193602 | 12x60x1800 mm | 36.05 p/u | 100233621 | 12x60x12 mm | 13.94 p/2u |
| 100191470 | 12x100x1800 mm | 47.36 p/u | 100233517 | 12x100x12 mm | 13.94 p/2u |

Fixing clips pro-skirting PAR-KER

| SAP | | P/EU |
|-----------|----------------|--------------------|
| 100193608 | 17x30 mm 50 ud | 15.80 p/bag |

Profile length: 1800 mm

pro-skirting Manhattan Colonial

PRO-SKIRTING PAR-KER

Decorative skirtings for PAR-KER tiles by PORCELANOSA.
LIFESTYLE design.



pro-skirting Delaware Acero

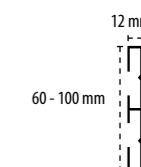

pro-skirting Delaware



| pro-skirting Delaware Natural | | | pro-skirting corner Delaware Natural | | |
|-------------------------------|----------------|-------------|--------------------------------------|--------------|-------------|
| SAP | | P/EU | SAP | | P/EU |
| 100226719 | 12x60x1800 mm | 36.05 p/u | 100233593 | 12x60x12 mm | 13.94 p/2u |
| 100222010 | 12x100x1800 mm | 47.36 p/u | 100233552 | 12x100x12 mm | 13.94 p/2u |
| pro-skirting Delaware Nogal | | | pro-skirting corner Delaware Nogal | | |
| SAP | | P/EU | SAP | | P/EU |
| 100226740 | 12x60x1800 mm | 36.05 p/u | 100233612 | 12x60x12 mm | 13.94 p/2u |
| 100222027 | 12x100x1800 mm | 47.36 p/u | 100233536 | 12x100x12 mm | 13.94 p/2u |

Fixing clips pro-skirting PAR-KER

| | | |
|------------|----------------|-------------|
| SAP | | P/EU |
| 100193608 | 17x30 mm 50 ud | 15.80 p/bag |

Profile length: 1800 mm



pro-skirting Nobu Arce

PRO-SKIRTING PAR-KER

Decorative skirtings for PAR-KER tiles by PORCELANOSA.
LIFESTYLE design.



pro-skirting Nobu Arce

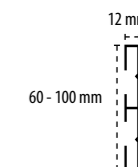

pro-skirting Nobu

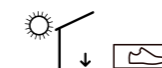

pro-skirting Nobu Arce

| SAP | Dimensions | P/EU |
|-----------|----------------|-----------|
| 100243369 | 12x60x1800 mm | 35.19 p/u |
| 100243412 | 12x100x1800 mm | 47.36 p/u |

pro-skirting Nobu Roble

| SAP | Dimensions | P/EU |
|-----------|----------------|-----------|
| 100243440 | 12x60x1800 mm | 35.19 p/u |
| 100243420 | 12x100x1800 mm | 47.36 p/u |

Fixing clips pro-skirting PAR-KER

| SAP | Dimensions | Quantity | P/EU |
|-----------|------------|----------|-------------|
| 100193608 | 17x30 mm | 50 ud | 15.80 p/bag |

Profile length: 1800 mm

Metallic profiles for skirtings. They have a high mechanical resistance with a functional, modern design. Specially recommended for office floors and raised access floors.

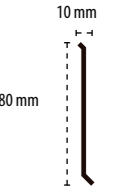

pro-plint stainless steel

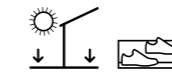

pro-plint stainless steel

| SAP | | P/EU |
|-----------|-----------|------------------|
| 100005635 | brillante | 48.66 p/u |
| 100005636 | cepillado | 57.30 p/u |

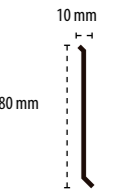

pro-plint anodized aluminium

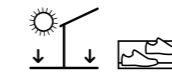

pro-plint anodized aluminium

| SAP | | P/EU |
|-----------|--------|------------------|
| 100073104 | Silver | 45.84 p/u |

pro-plint corner anodized aluminium

| SAP | | P/EU |
|-----------|----------|-----------------|
| 100073105 | Outer | 6.88 p/u |
| 100073106 | Internal | 8.32 p/u |

pro-plint lateral cap

| SAP | | P/EU |
|-----------|-------|-----------------|
| 100073107 | Right | 8.68 p/u |
| 100073108 | Left | 5.14 p/u |

pro-plint connection

| SAP | P/EU |
|-----------|-----------------|
| 100073109 | 8.03 p/u |



pro-plint stainless steel

Profile length: 2500 mm



ADHESIVES

CEMENT-BASED ADHESIVES

tixocem plus, **112** | flexitec n, **113** | fr-one n, **114** | maxifluid, **115**
one-flex Premium, **116** | super-one n, **117** | super-flex S2, **118**

ADDITIVES FOR CEMENT-BASED ADHESIVES

r eco, **120** | unilax, **121**

REACTIVE RESINS ADHESIVES

politech n, **122** | politech Premium, **123**

WATER-BASED ADHESIVE

linkfloor fix, **124** | skins fix, **125**

POLYMER ADHESIVE

h-920, **126**

FAÇADE FIXINGS

Facade fixings, **128**
Concealed facade fixings, **129** | Visible facade fixings, **129**

tixocem plus

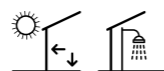

tixocem plus is a type C1TE cement-based adhesive as per EN 12004, suitable for laying absorbent ceramic tiles using the thin-bed method on cement, plasterboard substrates and for laying non-absorbent ceramic tiles on cement-based substrates. Specially recommended for laying porcelain tiles indoors.

It solves simply and effectively the laying of absorbent ceramic tiles on cement-based, plasterboard or brick supports. With this adhesive, tiles can be laid on a medium-bed layer on uneven substrates. It can be laid on thicknesses up to 10 mm. Waterproof and frost-resistant.

Certifications / Standards:

EN 12004 C1TE



Features:

- Cement-based, single component adhesive.
- Optimal workability. Thixotropic.
- Extended working times. Open time higher than 30 min.
- Application thickness up to 10 mm.
- Frost-resistant.
- Mixing water: 8 L per 25 kg bag

Recommended uses:

- Medium and small format wall tile coverings for indoor use.
- Medium format porcelain floor tile coverings for indoor use.
- Medium format floor tile coverings for indoor use.
- Uneven substrates.

Substrates:

- Cement-based screeds
- Cement render
- Anhydrite screeds, having previously applied **uniprim**
- Plasters, having previously applied **uniprim**
- Large-format ceramic brick
- Plasterboard panels

Materials:

- Medium and small format ceramic tiles
- High-absorption ceramic tiles and stoneware
- Porcelain tile

Coverage:

- Small format and mosaic / Trowel U4: 2-3 kg/m²
- Medium format / Trowels U6-U8: 3-5 kg/m²
- Large format / Trowels U10-U12: 5-7 kg/m²

*Approximate coverage according to laboratory tests.

Regardless of our recommendations for use indicated for this adhesive, respect the installation regulations in force in each country.

Before using this product in any application not indicated in this catalogue, please perform a test or refer to the product's technical sheet.

tixocem plus

| SAP | | Presentation | Europallet | P/EU |
|-----------|----------------|--------------|----------------|-----------|
| 100043280 | tixocem blanco | bag 25 kg | 1200 kg/pallet | 0.59 p/kg |

flexitec n

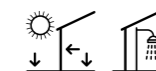

flexitec n is a type C2TE cement-based adhesive, suitable for laying porcelain tiles, on cement-based substrates or flexible substrates like plasterboard. Its excellent conditions of use make it especially recommendable.

A medium-elasticity cement-based adhesive for laying absorbent ceramic tiles, stoneware or porcelain tiles using the thin-bed method. Thixotropic.

Certifications/Standards:

EN 12004 C2TE
CSTB: 2454-222 MC 299 C2-E



Features:

- Cement-based, single component adhesive.
- Excellent adherence. Medium flexibility.
- Fine texture mortar, with excellent mixing and application features.
- High initial adherence and no sagging.
- Extended working times. Open time higher than 30 min.
- Application thickness up to 6 mm.
- Frost-resistant.
- Mixing water:
 - White: 7,25 - 7,75 l per 25 kg bag
 - Grey: 6,75 - 7,25 l per 25 kg bag

Recommended uses:

- Indoor wall tile coverings.
- Indoor and outdoor porcelain tile coverings.

Substrates:

- Cement-based screeds
- Cement render
- Concrete slabs and floors
- Anhydrite screeds, having previously applied **uniprim**
- Plasters, having previously applied **uniprim**
- Plasterboard panels

Materials:

- Medium and small format ceramic tiles
- High-absorption ceramic tiles and stoneware
- Porcelain tiles

Coverage:

- Small format and mosaic / Trowel U4: 2-3 kg/m²
- Medium format / Trowels U6-U8: 3-5 kg/m²
- Large format / Trowels U10-U12: 5-7 kg/m²

*Approximate coverage according to laboratory tests.

Regardless of our recommendations for use indicated for this adhesive, respect the installation regulations in force in each country.

Before using this product in any application not indicated in this catalogue, please perform a test or refer to the product's technical sheet.

flexitec n

| SAP | | Presentation | Europallet | P/EU |
|-----------|-------------------|--------------|----------------|-----------|
| 100004232 | flexitec n blanco | bag 25 kg | 1000 kg/pallet | 0.99 p/kg |
| 100004230 | flexitec n gris | bag 25 kg | 1000 kg/pallet | 0.94 p/kg |
| 100277878 | r-eco | bag 250 gr | | 1.31 p/u |

fr-one n

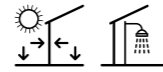

fr-one n is a type C2TE high-tech cement-based adhesive, as per EN 12004, for laying all kinds of ceramic tiles on the most used substrates in the building industry. Specially recommended for large format tiles and uneven substrates.

Advanced, high-performance, single-component, easy to use adhesive for laying all kinds of ceramic tiles. With this adhesive, tiles can be laid on a medium-bed layer on uneven substrates. It can be laid on thicknesses up to 15 mm. Specially recommended for porcelain floor tiles, antiqued marble, large formats and pools. Thixotropic.



Certifications/Standards:

EN 12004 C2TE
 CSTB: 2452-243 MC 301 C2-E



Features:

- Cement-based, single component adhesive.
- Excellent adherence.
- Optimal workability. Extended working times. Open time higher than 30 min.
- High initial adherence and no sagging.
- Application thickness up to 15 mm.
- Frost-resistant.
- Mixing water: 7 - 7.50 L per 25 kg bag

Recommended uses:

- Large format interior wall tiles
- Large format interior porcelain floor tiles and outdoor use
- Uneven substrates
- High traffic floor tiles
- Damp environments
- On bonded facades and pools, replace mixing water with **unilax** additive

Substrates:

- Cement-based screeds
- Cement render
- Concrete slabs and floors
- Anhydrite screeds, having previously applied **uniprim**
- Plasters, having previously applied **uniprim**
- Large-format ceramic brick
- Pre-existing tiles/mosaic/stones*
- Plasterboard panels

Materials:

- Large format ceramic tiles
- High-absorption ceramic tiles and stoneware
- Porcelain tiles
- Glass mosaic
- Natural stone and marble not prone to staining

Coverage:

- Small format and mosaic / Trowel U4: 2-3 kg/m²
- Medium format / Trowels U6-U8: 3-5 kg/m²
- Large format / Trowels U10-U12: 5-7 kg/m²

*Approximate coverage according to laboratory tests.

Regardless of our recommendations for use indicated for this adhesive, respect the installation regulations in force in each country.

* super-prim improves the adherence on polished ceramics and glossy finishing tiles

Before using this product in any application not indicated in this catalogue, please perform a test or refer to the product's technical sheet.

fr-one n

| SAP | | Presentation | Europallet | P/EU |
|-----------|-----------------|--------------|----------------|-----------|
| 100004241 | fr-one n blanco | bag 25 kg | 1000 kg/pallet | 1.14 p/kg |
| 100004244 | fr-one n gris | bag 25 kg | 1000 kg/pallet | 1.08 p/kg |
| 100277878 | r-eco | bag 250 gr | | 1.31 p/u |

maxifluid

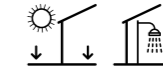

maxifluid is a type C2ES1 high-performance cement-based adhesive, as per EN 12004, for laying all kinds of ceramic tiles on floors. Its high wettability and fluidity ensure full coverage of the underside of tiles without having to resort to the floating and buttering method .

A high-performance fluid, flexible adhesive for laying void-free ceramic floors. Specially recommended for porcelain floor tiles, terracotta and large formats. Indoors and outdoors.



Certifications/Standards:

EN 12004 C2ES1
 CSTB: 2456-222 MC 298 C2-S1-EG



Features:

- Cement-based, single component adhesive.
- A fluid mortar, applicable with a notched trowel, that under the tile pressure, flows and covers the whole back of the tile.
- Excellent adherence.
- Flexible.
- Extended working times. Open time higher than 30 min.
- Application thickness up to 10 mm.
- Frost-resistant.
- Mixing water: 5.0 - 5.5 l per 25 kg bag

Recommended uses:

- Indoor and outdoor porcelain floor tiles
- Large format porcelain floor tiles
- High traffic floor tiles
- Floor tiles with radiant heating
- Laying of tiles on existing glazed floor tiles
- Never use for wall tiles

Substrates:

- Cement-based screeds
- Concrete slabs and floors
- Anhydrite screeds, having previously applied **uniprim**
- Pre-existing tiles/mosaic/stones*
- Mixed with **unilax**, acoustic insulation **fonopac r**

Materials:

- Large format ceramic tiles
- High-absorption ceramic tiles and stoneware
- Porcelain tiles
- Clay and terracotta tiles
- Natural stone and marble not prone to staining

Coverage:

- Small format and mosaic / Trowels U6-U8: 4-6 kg/m²
- Medium format / Trowels U10-U12: 6-8 kg/m²
- Large format / Trowel U10: 6-8 kg/m²

*Approximate coverage according to laboratory tests.

Regardless of our recommendations for use indicated for this adhesive, respect the installation regulations in force in each country.

* super-prim improves the adherence on polished ceramics and glossy finishing tiles

Before using this product in any application not indicated in this catalogue, please perform a test or refer to the product's technical sheet.

maxifluid

| SAP | | Presentation | Europallet | P/EU |
|-----------|----------------|--------------|----------------|-----------|
| 100033113 | maxifluid gris | bag 25 kg | 1000 kg/pallet | 1.09 p/kg |
| 100277878 | r-eco | bag 250 gr | | 1.31 p/u |

one-flex Premium

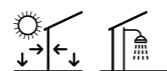

one-flex Premium is a type C2TES1 high-performance cement-based adhesive, as per EN 12004, for laying all kinds of ceramic tiles on the most used substrates in the building.

Very easy to use, one-flex premium can be prepared with a wide range of mixing water giving different properties to the adhesive: high wettability for large floor tiles or an excellent consistency for bedding thickness up to 15mm. Professional use.



Certifications/Standards:

EN 12004 C2TES1
CSTB : 3110-243 MC 574 C2-S1-E



Features:

- Excellent adherence. Flexible.
- Bonding material, with excellent mixing and application features.
- High initial adherence and no sagging. Thixotropic.
- Extended working times. Open time higher than 30 min.
- Application thickness from 2 to 15 mm.
- Broad spectrum in the percentage of mixing water:
one-flex premium white
Mixing water: 8.1 - 8.9 L per 25 kg bag
one-flex premium grey
Mixing water: 6.5 - 7.2 L per 25 kg bag

Substrates:

- Cement-based screeds
- Cement render
- Concrete slabs and floors
- Anhydrite screeds, having previously applied **uniprim**
- Plasters, having previously applied **uniprim**
- Large-format ceramic brick
- Pre-existing tiles/mosaic/stones*
- Plasterboard panels
- Cement-based panels
- Mixed with **unilax**, acoustic insulation **fonopac r**

Recommended uses:

- Floors and walls with rectified tiles
- Large format indoor porcelain wall tiles
- Large format interior porcelain floor tiles and outdoor use
- High traffic floor tiles
- Floor tiles on radiant heating
- Pools and damp environments
- On bonded facades and pools, replace mixing water with **unilax** additive

Materials:

- Large format ceramic tiles
- High-absorption ceramic tiles and stoneware
- Porcelain tiles
- Glass mosaic
- Natural stone and marble not prone to staining

Coverage:

- Small format and mosaic / Trowel U4: 2-3 kg/m²
- Medium format / Trowels U6-U8: 3-5 kg/m²
- Large format / Trowels U10-U12: 5-7 kg/m²

*Approximate coverage according to laboratory tests.

Regardless of our recommendations for use indicated for this adhesive, respect the installation regulations in force in each country.

* super-prim improves the adherence on polished ceramics and glossy finishing tiles

Before using this product in any application not indicated in this catalogue, please perform a test or refer to the product's technical sheet.

one-flex Premium

| SAP | | Presentation | Europallet | P/EU |
|-----------|-------------------------|--------------|----------------|-----------|
| 100201526 | one-flex Premium blanco | bag 25 kg | 1000 kg/pallet | 1.48 p/kg |
| 100201543 | one-flex Premium gris | bag 25 kg | 1000 kg/pallet | 1.42 p/kg |
| 100277878 | r-eco | bag 250 gr | | 1.31 p/u |

super-one n

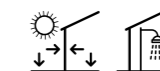

super-one n is a type C2FTS1 high-performance cement-based adhesive, as per EN 12004, ready for traffic after 4 hours. Specially recommended for quick installation and use of ceramic tiles and natural stone.

It solves the need of quick installation of any kind of format and ceramic tile, including porcelain tiles. Ready for traffic in just 4 hours, this adhesive can be used to lay ceramic tiles and natural stone in environments where high mechanical performance is needed, such as commercial or industrial flooring or flooring with radiant heating. Waterproof and frost-resistant.



Certifications/Standards:

EN 12004 C2FTS1
CSTB: 2455-252 MC 312 C2-S1-F



Features:

- Cement-based, single component adhesive.
- Ready for traffic in just 4 hours.
- Excellent adherence. Flexible.
- Fine texture mortar, with excellent mixing and application features.
- High initial adherence and no sagging.
- Extended working times. Open time higher than 30 min.
- Application thickness up to 10 mm.
- Frost-resistant.
- Mixing water: 6.0 - 6.50 l per 25 kg bag

Substrates:

- Cement-based screeds
- Cement render
- Concrete slabs and floors
- Anhydrite screeds, having previously applied **uniprim**
- Plasters, having previously applied **uniprim**
- Pre-existing tiles/mosaic/stones*
- Plasterboard panels
- Cement-based panels
- Mixed with **unilax**, acoustic insulation **fonopac r**

Coverage:

- Small format and mosaic / Trowel U4: 2-3 kg/m²
- Medium format / Trowels U6-U8: 3-5 kg/m²
- Large format / Trowels U10-U12: 5-7 kg/m²

*Approximate coverage according to laboratory tests.

Regardless of our recommendations for use indicated for this adhesive, respect the installation regulations in force in each country.

* super-prim improves the adherence on polished ceramics and glossy finishing tiles

** For slate or similar please contact the Butech technical department

Before using this product in any application not indicated in this catalogue, please perform a test or refer to the product's technical sheet.

super-one n

| SAP | | Presentation | Europallet | P/EU |
|-----------|--------------------|--------------|----------------|-----------|
| 100031188 | super-one n blanco | bag 25 kg | 1000 kg/pallet | 1.90 p/kg |
| 100031189 | super-one n gris | bag 25 kg | 1000 kg/pallet | 1.32 p/kg |
| 100277878 | r-eco | bag 250 gr | | 1.31 p/u |

CEMENT-BASED ADHESIVES

super-flex S2

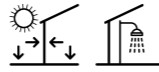

super-flex S2 is a type C2ES2 high-performance no dust cement-based adhesive, as per EN 12004, for laying all kinds of ceramic tiles on the most used substrates in the building industry. Specially recommended for laying large format, thin porcelain tiles like XTONE and XLIGHT.

This adhesive features excellent performance in adherence and deformability with no need for mixing with additives and excellent conditions of use: low dust generation and an only 15 kg package. This state-of-the-art adhesive includes additives and polymers which increase performance. This means that with a 15 kg bag of super-flex S2 you can lay the same tiles surface than with a 25 kg bag of regular adhesive.



Certifications/Standards:
EN 12004 C2ES2

Features:

- Cement-based, single component adhesive.
- Lightened adhesive. Low consumption onsite.
- Low emission of dust and other airborne particles.
- Maximum adherence and deformability.
- High initial adherence and no sagging. Thixotropic.
- Extended working times. Open time higher than 30 min.
- Application thickness up to 10 mm.
- Frost-resistant.
- Mixing water: 6 l per 15 kg bag

Recommended uses:

- Interior walls with slim tiles as XTONE and XLIGHT
- Floors and walls with XTONE and XLIGHT
- Large format indoor and outdoor ceramic wall tiles
- Large format indoor and outdoor porcelain floor tiles
- High traffic floor tiles
- Floor tiles on radiant heating
- Pools and damp environments

Substrates:

- Cement-based screeds
- Cement render
- Concrete slabs and floors
- Anhydrite screeds, having previously applied uniprim
- Plasters, having previously applied **uniprim**
- Pre-existing tiles/mosaic/stones*
- Plasterboard panels
- Cement-based panels
- acoustic insulation **fonopac r**

Materials:

- Large format ceramic tiles
- High-absorption ceramic tiles and stoneware
- Porcelain tiles
- XTONE and XLIGHT
- Glass mosaic
- Natural stone and marble not prone to staining
- DQS and other marble agglomerate

Coverage:

- Small format and mosaic / Trowel U4: 2 kg/m²
- Medium format / Trowels U6-U8: 2-4 kg/m²
- Large format / Trowels U10-U12: 4-6 kg/m²

*Approximate coverage according to laboratory tests.

Regardless of our recommendations for use indicated for this adhesive, respect the installation regulations in force in each country.

* super-prim improves the adherence on polished ceramics and glossy finishing tiles

Before using this product in any application not indicated in this catalogue, please perform a test or refer to the product's technical sheet.

super-flex S2

| SAP | | Presentation | Europallet | P/EU |
|-----------|----------------------|--------------|---------------|-----------|
| 100142757 | super-flex S2 blanco | bag 15 kg | 600 kg/pallet | 3.81 p/kg |
| 100277878 | r-eco | bag 250 gr | | 1.31 p/u |

r eco

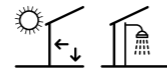

r eco is the first additive for cement-based adhesives that includes recycled plastic in its composition. Developed from fine PET flakes, it is incorporated into the mix of Butech's cement-based adhesives, participating in the reduction of plastic contamination without affecting the performance of the bonding material. Indoor use.

r eco includes 250 gr. 100% recycled plastic, recommended quantity for each 25 kg bag of adhesive, and equivalent to 50 grocery bags. With a simple gesture, if this additive were used in the laying of all the ceramics produced by PORCELANOSA, around 1,000 Tm of plastic would be recycled, reducing waste and improving the state of our planet.

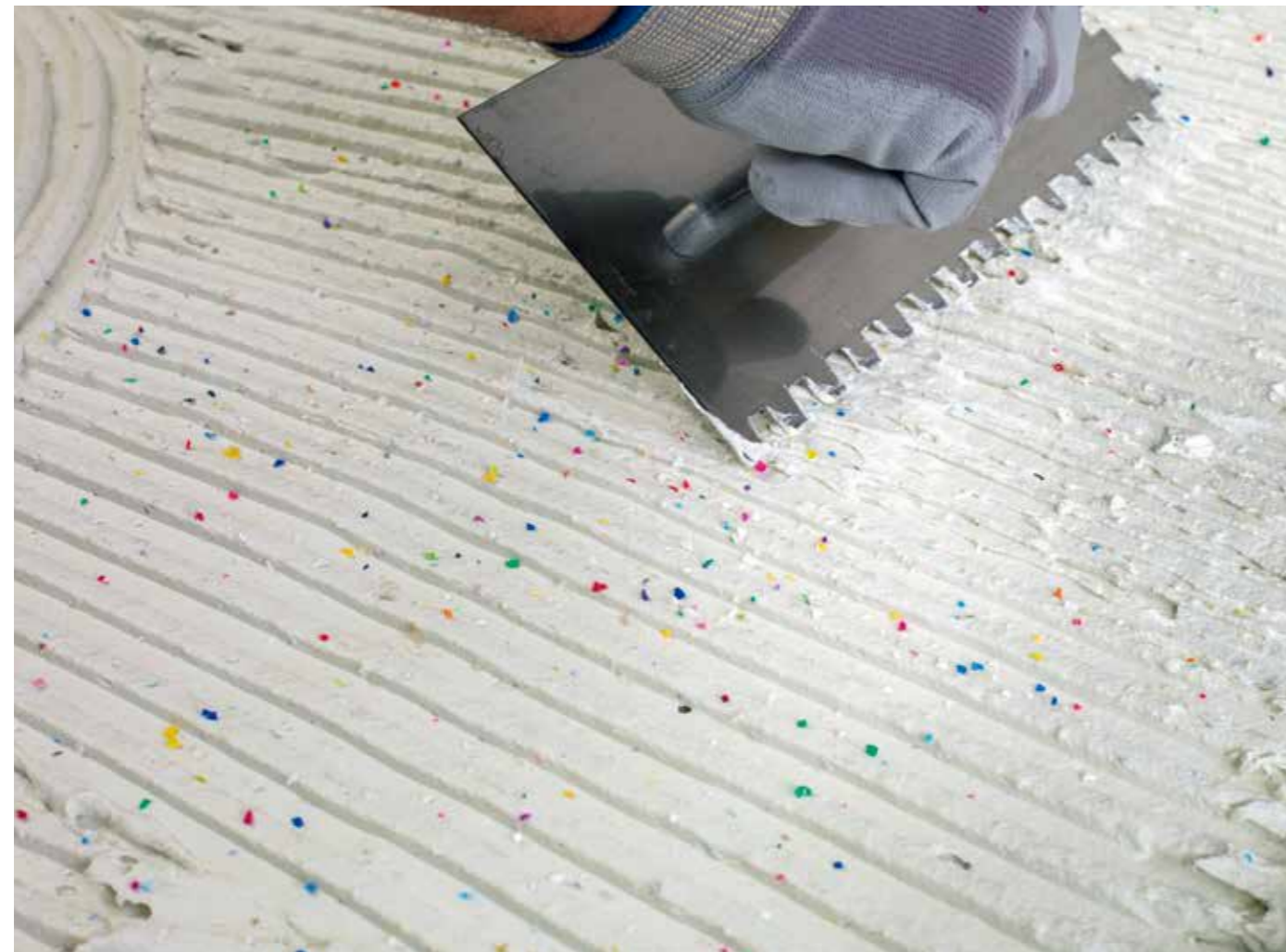

Features:

- Manufactured from PET bottles
- Origin: Post-consumption collected and treated in EC
- Particle size: < 0.2 mm
- Density: 0,575 gr/cm³
- Compatible with Butech's C2 type adhesives
- Percentage in mix: 250 gr of r-eco per 25 kg bag
- Indoor use

Compatible with the following adhesives:

- tioxcem plus
- flexitec n
- fr-one n
- maxifluid
- one-flex Premium
- super-one n

unilax

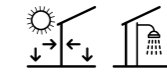

unilax is a latex that, mixed with cement-based adhesives like one-flex Premium, fr-one n or super one n, rapimax n or maxifluid improves bonding strength and flexibility up to level C2S2 as per EN 12004. Specially recommended for laying wall tiles outdoors.

A resin-based latex that can be added to cement-based adhesives to enhance their bonding strength and flexibility. Specially recommended for exterior facades.



Features:

- Water-based acrylic resins latex.
- Resistant to the most common chemicals.
- Excellent resistance to heat.
- Frost-resistant.

Recommended uses:

- Laying of tiles in facades.
- Large format ceramic floor tiles on radiant heating.
- Indoor large format ceramic tile coverings on slightly deformable substrates.
- Indoor and outdoor porcelain tile coverings.
- High traffic floor tiles.
- Pools and damp environments.

Substrates:

- Cement-based screeds
- Cement render
- Concrete slabs and floors
- Anhydrite screeds, having previously applied uniprim
- Plasters, having previously applied **uniprim**
- Pre-existing tiles/mosaic/stones*
- Plasterboard panels
- Cement-based panels

Materials:

- Large format ceramic tiles
- High-absorption ceramic tiles and stoneware
- Porcelain tiles
- Glass mosaic
- Natural stone and marble not prone to staining
- Natural stone and marble prone to staining
- DQS and other marble agglomerate

Coverage:

- For each cementitious adhesive, replace the water in the mixing with the same amount of **unilax**.

*super-prim improves the adherence on polished ceramics and glossy finishing tiles

Before using this product in any application not indicated in this catalogue, please perform a test or refer to the product's technical sheet.

r eco

| | | | |
|------------|-------|---------------------|-------------|
| SAP | | Presentation | P/EU |
| 100277878 | r-eco | bag 250 gr | 1.31 p/u |

unilax

| | | | | |
|------------|--------|---------------------|-------------------|-------------|
| SAP | | Presentation | Europallet | P/EU |
| 100004376 | unilax | can 20 kg | 560 kg/pallet | 6.88 p/kg |
| 100004377 | unilax | can 5 kg | 480 kg/pallet | 7.35 p/kg |

politech n

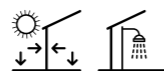

politech n is a type R2T high-tech, two-component polyurethane adhesive as per EN 12004, for laying tiles on deformable substrates. Specially recommended for special substrates like metal sheets or synthetic materials, where cement-based adhesives cannot be used.

A high-tech two-component polyurethane adhesive with high performance properties. Suitable for laying ceramic tiles of all kinds on deformable substrates.



Certifications/Standards:

EN 12004 R2T

Features:

- Two-component polyurethane adhesive.
- Excellent adherence. Maximum deformability.
- No water absorption. Waterproof.
- High chemical resistance.
- High initial adherence and no sagging.
- Application thickness up to 8 mm.
- Frost-resistant.

Recommended uses:

- Laying of wall tiles not compatible with cement-based adhesives
- Wall tiles on substrates not compatible with cement-based adhesives
- Floor tiles on deformable substrates
- Floor tiles with special chemical resistance
- Pools and damp environments, steam rooms and spas
- Laying of slate and other natural stones with risk of deformation by water absorption.
- Interior floors as DQS by L'ANTIC COLONIAL and other marble composites
- KRION sheets

Substrates:

- Cement-based screeds
- Cement render
- Concrete slabs and floors
- Anhydrite screeds
- Renders and plasterboards
- Pre-existing tiles/mosaic/stones*
- Plasterboard panels
- Cement-based panels
- Wood panels
- Metal surfaces
- Polyester or PVC surfaces
- Glass surfaces

Materials:

- Large format ceramic tiles
- High-absorption ceramic tiles and stoneware
- Porcelain tiles
- XTONE and XLIGHT
- Glass mosaic
- Natural stone and marble not prone to staining
- Natural stone and marble prone to staining
- Slates and similar sensitive to contact with water
- DQS and other marble agglomerate
- KRION and other kinds of solid surface

Coverage:

- Small format and mosaic / Trowel U3: 2 kg/m²
- Medium format / Trowels U4: 2-3 kg/m²
- Large format / Trowels U6: 3-4 kg/m²

*Approximate coverage according to laboratory tests.

Regardless of our recommendations for use indicated for this adhesive, respect the installation regulations in force in each country.

Before using this product in any application not indicated in this catalogue, please perform a test or refer to the product's technical sheet.

politech n

| SAP | Presentation | Europallet | P/EU |
|-----------|-----------------------------|---------------|------------|
| 100138260 | politech n blanco can 12 kg | 576 kg/pallet | 11.95 p/kg |

politech Premium

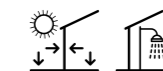

politech Premium is a reactive resin adhesive that is super easy to handle and easy to use, especially when we need maximum bonding strength and deformability. It is suitable for most wall coverings and substrates used in construction, ensuring the correct installation of materials such as L'ANTIC COLONIAL's AIRSLATE.

We work with it as a cement-based adhesive, but with the bonding, flexibility, and water resistance capabilities of a reactive resin adhesive. Professional use.



Certifications/Standards:

EN 12004 R2T

Features:

- Two-component reactive resins adhesives.
- Unbeatable workability; same as that of any cement-based adhesive.
- Maximum adherence and excellent flexibility; more than 50 mm in transversal deformability.
- High wettability and long open time.
- Quick-drying: admits light traffic 6 hours after installation.
- Application thickness up to 15 mm.

Recommended use:

- Laying of wall tiles not compatible with cement-based adhesives
- Wall tiles on substrates not compatible with cement-based adhesives
- Floor tiles on deformable substrates
- Floor tiles with special chemical resistance
- Pools and damp environments, steam rooms and spas
- Stone sheets for wall coverings as AIRSLATE by L'ANTIC COLONIAL
- Laying of slate and other natural stones with risk of deformation by water absorption.

Substrates:

- Substrates in concrete and cement or anhydrite mortar.
- Slabs and cement mortar or gypsum rendering.
- Plasterboard and wood panels.
- Existing wall tiles.
- Metal sheets.
- Surfaces painted with epoxy or polyurethane-based resins.

Materials:

- Large format ceramic tiles
- High-absorption ceramic tiles and stoneware
- Porcelain tiles
- XTONE and XLIGHT
- Glass mosaic
- Natural stone and marble not prone to staining
- Natural stone and marble prone to staining
- Slates and similar sensitive to contact with water
- AIRSLATE
- DQS and other marble agglomerate

Coverage:

- Small format and mosaic / Trowel U3: 2 kg/m²
- Medium format / Trowels U4: 2-3 kg/m²
- Large format / Trowels U6: 3-4 kg/m²

*Approximate coverage according to laboratory tests.

Regardless of our recommendations for use indicated for this adhesive, respect the installation regulations in force in each country.

Before using this product in any application not indicated in this catalogue, please perform a test or refer to the product's technical sheet.

politech Premium

| SAP | Presentation | Europallet | P/EU |
|-----------|----------------------------|---------------|------------|
| 100217753 | politech Premium can 10 kg | 330 kg/pallet | 17.56 p/kg |

linkfloor fix

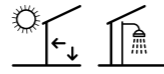

linkfloor fix is a solvent-free acrylic adhesive for lightweight floor coverings such as carpets, PVC, rubber or linoleum sheets, even on heavily trafficked floors. Its high performance and great versatility allow it to be used in all types of technical installations like sports venues, including walls. Professional use.

Especially recommended for installing Linkfloor floors from L'ANTIC COLONIAL.



Certifications / Standards:

IMO nautical certification

Features:

- Solvent- and odor-free adhesive
- Excellent adhesion and flexibility
- High initial grip, especially for wall applications
- Resistant to high traffic such as hospitals or airports
- Compatible with underfloor heating
- Suitable for the installation of new PVC sheets on existing PVC flooring

Recommended use:

- Non ceramic, indoor floor and wall coverings
- High traffic floor coverings.
- Floor coverings on radiant heating.

Substrates:

- Cement covered floors and walls.
- Concrete slabs.
- Plasterboards.
- Existing ceramic floor and wall coverings.
- Existing parquet floors.
- Existing PVC floors.
- On fire-resistant or water-resistant wood panels, apply super-prim

Materials:

- Decorative PVC Tiles (LVT).
- Homogeneous and multi-layer PVC (tiles or rolls).
- PVC on cork.
- Polyolefins.
- Linoleum in rolls.
- Expanded vinyls with relief.
- Semiflexible tiles.
- Carpets with or without backing.
- Carpets on foam (latex).
- Carpets with non-woven backing.
- Carpets with synthetic back (Action Back).
- Especially indicated for Linkfloor from L'ANTIC COLONIAL

Coverage:

- Wall tiles with smooth and non-embossed backs 200 – 250 gr/m²
- Wall tiles with rough backs 300 – 350 gr/m²

*Approximate coverage according to laboratory tests.

Regardless of our recommendations for use indicated for this adhesive, respect the installation regulations in force in each country.

Before using this product in any application not indicated in this catalog, please perform a test or refer to the product's technical sheet.

linkfloor fix

| SAP | | Presentation | Europallet | P/EU |
|-----------|---------------|--------------|---------------|------------|
| 100243761 | linkfloor fix | can 20 kg | 640 kg/pallet | 12.02 p/kg |

skins fix



skins fix is a coloured adhesive for the installation of all types of wallpapers: non-woven fabric (TNT), vinyl, duplex, light, heavy and other wallpapers. The colour indicator marks the area where the glue has been applied, facilitating the application of the wallpaper.

Especially developed for the installation of SKINS WALLPAPER from L'Antic Colonial.



Features:

- Ready-to-use adhesive
- Pink colour during application, transparent once dry

Recommended use:

- Interior walls with all kinds of wallpapers
- Suitable for environments with the presence of humidity such as kitchens and bathrooms
- Applicable on furniture and doors
- Suitable for all types of wallpapers: light, heavy, vinyl, woven or duplex
- Laying of slate and other natural stones with risk of deformation by water absorption

Substrates:

- Supports suitable for wallpaper, sound, dry, clean, solid, smooth and absorbent

Materials:

- Suitable for all types of wallpapers: light, heavy, vinyl, woven or duplex

Coverage:

- Approximately 125 gr/m²

*Approximate coverage according to laboratory tests.

Regardless of our recommendations for use indicated for this adhesive, respect the installation regulations in force in each country.

Before using this product in any application not indicated in this catalogue, please perform a test or refer to the product's technical sheet.

skins fix

| SAP | | Presentation | P/EU |
|-----------|-----------|--------------|-----------|
| 100309616 | skins fix | can 3 kg | 22.32 p/u |

h-920

h-920 is a high-performance hybrid polymer adhesive and sealant. It polymerizes in contact with environmental humidity, becoming an elastomer with extraordinary elasticity and excellent adhesion. Free of isocyanates, silicones and solvents, provides a high grip since its application, on a wide variety of materials used in construction such as ceramic or porcelain tiles, natural stone, wood or metal. Professional use.



Features:

- Hybrid polymer suitable as both adhesive and sealant.
- Maximum flexibility
- High mechanical performance
- Great initial grip; rapid skin formation and final curing.
- Excellent adhesion even on wet surfaces and immersion
- Resistant to UV radiation and atmospheric agents
- Paintable

Recommended applications:

- Interior and exterior coatings
- Direct stick adhesive, immediate hold.
- Elastic bonding in construction on galvanized sheets, ferrous or non-ferrous metals, plastic materials or polystyrene. Especially recommended for:
 - Installation of ventilated facades.
 - Installation of raised access floors
- Bonding Concept XPS panels.
- Sealing of movement joints in walls

Supports:

- All the usual supports for laying tiles

Materiales:

- Ceramic tiles and glass mosaic.
- Brick, concrete, exposed work, marble and natural stone.
- Wood panels.
- Concept XPS and other polystyrene panels.
- Metals such as aluminium, iron, zinc and galvanized.
- PVC and plastic materials.
- KRION and other types of solid surface.

Coverage:

- Approximately 2 m²/cartridge

*Approximate coverage according to laboratory tests.

Regardless of our recommendations for use indicated for this adhesive, respect the installation regulations in force in each country.

Before using this product in any application not indicated in this catalog, please perform a test or refer to the product's technical sheet.

h-920

| SAP | Presentation | Packaging | P/EU |
|-----------|---------------------------------|-----------|-----------|
| 100292915 | h-920 white cartridge 290 ml | 25 ud/box | 11.89 p/u |

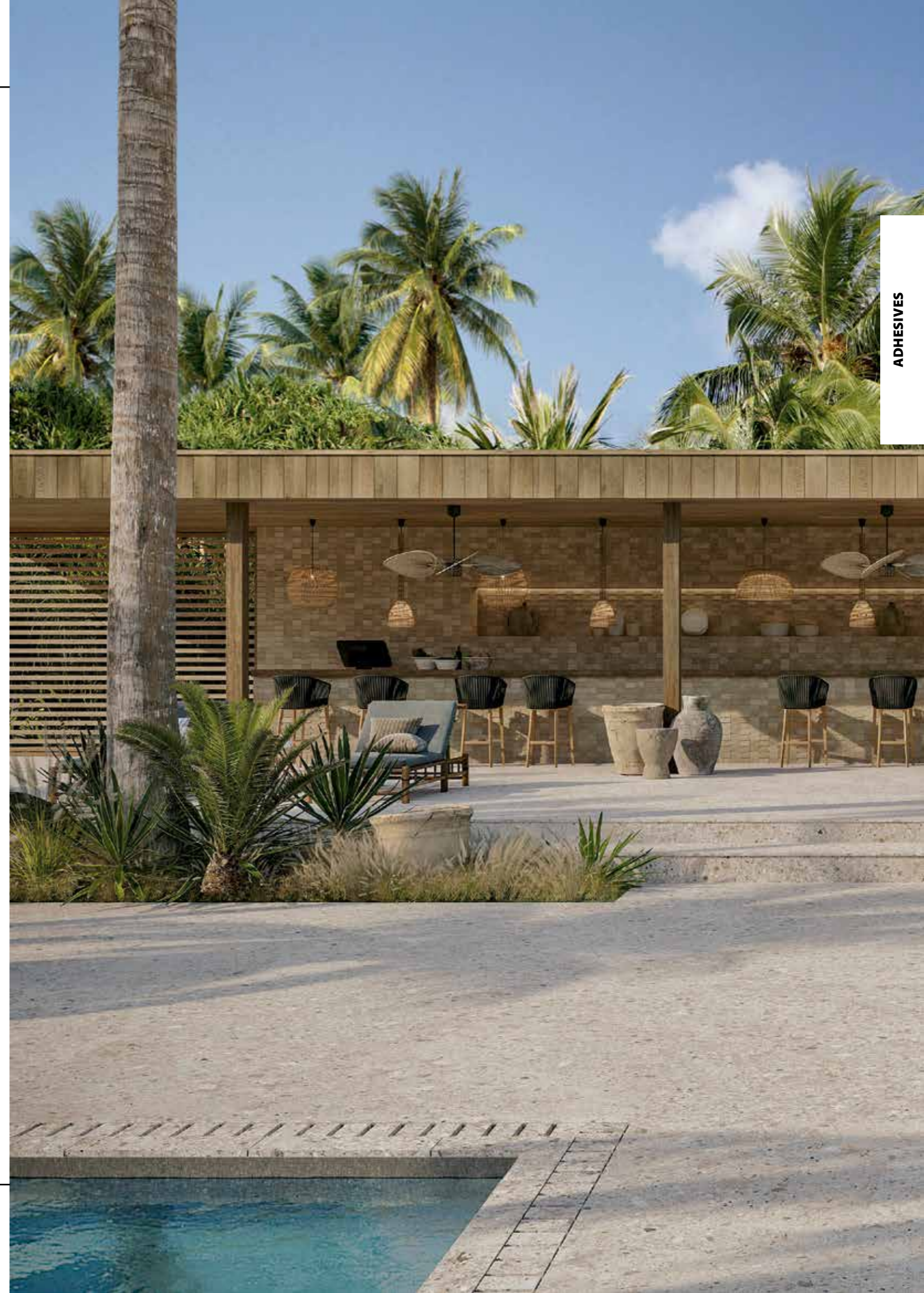

bonded façade clips

These clips have been designed as a security element in bonded façades using porcelain tiles installed by the thin-layer and back-butter method. The use of cementitious adhesives type C2S2 according to EN 12004 is recommended.

Features:

- Stainless Steel clips 1.4301 (AISI 304 V2A)

Aplicaciones recomendadas:

- Installation of tiles on outdoor walls
- Installation of tiles in interiors, ceilings and cornices when a mechanical fixing system is needed

Types of clips:

- Type 1** Middle clip: joints up to 7mm
- Type 2** Perimeter clip: joints up to 7mm.
- Type 5** Clip for staggered pattern: joints up to 7mm.



Coverage:

The number of clips varies with each façade design. In the case of a regular façade without gaps, the approximate number of clips would be

Straight pattern:

| Tile | Clips Type 1 | Clips Type 2 |
|-----------------|--------------|--------------|
| 59,6cm x 59,6cm | 4,5 | 1,1 |
| 59,6cm x 120cm | 2,8 | 0,7 |
| 59,6cm x 180cm | 2,2 | 0,6 |
| 40cm x 80cm | 5,0 | 1,3 |
| 80cm x 80cm | 2,5 | 0,6 |
| 120cm x 120cm | 1,7 | 0,4 |
| 120cm x 250cm | 0,9 | 0,2 |
| 150cm x 300cm | 0,7 | 0,2 |

Staggered pattern:

| Tile | Clips Type 1 | Clips Type 2 | Clips Type 5 |
|----------------|--------------|--------------|--------------|
| 25cm x 150cm | 2,7 | 1,6 | 6,4 |
| 29,4cm x 120cm | 2,8 | 1,7 | 6,8 |

bonded façade clips

Hidden clips

Mechanical fixing system for porcelain tiles, where the clip goes into side grooves. Once the joints have been grouted, the clips become hidden without affecting the design of the façade.

Tiles from 10 to 12 mm thick and joints up to 7 mm

STON-KER, SOLIDKER, PAR-KER y HIGHKER

| SAP | Description | Clip type | Size | Packaging | P/EU |
|-----------|------------------------|-----------|-------------------|------------|----------|
| 100005743 | Middle clip I | Type 1 | 40mm x 20mm x 9mm | 50 pcs bag | 1.53 p/u |
| 100005744 | Middle clip A/T 4cm | Type 2 | 40mm x 20mm x 9mm | 50 pcs bag | 1.53 p/u |
| 100005745 | Middle clip A/T 8cm | Type 2 | 80mm x 20mm x 9mm | 50 pcs bag | 1.70 p/u |
| 100315264 | Staggered pattern clip | Type 5 | 40mm x 20mm x 9mm | 50 pcs bag | 1.97 p/u |

* Includes stainless steel screw and plug for ceramic brick or concrete

Exposed clips

Clip for bonded façades where its fastening tabs are visible after the installation of the porcelain tile. Made of stainless steel, they can be supplied lacquered in the colour that best matches the chosen tile.

Tiles from 10 to 12 mm thick and joints up to 7 mm

STON-KER, SOLIDKER, PAR-KER y HIGHKER

| SAP | Description | Clip type | Size | Packaging | P/EU |
|-----------|---------------------|-----------|--------------------|------------|----------|
| 100110368 | Middle clip I | Type 1 | 40mm x 20mm x 16mm | 50 pcs bag | 1.70 p/u |
| 100110369 | Middle clip A/T 4cm | Type 2 | 40mm x 20mm x 16mm | 50 pcs bag | 1.70 p/u |

* Ask the butech sales team about the availability of lacquered finishes matching the tile chosen

** Plug and stainless steel screw not included

8.5 mm thick tiles and joints up to 7 mm

STON-KER L

| SAP | Description | Clip type | Size | Packaging | P/EU |
|-----------|---------------------|-----------|--------------------|------------|----------|
| 100315272 | Middle clip I | Type 1 | 40mm x 20mm x 13mm | 50 pcs bag | 1.60 p/u |
| 100315290 | Middle clip A/T 4cm | Type 2 | 40mm x 20mm x 13mm | 50 pcs bag | 1.60 p/u |

* Ask the butech sales team about the availability of lacquered finishes matching the tile chosen

** Plug and stainless steel screw not included

6 mm thick tiles and joints up to 7 mm

XTONE

| SAP | Description | Clip type | Size | Packaging | P/EU |
|-----------|---------------------|-----------|----------------------|------------|----------|
| 100315292 | Middle clip I | Type 1 | 40mm x 20mm x 10.5mm | 50 pcs bag | 1.50 p/u |
| 100315265 | Middle clip A/T 4cm | Type 2 | 40mm x 20mm x 10.5mm | 50 pcs bag | 1.50 p/u |

* Ask the butech sales team about the availability of lacquered finishes matching the tile chosen

** Includes stainless steel screw and plug for ceramic brick or concrete

Selection tables for butech's adhesives

SELECTION OF ADHESIVE FOR RESIDENTIAL INDOOR FLOORING AND PUBLIC PEDESTRIAN PREMISES

Types of tiles (ISO 13006): BI_a / BI_b

Rectified tiles, Porcelain tiles, STON-KER, PAR-KER

| Type of substrate | Length longest side of tile | | | |
|---|-----------------------------|---------|---------|---------|
| | ≤ 300mm | ≤ 600mm | ≤ 900mm | > 900mm |
| Cement-based screed with radiant heating | C2 | C2 S1 | | C2 S2 |
| Cement-based screed without radiant heating | C1 | C2 | | |
| Anhydrite screed with radiant heating* | C2 | C2 S1 | | C2 S2 |
| Anhydrite screed without radiant heating* | C1 | C2 | | |
| Concrete slab or floor | C2 | | C2 S1 | |
| Pre-existing tiles/mosaic/stones | C2 | | | |
| Metal surfaces | R1 | | - | |

* previous priming with C adhesives

SELECTION OF ADHESIVE FOR COMMERCIAL INDOOR FLOORING OR FOR INDUSTRIAL USE WITH MECHANICAL REQUIREMENTS

Types of tiles (ISO 13006): BI_a / BI_b

Rectified tiles, Porcelain tiles, STON-KER, PAR-KER

| Type of substrate | Length longest side of tile | | | |
|---|-----------------------------|---------|---------|---------|
| | ≤ 300mm | ≤ 600mm | ≤ 900mm | > 900mm |
| Cement-based screed with radiant heating | C2 | C2 S1 | | C2 S2 |
| Cement-based screed without radiant heating | C2 | | C2 S1 | |
| Concrete slab or floor | C2 | | C2 S1 | |
| Pre-existing tiles/mosaic/stones | C2 | | C2 S1 | |
| Metal surfaces | R1 | | R2 | - |

SELECTION OF ADHESIVE FOR OUTDOOR FLOORING

Types of tiles (ISO 13006): BI_a

Rectified tiles, Porcelain tiles, STON-KER, PAR-KER

| Type of substrate | Length longest side of tile | | | |
|---|-----------------------------|---------|---------|---------|
| | ≤ 300mm | ≤ 600mm | ≤ 900mm | > 900mm |
| Cement-based screed without radiant heating | C2 | C2 S1 | C2 S2 | |
| Concrete slab or floor | C2 | C2 S1 | C2 S2 | |
| Pre-existing tiles/mosaic/stones | C2 S1 | C2 S1 | C2 S2 | |
| Metal surfaces | R1 | | R2 | - |

SELECTION OF ADHESIVE FOR INDOOR WALLS

Types of tiles (ISO 13006): BI_a

Porcelain tiles, STON-KER, PAR-KER

| Type of substrate | Length longest side of tile | | | |
|---|-----------------------------|------------|---------|---------|
| | ≤ 300mm | ≤ 600mm | ≤ 900mm | > 900mm |
| Lime/cement-based plaster with radiant heating | C2 / D1 | C2 S1 | | C2 S2 |
| Lime/cement-based plaster without radiant heating | C1 / D1 | C2 | | |
| Gypsum-based plaster with radiant heating* | C2 / D1 | C2 S1 | | C2 S2 |
| Gypsum-based plaster without radiant heating* | C1 / D1 | C2 | | |
| Large-format ceramic brick | C1 | C2 | | |
| Concrete | C2 / D1 | C2 | C2 S1 | |
| Pre-existing tiles/mosaic/stones | C2 | | C2 S1 | |
| Cement/fiber cement -based panels | C1 / D1 | C2 | | C2 S1 |
| Wood surfaces | C2 / D1 / R1 | C2 S1 / R1 | | - |
| Plasterboard panels | C1 / D1 | C2 | C2 S1 | - |
| Metal surfaces | R1 | | - | |

* previous priming with C adhesives

Types of tiles (ISO 13006): BIII

Wall tiles, Rectified wall tiles

| Type of substrate | Length longest side of tile | | | |
|---|-----------------------------|------------|---------|---------|
| | ≤ 300mm | ≤ 600mm | ≤ 900mm | > 900mm |
| Lime/cement-based plaster with radiant heating | C2 / D1 | C2 S1 | | C2 S2 |
| Lime/cement-based plaster without radiant heating | C1 / D1 | C1 | C2 | |
| Gypsum-based plaster with radiant heating* | C2 / D1 | C2 S1 | | C2 S2 |
| Gypsum-based plaster without radiant heating* | C1 / D1 | C1 | C2 | |
| Large-format ceramic brick | C1 | C1 | C2 | |
| Concrete | C1 | C2 | C2 S1 | |
| Pre-existing tiles/mosaic/stones | C2 | | C2 S1 | |
| Cement/fiber cement -based panels | C1 / D1 | C2 | | C2 S1 |
| Wood surfaces | C2 / D1 / R1 | C2 S1 / R1 | | - |
| Plasterboard panels | C1 / D1 | C2 | C2 S1 | - |
| Metal surfaces | R1 | | - | |

* previous priming with C adhesives

SELECTION OF ADHESIVE FOR OUTDOOR WALLS AND CEILINGS

Types of tiles (ISO 13006): BI_a / BIII

Wall tiles, Rectified wall tiles, Porcelain tiles, STON-KER, PAR-KER

| Type of substrate | Length longest side of tile | | | |
|-----------------------------------|-----------------------------|---------|---------|---------|
| | ≤ 300mm | ≤ 600mm | ≤ 900mm | > 900mm |
| Lime/cement-based plaster | C2 S1 | C2 S1 | C2 S2 | |
| Concrete | C2 S1 | C2 S2 | | |
| Cement/fiber cement -based panels | C2 S1 | C2 S2 | | - |
| Metal surfaces | R1 | | R2 | - |

Selection tables for butech's adhesives

SELECTION OF ADHESIVE FOR WALL COVERINGS AND FLOORING WITH CERAMIC PLATES

Types of tiles (ISO 13006): Bla

XTONE & XTONE Premium

| Type of substrate | No fiber | | With fiber | |
|------------------------------|----------|---------|------------|---------|
| | ≤ 70 cm | > 70 cm | ≤ 70 cm | > 70 cm |
| Indoor flooring and wall | C2 | C2 S1 | C2 S1 | C2 S2 |
| Outdoor or heated flooring | C2 S2 | | | |
| Facade | C2 S1 | C2 S2 | R2 | |
| Highly deformable substrates | R2 | | | |

SELECTION OF ADHESIVE FOR FLOORING AND WALL COVERINGS WITH MOSAICS

| Type of substrate | No mesh | | | With mesh | | |
|--|---------------------|---------------|--------------|---------------------|---------------|--------------|
| | Vitreous & ceramics | Natural stone | Wood & metal | Vitreous & ceramics | Natural stone | Wood & metal |
| Indoor flooring and wall without presence of water | C2 | C2 S1 F | R2 | C2 S1 | C2 S1 F | R2 |
| Indoor flooring and wall with presence of water | C2 S1 | C2 S1 F | R2 | C2 S1 | C2 S1 F | R2 |
| Pools | C2 S2 | C2 S2 | - | - | - | - |
| Highly deformable substrates | R2 | | | R2 | | |

SELECTION OF ADHESIVE FOR FLOORING AND WALL COVERINGS WITH NATURAL STONE

| Type of substrate | Stain resistant | | Sensitive to stains | | Slate and similar | | DQS** |
|--|-----------------|---------|---------------------|---------|-------------------|---------|---------|
| | ≤ 600mm | > 600mm | ≤ 600mm | > 600mm | ≤ 300mm | > 300mm | |
| Indoor flooring and wall without presence of water | C2 | C2 S1 | C2 F | C2 S1 F | C2 S1 F | R2 | C2 S2 F |
| Indoor flooring and wall with presence of water | C2 S1 | C2 S2 | C2 S1 F | C2 S2 F | C2 S2 F | R2 | - |
| Outdoor or heated flooring | C2 S2 | C2 S2 | C2 S2 F | C2 S2 F | C2 S2 F | R2 | - |
| Pools | C2 S2 | C2 S2 | C2 S2 F | C2 S2 F | C2 S2 F | R2 | - |
| Highly deformable substrates | R2 | | | | | | |

* Meshed natural stone plates: Check with butech's Technical Department

** In floors with direct sunlight, use R2 adhesives

Coverage tables for butech's adhesives depending on the notched trowel used

| ADHESIVE COVERAGE (kg / m ²) | U3 | U4 | U6 | U8 | U10 | U12 | Ø10 |
|--|-------|-------|-------|-------|---------|---------|-----------|
| Type of adhesive | 3 x 3 | 4 x 4 | 6 x 6 | 8 x 8 | 10 x 10 | 12 x 12 | R 10 x 10 |
| tixocem plus | | 2-3 | 3-4 | 4-5 | 5-6 | | |
| flexitec n | | 2-3 | 3-4 | 4-5 | 5-6 | | |
| fr-one n | | 2-3 | 3-4 | 4-5 | 5-6 | 6-7 | |
| one-flex premium | | 2-3 | 3-4 | 4-5 | 5-6 | 6-7 | |
| super-one n | | 2-3 | 3-4 | 4-5 | 5-6 | 6-7 | |
| super-flex s2 | | 1-2 | 2-3 | 3-4 | 4-5 | 5-6 | |
| maxifluid | | | | | | 6-7 | 6-7 |
| politech n | 1-2 | 2-3 | 3-4 | 4-5 | | | |
| politech premium | 1-2 | 2-3 | 3-4 | 4-5 | | | |

| RECOMMENDED NOTCHED TROWEL | U3 | U4 | U6 | U8 | U10 | U12 | Ø10 | |
|----------------------------|-------------|-------|-------|-------|-------|---------|---------|-----------|
| Type of ceramics | mm x mm | 3 x 3 | 4 x 4 | 6 x 6 | 8 x 8 | 10 x 10 | 12 x 12 | R 10 x 10 |
| Wall tiles | 316 x 200 | | x | x | | | | |
| Wall tiles | 316 x 446 | | x | x | x | | | |
| Wall tiles | 316 x 592 | | x | x | x | x | | |
| Wall tiles | 316 x 900 | | x | x | x | x | x | |
| Wall tiles | 450 x 1200 | | x | | x | x | x | |
| PAR-KER | 215 x 659 | | x | x | x | x | | |
| PAR-KER | 143 x 900 | | x | | x | x | | |
| PAR-KER | 220 x 900 | | x | | x | x | | |
| PAR-KER | 193 x 1200 | | x | | x | x | x | x |
| PAR-KER | 294 x 1200 | | x | | x | x | x | x |
| PAR-KER | 250 x 1500 | | x | | x | x | x | x |
| PAR-KER | 193 x 1800 | | x | | x | x | x | x |
| PAR-KER | 294 x 1800 | | x | | x | x | x | x |
| STON-KER | 443 x 443 | | x | x | x | x | | |
| STON-KER | 435 x 659 | | x | | x | x | x | x |
| STON-KER | 450 x 900 | | x | | x | x | x | x |
| STON-KER | 596 x 596 | | x | | x | x | x | x |
| STON-KER | 800 x 800 | | x | | x | x | x | x |
| STON-KER | 596 x 1200 | | x | | | x | x | x |
| STON-KER | 1200 x 1200 | | x | | | x | x | x |
| XTONE | 1000 x 3000 | x | x | | x | x | x | |
| XTONE Premium | 1200 x 1200 | x | x | | x | x | x | |
| XTONE Premium | 1200 x 2500 | x | x | | x | x | x | |
| XTONE Premium | 1500 x 3200 | x | x | | x | x | x | |
| MOSAICS | | x | x | x | | | | |
| AIRSLATE | 1200 x 2400 | | x | x | | | | |

x Recommended trowel with standard conditions



GROUTING MATERIAL AND ELASTIC SEALANTS

CEMENT-BASED MATERIALS FOR TILE JOINTS

colorstuk rapid n, **136** | colorstuk 0-4 n, **137** | colorstuk n especial, **138**

ADDITIVES FOR CEMENT-BASED JOINTS

cl-stuk, **139**

EPOXY GROUTING MATERIALS

epotech aqua, **140** | epotech nature, **141** | epotech crystal, **142**
epoxy cleaning kit, **143** | epotech cleaner, **143** | epoxy sponge, **143**

ELASTIC JOINT SEALANTS

s-107 n, **144** | s-502 n, **145** | p-404, **147**

LEVELING SYSTEM FOR CERAMIC TILES

self-leveling spacers, **148**

colorstuk rapid n

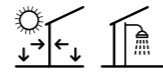

colorstuk rapid n is a type CG2 WA high-performance, cement-based grouting material as per EN 13888, for grouting joints up to 15 mm. Suitable for all kinds of ceramic tiles and natural stone, it is specially recommended for outdoor applications and permanently damp environments .

A high-tech, fine grained colored mortar with fast setting and hardening times for grouting tile joints up to 15 mm. Suitable for all kinds of ceramic tiles and natural stone. Indoors and outdoors.



Certifications/Standards:
EN 13888 CG2 WA

Features:

- Cement-based, single-component, colored mortar.
- Fine texture mortar for grouting tile joints up to 15 mm.
- Mortar with fast setting and hardening times.
- It prevents efflorescences.
- Excellent mechanical resistance.
- Resistant to heat and UV radiation.
- Frost-resistant.
- Waterproof mortar.
- Anti-mold action.
- Easy to apply and clean.
- Wide color range.
- Mixing water: colorstuk rapid n 1-1,3 l per 5 kg bag.

Recommended uses:

- Tile joints up to 15 mm.
- Indoor wall and floor tiles.
- Outdoor floors and terraces.
- High traffic floor tiles.
- Floor tiles on radiant heating.
- Pools and damp environments.
- Outdoor wall tiles in facades.

Substrates:

- All usual substrates for ceramic tiles laying.

Coverage:

- See the grouting materials table on page 150

Materials:

- Absorbent and non-absorbent ceramic tiles, including porcelain tiles.
- Tiles with mosaic-like patterns.
- Glass mosaic.
- Clay and terracotta tiles.
- Natural stone and marble not prone to staining.

| colorstuk rapid n | | | | |
|-------------------|-----------|--------------|---------------|-----------|
| SAP | | Presentation | Europallet | P/EU |
| 100236463 | blanco | bag 5 kg | 400 kg/pallet | 3.67 p/kg |
| 100275760 | perla | bag 5 kg | 400 kg/pallet | 4.56 p/kg |
| 100236834 | gris | bag 5 kg | 400 kg/pallet | 3.76 p/kg |
| 100236808 | beige | bag 5 kg | 400 kg/pallet | 4.50 p/kg |
| 100331788 | caliza | bag 5 kg | 400 kg/pallet | 4.44 p/kg |
| 100309550 | oak | bag 5 kg | 400 kg/pallet | 4.93 p/kg |
| 100236794 | marfil | bag 5 kg | 400 kg/pallet | 4.44 p/kg |
| 100236833 | caramelo | bag 5 kg | 400 kg/pallet | 3.92 p/kg |
| 100236809 | marron | bag 5 kg | 400 kg/pallet | 3.32 p/kg |
| 100236823 | tabaco | bag 5 kg | 400 kg/pallet | 4.82 p/kg |
| 100236824 | moka | bag 5 kg | 400 kg/pallet | 3.43 p/kg |
| 100236464 | manhattan | bag 5 kg | 400 kg/pallet | 3.52 p/kg |
| 100236449 | cemento | bag 5 kg | 400 kg/pallet | 3.06 p/kg |
| 100236481 | antracita | bag 5 kg | 400 kg/pallet | 3.15 p/kg |
| 100236475 | negro | bag 5 kg | 400 kg/pallet | 3.75 p/kg |

The colours shown are approximate and may vary for printing reasons.

Before using this product in any application not indicated in this catalogue, please perform a test or refer to the product's technical sheet.

colorstuk 0-4 n

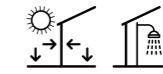

colorstuk 0-4 n is a type CG2 WA fine grain grouting material as per EN 13888, for grouting joints up to 4 mm. It is easy to apply, resistant and color stable, and it is specially recommended for rectified tiles.

A high-tech, fine grained colored mortar for grouting tile joints from 0 to 4 mm. Suitable for all kinds of ceramic tiles and natural stone. Indoors and outdoors.



Certifications/Standards:
EN 13888 CG2 WA

Features:

- Cement-based, single-component, colored mortar.
- Fine texture mortar for grouting tile joints up to 4 mm.
- Easy to apply and clean.
- Resistant to heat and UV radiation.
- Frost-resistant.
- Wide color range.
- Mixing water: colorstuk 0-4 n 1,5 l per 5 kg bag.

Recommended uses:

- Tile joints up to 4 mm.
- Indoor wall tile coverings. Specially recommended for rectified tiles.
- Indoor floor tiles, including public buildings.

In the following applications, replace mixing water by cl-stuk additive:

- Outdoor floors.
- High traffic floor tiles.
- Floor tiles on radiant heating.
- Pools and damp environments.

Substrates:

- All usual substrates for ceramic tiles laying.

Coverage:

- See the grouting materials table on page 150

Materials:

- Absorbent and non-absorbent ceramic tiles, including porcelain tiles.
- Glass mosaic.
- Natural stone and marble not prone to staining.

In the following applications, replace mixing water by cl-stuk additive:

- Wall tiles with mosaic-like patterns.
- DQS slabs and other kinds of marble agglomerate.

| colorstuk 0-4 n | | | | |
|-----------------|-----------|--------------|---------------|-----------|
| SAP | | Presentation | Europallet | P/EU |
| 100236442 | blanco | bag 5 kg | 400 kg/pallet | 1.99 p/kg |
| 100275725 | perla | bag 5 kg | 400 kg/pallet | 2.15 p/kg |
| 100236806 | gris | bag 5 kg | 400 kg/pallet | 2.10 p/kg |
| 100236419 | beige | bag 5 kg | 400 kg/pallet | 2.51 p/kg |
| 100236480 | marfil | bag 5 kg | 400 kg/pallet | 1.90 p/kg |
| 100236446 | marrón | bag 5 kg | 400 kg/pallet | 1.90 p/kg |
| 100236807 | moka | bag 5 kg | 400 kg/pallet | 2.05 p/kg |
| 100236461 | manhattan | bag 5 kg | 400 kg/pallet | 1.90 p/kg |
| 100236462 | cemento | bag 5 kg | 400 kg/pallet | 1.90 p/kg |
| 100236409 | antracita | bag 5 kg | 400 kg/pallet | 1.90 p/kg |
| 100236472 | negro | bag 5 kg | 400 kg/pallet | 2.43 p/kg |

The colours shown are approximate and may vary for printing reasons.

Before using this product in any application not indicated in this catalogue, please perform a test or refer to the product's technical sheet.

colorstuk especial n

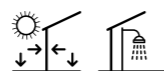

colorstuk especial n is a type CG2 WA very fine grain grouting material as per EN 13888, for grouting joints up to 4 mm. Its formula includes ultrafine aggregates, which make it specially recommended for tiles with a glaze sensitive to scratching.

A high-tech, fine grained colored mortar for grouting tile joints up to 4 mm. Specially recommended for grouting rectified ceramic tiles sensible to scratching, and ceramic parquet flooring



Certifications/Standards:
EN 13888 CG2 WA

Features:

- Cement-based, single-component, colored mortar.
- Ultrafine aggregates formula.
- Fine texture mortar for grouting tile joints up to 4 mm.
- Easy to apply and clean.
- Resistant to heat and UV radiation.
- Frost-resistant.
- Wide special colors range.
- Mixing water:
colorstuk especial n 0,64 l per 2 Kg bag.

Substrates:

- All usual substrates for ceramic tiles laying.

Coverage:

- See the grouting materials table on page 150

Recommended uses:

- Tile joints up to 4 mm.
- Ceramic tiles with low hardness glaze as per Mohs scale.
- Indoor wall tile coverings. Specially recommended for rectified tiles.
- Indoor floor tiles, including public buildings.

In the following applications, replace mixing water with **cl-stuk** additive:

- Wall and floor tiles into direct contact with water.
- Floor tiles on radiant heating.

Materials:

- Absorbent and non-absorbent ceramic tiles.
- Ceramic tiles with special finishes.
- Glass mosaic.
- Natural stone and marble not prone to staining.
- Do not use on polished materials.

In the following applications, replace mixing water by **cl-stuk** additive:

- Wall tiles with mosaic-like patterns.
- DQS slabs and other kinds of marble agglomerate.

colorstuk especial n

| SAP | | Presentation | Europallet | P/EU |
|-----------|-----------|--------------|---------------|-----------|
| 100238236 | white | bag 2 kg | 432 kg/pallet | 6.30 p/kg |
| 100238229 | vainilla | bag 2 kg | 432 kg/pallet | 6.30 p/kg |
| 100204255 | oak | bag 2 kg | 432 kg/pallet | 2.91 p/kg |
| 100204261 | honey | bag 2 kg | 432 kg/pallet | 2.96 p/kg |
| 100243281 | iroko | bag 2 kg | 432 kg/pallet | 6.44 p/kg |
| 100234451 | elm | bag 2 kg | 432 kg/pallet | 3.15 p/kg |
| 100243271 | maple | bag 2 kg | 432 kg/pallet | 5.09 p/kg |
| 100204254 | beech | bag 2 kg | 432 kg/pallet | 2.85 p/kg |
| 100238261 | moka | bag 2 kg | 432 kg/pallet | 6.30 p/kg |
| 100234433 | wenge | bag 2 kg | 432 kg/pallet | 4.52 p/kg |
| 100204260 | doussie | bag 2 kg | 432 kg/pallet | 3.09 p/kg |
| 100238235 | nacare | bag 2 kg | 432 kg/pallet | 6.55 p/kg |
| 100238260 | graphite | bag 2 kg | 432 kg/pallet | 9.19 p/kg |
| 100204245 | ash | bag 2 kg | 432 kg/pallet | 2.85 p/kg |
| 100204554 | antracita | bag 2 kg | 432 kg/pallet | 3.18 p/kg |
| 100238251 | dark | bag 2 kg | 432 kg/pallet | 9.26 p/kg |

The colours shown are approximate and may vary for printing reasons.

cl-stuk

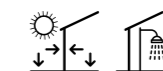

cl-stuk is a latex which mixed with cement-based grouts like colorstuk, reduces water absorption and enhances mechanical resistance and deformability. Specially recommended when laying ceramic outdoors and in permanently damp environments.

A latex additive that can be mixed with the colorstuk range of high-tech grout mortars in cases when increased mechanical resistance, reduced water absorption or improved flexibility is required.



Features:

- Water-based acrylic resins latex.
- Resistant to the most common chemicals.
- It reduces mortar water absorption.
- It enhances the adherence and deformability of the grouting material.
- It increases resistance to abrasion.
- Excellent resistance to UV rays and the effect of heat.
- Frost-resistant.

Coverage:

| Product | % | Liters | Kg/bag |
|----------------------|------|--------|--------|
| colorstuk 0-4 n | 30 % | 1,5 | 5 |
| colorstuk especial n | 32 % | 0,64 | 2 |

cl-stuk

| SAP | | Presentation | Europallet | P/EU |
|-----------|---------|--------------|---------------|-----------|
| 100004374 | cl-stuk | can 2 kg | 448 kg/pallet | 6.76 p/kg |
| 100004375 | cl-stuk | can 5 kg | 480 kg/pallet | 5.39 p/kg |

Recommended uses:

- Specially recommended in:
- Outdoor floor and wall tiles.
 - High traffic floor tiles.
 - Floor tiles on radiant heating.
 - Pools and damp environments.

It enhances grouting material performance in:

- Indoor wall tile coverings. Specially recommended for rectified tiles.
- Indoor floor tiles, including public buildings.

Materials:

Specially recommended in:

- Wall tiles with mosaic-like patterns.
- DQS slabs and other kinds of marble agglomerate.

It enhances grouting material performance in:

- Absorbent and non-absorbent ceramic tiles, including porcelain tiles.
- Glass mosaic.
- Natural stone and marble not prone to staining.

epotech aqua

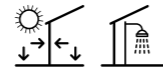

epotech aqua is a new line of epoxy putties for grouting tile joints. Two-component epoxy putty with no organic solvents. It is waterproof, it has outstanding chemical and mechanical properties and it is easy to apply. Specially recommended for application on mosaics and ceramic tiles with relief.

This material is suitable for grouting joints from 0 to 10 mm in floor and wall tiles, indoors and out. Excellent resistance to chemicals. Suitable for pools and permanently damp environments. Suitable as high adherence grouting material for ceramic tiles with any absorption level and format, for glass mosaic or natural stone.



Features:

- Two-component colored epoxy putty.
- Easy to apply and clean. This product is free of organic solvents and plasticizers
- Excellent joint color stability.
- Resistance to most chemicals and alkali, even in high concentrations.
- Waterproof joint, no water absorption.
- Excellent adherence and mechanical resistance.
- Tile joints up to 10 mm.
- Wide color range.

Recommended use:

- Tile joints with uniform color and shade, resistant to the passing of time.
- Floorings with built-in heating.
- Pools and damp environments.
- High traffic floor tiles
- Outdoor floorings protected against the presence of rising moisture
- Floorings and wall coverings in direct contact with chemicals. See technical sheet.

Substrates:

- All usual substrates for ceramic tiles laying.

Coverage:

- See the grouting materials table on page 150

Materials:

- Absorbent and non-absorbent ceramic tiles, including porcelain tiles.
- Tiles with mosaic-like patterns. Please refer to PORCELANOSA catalogues.
- Glass mosaic.
- Natural stone and marble not prone to staining.

| epotech aqua | | | | | |
|--------------|-----------|--|--------------|---------------|-------------------|
| SAP | | | Presentation | Europallet | P/EU |
| 100182223 | blanco | | can 1,5 kg | 315 kg/pallet | 19.24 p/kg |
| 100182217 | marfil | | can 1,5 kg | 315 kg/pallet | 18.93 p/kg |
| 100278474 | tabaco | | can 1,5 kg | 315 kg/pallet | 23.28 p/kg |
| 100182222 | beige | | can 1,5 kg | 315 kg/pallet | 18.93 p/kg |
| 100182208 | gris | | can 1,5 kg | 315 kg/pallet | 18.93 p/kg |
| 100278467 | manhattan | | can 1,5 kg | 315 kg/pallet | 23.28 p/kg |
| 100278329 | cemento | | can 1,5 kg | 315 kg/pallet | 23.28 p/kg |
| 100182213 | antracita | | can 1,5 kg | 315 kg/pallet | 18.93 p/kg |
| 100278500 | negro | | can 1,5 kg | 315 kg/pallet | 23.28 p/kg |

The colours shown are approximate and may vary for printing reasons.

Before using this product in any application not indicated in this catalogue, please perform a test or refer to the product's technical sheet.

epotech nature

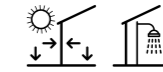

epotech nature is a new micro grain porcelain grout for the sealing of joints in ceramic tiles with designs inspired by nature. It has been specially developed for porcelain tiles that reproduce the appearance and texture of wood, such as PORCELANOSA Group's PAR-KER. Professional use.

This material is suitable for grouting tile joints up to 10 mm. in floorings and wall coverings, both indoors and outdoors. Excellent resistance to chemicals. Suitable for pools and permanently damp environments. Suitable as high adherence grouting material for ceramic tiles with any absorption level and format, for glass mosaic, or natural stone.



Characteristics:

- Two-component colored epoxy putty.
- Easy to apply and clean. This product is free of organic solvents and plasticizers.
- Excellent joint color stability.
- Resistance to most chemicals and alkali, even in high concentrations.
- Waterproof joint, no water absorption.
- Excellent adherence and mechanical resistance. Hypoallergenic and bacteriostatic.
- Tile joints up to 10 mm.
- Wide range of colors inspired by natural woods.

Recommended use:

- Floorings and wall coverings in natural wood-inspired ceramics.
- Tile joints with uniform color and shade, resistant to the passing of time.
- Floorings with built-in heating.
- Pools and damp environments.
- High traffic floor tiles
- Outdoor floorings protected against the presence of rising moisture
- Floorings and wall coverings in direct contact with chemicals. See technical sheet.

Substrates:

- All usual substrates for laying ceramic tiles.

Coverage:

- See the grouting materials table on page 150

Materials:

- Ceramic tiles with designs inspired by nature
- Absorbent and non-absorbent ceramic tiles, including porcelain tiles.
- Tiles with mosaic-like patterns. Please refer to PORCELANOSA catalogues.
- Glass mosaic.
- Natural stone and marble not prone to staining.

| epotech nature | | | | | |
|----------------|---------|--|--------------|---------------|-------------------|
| SAP | | | Presentation | Europallet | P/EU |
| 100177504 | ash | | can 1,5 kg | 315 kg/pallet | 22.65 p/kg |
| 100177514 | maple | | can 1,5 kg | 315 kg/pallet | 22.65 p/kg |
| 100177494 | beech | | can 1,5 kg | 315 kg/pallet | 22.65 p/kg |
| 100204262 | honey | | can 1,5 kg | 315 kg/pallet | 22.65 p/kg |
| 100177484 | oak | | can 1,5 kg | 315 kg/pallet | 22.65 p/kg |
| 100177505 | iroko | | can 1,5 kg | 315 kg/pallet | 22.65 p/kg |
| 100177513 | elm | | can 1,5 kg | 315 kg/pallet | 22.65 p/kg |
| 100177512 | doussie | | can 1,5 kg | 315 kg/pallet | 22.65 p/kg |
| 100177485 | wenge | | can 1,5 kg | 315 kg/pallet | 22.65 p/kg |

The colours shown are approximate and may vary for printing reasons.

Before using this product in any application not indicated in this catalog, please carry out a test or refer to the product's technical sheet.

epotech crystal

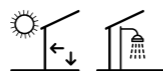

epotech crystal is an epoxy putty for grouting tile joints. Two-component putty with a translucent finish. It reflects the color of the tile or mosaic surrounding the joint. It features all the properties of epoxy putties: watertightness, high resistance to chemicals and mechanical properties. Specially recommended for application on mosaics and ceramic tiles with relief. Extra fine, micro grain porcelain grout.

This material is suitable for grouting joints up to 5 mm in floor and wall tiles indoors. Excellent resistance to chemicals in high concentrations. Suitable for permanently damp environments.



Certifications/Standards:

EN 13888 RG

Features:

- Extra fine, micro grain porcelain grout.
- Easy to apply and clean epoxy putty.
- Translucent appearance.
- High resistance to most acids and alkali, even in high concentrations.
- Waterproof joint, no water absorption.
- Excellent adherence and mechanical resistance.
- Prevents the development of fungi and bacteria.
- Tile joints up to 5 mm.

Recommended uses:

- Wall and floor tiles with minimum joint.
- Indoor floor and wall tiles.
- Mosaic or natural stone wall coverings.
- Wall tiles and mosaics with glass elements.
- PAR-KER floor coverings.
- Technical, porcelain floor coverings.

Substrates:

- All usual substrates for ceramic tiles laying.

Coverage:

- See the grouting materials table on page 150

Materials:

- Absorbent and non-absorbent ceramic tiles, including porcelain tiles.
- Glass mosaic.
- Wall tiles and mosaics with glass elements.
- Natural stone and marble not prone to staining.

| epotech crystal | | | |
|-----------------|--------------|---------------|------------|
| SAP | Presentation | Europallet | P/EU |
| 100126899 | can 3 kg | 264 kg/pallet | 25.18 p/kg |

Epoxy cleaning kit

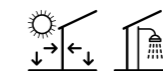

Cleaning kit for epoxy joint remains before their final hardening. It includes an epotech cleaner bottle, water-based detergent for cleaning off epoxy putties remains and stains..

It includes:

- 1 MMC handle epotech trowel
- 1 Epoxy sponge
- 1 Float for final cleaning + 3 scourers
- 1 200 ml epotech cleaner bottle



| Epoxy cleaning kit | |
|--------------------|-------------|
| SAP | P/EU |
| 100113684 | 74.24 p/kit |

epotech cleaner

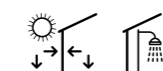

Water-based detergent for cleaning epoxy putties remains and stains. Specially recommended for cleaning remains of epotech aqua. Professional use.

Recommended uses:

- Cleaning of epoxy putties remains and films on ceramic tiles, glass mosaics and natural stones.



| epotech cleaner | | |
|-----------------|---------------|-----------|
| SAP | Presentation | P/EU |
| 100120428 | bottle 500 ml | 23.28 p/u |

Epoxy sponge



Cellulose cleaning sponge for epoxy joints

- Cleaning epoxy joints
- 100% vegetable cellulose sponge
- 1 unit



| Esponja epoxy | |
|---------------|----------|
| SAP | P/EU |
| 100085287 | 9.94 p/u |

s-107 n

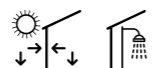

s-107 n is a neutral silicone putty for sealing joints. Specially recommended for sealing movement joints. Indoor and outdoor use.

This putty crosslinks in contact with dampness and does not give off odors, thus becoming an elastomer highly elastic and resistant to atmospheric agents.



Features:

- Single-component neutral silicone.
- High elasticity.
- Good adherence.
- Resistant to UV rays.
- Frost-resistant.

Recommended uses:

- Sealing joints even between materials sensible to chemical attack.
- Sealing movement joints in floors and walls.
- Sealing joints in ceramics, glass, metal and plastics.
- Sealing perimeter joints in wall tile coverings.
- Gluing ceramic materials on wood boards.

Substrates:

- All usual substrates for ceramic tiles laying.

Coverage:

- Joint de 2 x 2 mm 75.0 m
- Joint de 3 x 3 mm 33.3 m
- Joint de 5 x 3 mm 20.0 m
- Joint de 5 x 5 mm 12.0 m
- Joint de 8 x 4 mm 8.3 m

$$\text{Coverage} = \frac{300}{\text{joint width (mm)} \times \text{joint depth (mm)}} \text{ (ml/cartridge)}$$

| s-107 n | | | | | |
|-----------|--------------|--|------------------|-----------|----------|
| SAP | | | Presentation | Packaging | P/EU |
| 100005814 | blanco | | cartridge 300 ml | 25 ud/box | 9.06 p/u |
| 100005815 | transparente | | cartridge 300 ml | 25 ud/box | 7.70 p/u |
| 100120621 | marfil | | cartridge 300 ml | 25 ud/box | 9.06 p/u |
| 100120624 | tabaco | | cartridge 300 ml | 25 ud/box | 9.06 p/u |
| 100115950 | beige | | cartridge 300 ml | 25 ud/box | 9.06 p/u |
| 100005816 | gris | | cartridge 300 ml | 25 ud/box | 9.06 p/u |
| 100120620 | cemento | | cartridge 300 ml | 25 ud/box | 9.06 p/u |
| 100120608 | antracita | | cartridge 300 ml | 25 ud/box | 9.06 p/u |
| 100005817 | negro | | cartridge 300 ml | 25 ud/box | 9.06 p/u |

The colours shown are approximate and may vary for printing reasons.

Before using this product in any application not indicated in this catalogue, please perform a test or refer to the product's technical sheet.

s-502

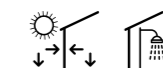

s-502 is a high-performance acetic silicone putty for sealing joints. Specially recommended for sealing joints in bathrooms and for sealing perimeter joints in wall tile coverings. It has anti-fungal properties that prevent the appearance of black spots in damp environments.

This reticular putty, when in contact with dampness gives off acetic acid, thus becoming an extraordinary elastic and resistant elastomer to atmospheric agents. Indoor use.



Features:

- Single-component acetic silicone.
- High elasticity. Can withstand movements up to 20% of the sealed joint width.
- Excellent adherence.
- Resistant to UV rays.

Recommended uses:

- Sealing joints in ceramics, glass, metal, plastics and painted surfaces.
- Sealing joints between ceramic wall coverings and ceramic bathroom fixtures, bathtubs, showers, or countertops in kitchens and bathrooms.
- Sealing perimeter joints in wall tile coverings.
- Sealing glass and woodwork.
- Sealing and gluing bathroom elements such as screens and cabins.
- Gluing ceramic materials on wood boards.

Substrates:

- Do not use on substrates which are sensible to the action of acids:
- Screeds and floors with cement mortar.
- Concrete

Coverage:

- 2 x 2 mm joint 77,5 m
- 3 x 3 mm joint 31,4 m
- 5 x 3 mm joint 20,6 m
- 5 x 5 mm joint 12,4 m
- 8 x 4 mm joint 8,6 m
- 8 x 6 mm joint 6,4 m

$$\text{Coverage} = \frac{310}{\text{joint width (mm)} \times \text{joint depth (mm)}} \text{ (ml/cartridge)}$$

| s-502 | | | | |
|-----------|--------------|------------------|-----------|----------|
| SAP | | Presentation | Packaging | P/EU |
| 100005809 | transparente | cartridge 310 ml | 24 ud/box | 9.50 p/u |
| 100005808 | blanco | cartridge 310 ml | 24 ud/box | 9.50 p/u |

Before using this product in any application not indicated in this catalogue, please perform a test or refer to the product's technical sheet.



p-404

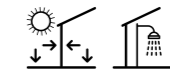

p-404 is polyurethane putty for sealing joints. Specially recommended for sealing movement joints outdoors. Indoor and outdoor use.,

This reticular putty in contact with dampness does not give off odors, thus becoming an extraordinary adherent, elastic and resistant elastomer to atmospheric agents.



Features:

- Single-component polyurethane putty.
- High elasticity.
- High adherence.
- Resistant to UV rays.
- Frost-resistant.

Recommended uses:

- Sealing joints even between materials sensible to chemical attack.
- Sealing movement joints in floors and walls.
- Bonding of building materials like ceramics, concrete, roof tiles, wood, aluminium, polyester or PVC.
- Gluing ceramic materials on metal or wood boards.
- Gluing Concept XPS panels.

Substrates:

- All usual substrates for ceramic tiles laying.

Materials:

- Ceramic tiles and glass mosaic.
- Glass.
- Metal.
- Plastic material, PVC.
- Concrete slabs.
- Wood.
- Concept XPS panels.

Coverage:

- 2 x 2 mm joint 75 m
- 3 x 3 mm joint 33,33 m
- 5 x 3 mm joint 20 m
- 5 x 5 mm joint 12 m
- 8 x 4 mm joint 9,37 m
- 8 x 6 mm joint 6,25 m

$$\text{Coverage} = \frac{300}{\text{joint width (mm)} \times \text{joint depth (mm)}} \text{ (ml/cartridge)}$$

| p-404 | | | | |
|--------------|--------|---------------------|------------------|-----------------|
| SAP | | Presentation | Packaging | P/EU |
| 100005818 | blanco | cartridge 300 ml | 25 ud/box | 7.68 p/u |
| 100005819 | gris | cartridge 300 ml | 25 ud/box | 7.68 p/u |
| 100005820 | negro | cartridge 300 ml | 25 ud/box | 7.92 p/u |

Before using this product in any application not indicated in this catalogue, please perform a test or refer to the product's technical sheet.

self-leveling spacers

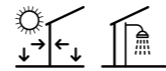

Leveling system for ceramic tiles. Eases ceramic tile laying and guarantees a perfectly flat surface of the final installation. The system consists of a new type of spacer with adjustable height that levels the surrounding tiles and prevents them from moving.

Specially recommended when tile, design or use features demand a perfect finish, with an even, seamless surface.

Features:

- Guarantees tiles are even.
- Prevents tiles from moving due to laying errors or due to mortar setting.
- Reduces retouching and laying times.
- Suitable for 0,5-5 mm wide joints.
- Suitable for floor and wall tiles of thickness between 7-15 mm. For thinner tiles use the supplementary lifting pieces
- The system consists of a spacer, a wedge and an adjusting tool.
- Wedges are recoverable, only the spacers are consumed.

Recommended uses:

- Wall and floor tiles with minimum joint.
- Large format floor tiles.
- Laying of rectified wall tiles.
- Tiles with reduced thickness: XLIGHT and XTONE
- Interlocking floor designs.
- Glued facades.
- Essential to place the ceramic by the method of thin layer and double gluing of the pieces

Substrates:

- All usual substrates for ceramic tiles laying.

Materials:

- Before using the self-levelling spacers system, carry out a preliminary test with the type of wall or floor tiles to be installed and check that the tile is not damaged during the removal of the spacer, especially in textured or rectified tiles without bevelling and mosaics with 3D texture

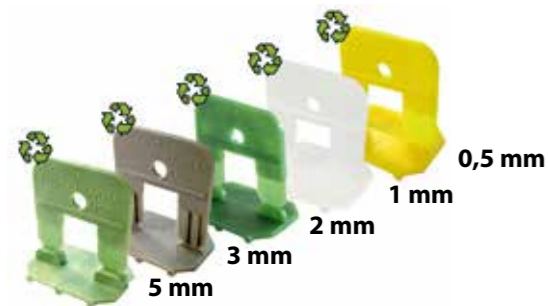

self-leveling spacers for tiles 3 to 15 mm thick

| SAP | | Presentation | Europallet | P/EU |
|-----------|---------------|--------------|-----------------|-------------|
| 100108031 | wedge | 100 ud/bag | 700 bags/pallet | 22.63 p/bag |
| 100108032 | wedge | 300 ud/bag | 240 bags/pallet | 52.47 p/bag |
| 100095383 | wedge | 500 ud/bag | 140 bags/pallet | 99.70 p/bag |
| 100207811 | 0,5 mm spacer | 100 ud/bag | 600 bags/pallet | 15.81 p/bag |
| 100207797 | 0,5 mm spacer | 300 ud/bag | 200 bags/pallet | 43.24 p/bag |
| 100207740 | 0,5 mm spacer | 500 ud/bag | 120 bags/pallet | 71.02 p/bag |
| 100108026 | 1 mm spacer | 100 ud/bag | 600 bags/pallet | 15.81 p/bag |
| 100108027 | 1 mm spacer | 300 ud/bag | 200 bags/pallet | 43.24 p/bag |
| 100108028 | 1 mm spacer | 500 ud/bag | 120 bags/pallet | 71.02 p/bag |
| 100108029 | 2 mm spacer | 100 ud/bag | 600 bags/pallet | 15.81 p/bag |
| 100108030 | 2 mm spacer | 300 ud/bag | 200 bags/pallet | 43.24 p/bag |
| 100095382 | 2 mm spacer | 500 ud/bag | 120 bags/pallet | 71.02 p/bag |
| 100109070 | 3 mm spacer | 100 ud/bag | 600 bags/pallet | 15.81 p/bag |
| 100109071 | 3 mm spacer | 300 ud/bag | 200 bags/pallet | 43.24 p/bag |
| 100109072 | 3 mm spacer | 500 ud/bag | 120 bags/pallet | 71.02 p/bag |
| 100275166 | 5 mm spacer | 100 ud/bag | 600 bags/pallet | 15.81 p/bag |
| 100275156 | 5 mm spacer | 300 ud/bag | 200 bags/pallet | 43.24 p/bag |
| 100275138 | 5 mm spacer | 500 ud/bag | 120 bags/pallet | 71.03 p/bag |

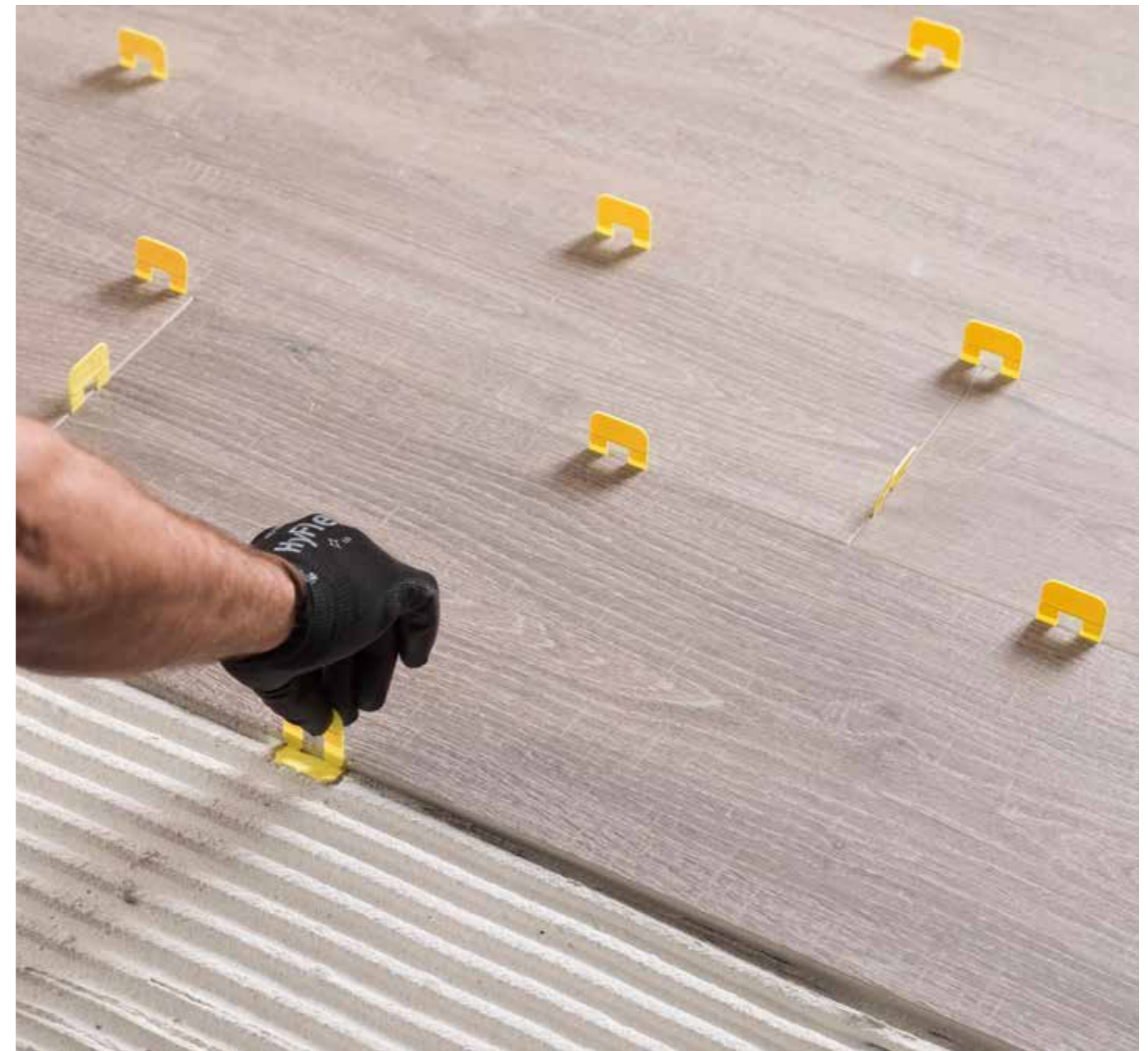

self-leveling spacers for tiles 16 to 22 mm thick

| SAP | | Presentation | P/EU |
|-----------|-------------|--------------|-------------|
| 100225039 | 2 mm spacer | 100 ud/bag | 15.81 p/bag |
| 100315637 | 5 mm spacer | 100 ud/bag | 15.10 p/bag |
| 100315638 | 5 mm spacer | 300 ud/bag | 42.68 p/bag |
| 100315639 | 5 mm spacer | 500 ud/bag | 68.11 p/bag |

complements

| SAP | | Presentation | P/EU |
|-----------|--------------------------|--------------|-------------|
| 100213808 | 0,5 mm spacer system kit | kit* | 84.57 p/kit |
| 100108034 | 1 mm spacer system kit | kit* | 84.57 p/kit |
| 100109073 | 2 mm spacer system kit | kit* | 84.57 p/kit |
| 100109074 | 3 mm spacer system kit | kit* | 84.57 p/kit |
| 100275157 | 5 mm spacer system kit | kit* | 84.57 p/kit |
| 100123264 | supplementary lift piece | 50 ud/bag | 3.93 p/bag |
| 100095386 | adjustment tool | unit | 53.40 p/u |

*kit: 1 adjustment tool, 100 spacers and 100 wedges

GROUTING COVERAGE

| a x b | c | colorstuk 0-4 | colorstuk especial | colorstuk rapid | epotech aqua | epotech nature |
|-------------|------|-------------------|--------------------|-------------------|-------------------|-------------------|
| cm | mm | gr/m ² | gr/m ² | gr/m ² | gr/m ² | gr/m ² |
| 2,5 x 2,5 | 4 | 480 | 496 | 512 | 486 | 493 |
| 5 x 5 | 4 | 240 | 248 | 256 | 243 | 246 |
| 7,5 x 7,5 | 4 | 160 | 165 | 171 | 162 | 164 |
| 10 x 10 | 6 | 180 | 186 | 192 | 182 | 185 |
| 20 x 31,6 | 9 | 110 | 114 | 118 | 112 | 113 |
| 31,6 x 44,6 | 9 | 73 | 75 | 78 | 74 | 75 |
| 31,6 x 59,2 | 9 | 66 | 68 | 70 | 66 | 67 |
| 31,6 x 90 | 9 | 58 | 60 | 62 | 58 | 59 |
| 33,3 x 100 | 9,2 | 55 | 57 | 59 | 56 | 57 |
| 45 x 120 | 10,5 | 48 | 50 | 51 | 49 | 49 |
| 21,5 x 65,9 | 11 | 102 | 105 | 109 | 103 | 104 |
| 14,3 x 90 | 11 | 134 | 138 | 143 | 136 | 137 |
| 22 x 90 | 11 | 93 | 96 | 100 | 95 | 96 |
| 19,3 x 120 | 11 | 99 | 103 | 106 | 101 | 102 |
| 19,3 x 180 | 12 | 103 | 107 | 110 | 105 | 106 |
| 29,4 x 120 | 11 | 70 | 72 | 75 | 71 | 72 |
| 29,4 x 180 | 12 | 71 | 74 | 76 | 72 | 73 |
| 25 x 150 | 10,5 | 74 | 76 | 78 | 74 | 75 |
| 44,3 x 44,3 | 10 | 68 | 70 | 72 | 69 | 70 |
| 43,5 x 65,9 | 11 | 63 | 65 | 67 | 64 | 65 |
| 40 x 80 | 11 | 62 | 64 | 66 | 63 | 64 |
| 45 x 90 | 11 | 55 | 57 | 59 | 56 | 56 |
| 59,6 x 59,6 | 11 | 55 | 57 | 59 | 56 | 57 |
| 80 x 80 | 12 | 45 | 47 | 48 | 46 | 46 |
| 59,6 x 120 | 12 | 45 | 47 | 48 | 46 | 46 |
| 100 x 100 | 11 | 33 | 34 | 35 | 33 | 34 |
| 120 x 120 | 12 | 30 | 31 | 32 | 30 | 31 |
| 100 x 100 | 3,5 | 11 | 11 | 11 | 11 | 11 |
| 100 x 100 | 6 | 18 | 19 | 19 | 18 | 18 |
| 120 x 120 | 6 | 15 | 16 | 16 | 15 | 15 |
| 100 x 300 | 3,5 | 7 | 7 | 7 | 7 | 7 |
| 120 x 250 | 6 | 11 | 11 | 12 | 11 | 11 |

SELF-LEVELING SPACERS COVERAGE

| a | b | a x b | c | Spacers / m ² | |
|------|------|-------------|------|--------------------------|---------------|
| | | | | Aligned | Staggered 3/4 |
| cm | cm | cm x cm | mm | | |
| 20 | 31,6 | 20 x 31,6 | 9 | 64 | - |
| 31,6 | 44,6 | 31,6 x 44,6 | 9 | 29 | - |
| 31,6 | 59,2 | 31,6 x 59,2 | 9 | 22 | - |
| 31,6 | 90 | 31,6 x 90 | 9 | 18 | - |
| 33,3 | 100 | 33,3 x 100 | 9,2 | 16 | - |
| 45 | 120 | 45 x 120 | 10,5 | 12 | - |
| 21,5 | 65,9 | 21,5 x 65,9 | 11 | 36 | 43 |
| 14,3 | 90 | 14,3 x 90 | 11 | 39 | 47 |
| 22 | 90 | 22 x 90 | 11 | 26 | 31 |
| 19,3 | 120 | 19,3 x 120 | 11 | 26 | 31 |
| 19,3 | 180 | 19,3 x 180 | 12 | 21 | 23 |
| 29,4 | 120 | 29,4 x 120 | 11 | 18 | 20 |
| 29,4 | 180 | 29,4 x 180 | 12 | 14 | 16 |
| 25 | 150 | 25 x 150 | 10,5 | 16 | 19 |
| 44,3 | 44,3 | 44,3 x 44,3 | 10 | 21 | - |
| 43,5 | 65,9 | 43,5 x 65,9 | 11 | 18 | - |
| 40 | 80 | 40 x 80 | 11 | 16 | - |
| 45 | 90 | 45 x 90 | 11 | 13 | - |
| 59,6 | 59,6 | 59,6 x 59,6 | 11 | 12 | - |
| 80 | 80 | 80 x 80 | 12 | 10 | - |
| 59,6 | 120 | 59,6 x 120 | 12 | 9 | - |
| 100 | 100 | 100 x 100 | 11 | 6 | - |
| 120 | 120 | 120 x 120 | 12 | 6 | - |
| 100 | 100 | 100 x 100 | 3,5 | 6 | - |
| 100 | 100 | 100 x 100 | 6 | 6 | - |
| 120 | 120 | 120 x 120 | 6 | 6 | - |
| 100 | 300 | 100 x 300 | 3,5 | 4 | - |
| 120 | 250 | 120 x 250 | 6 | 4 | - |

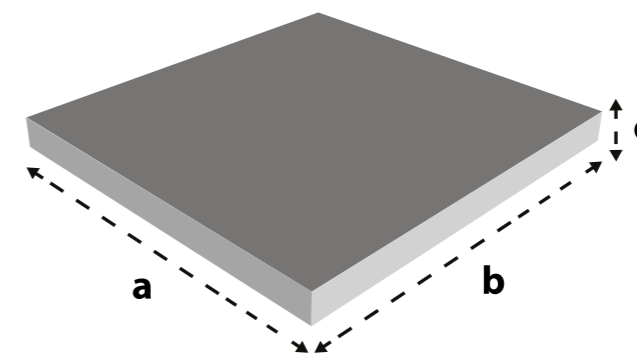



SUBSTRATE PREPARATION PRODUCTS

ELECTRIC RADIANT FLOOR HEATING

Electric Radiant Floor Heating, **155**

ACOUSTIC INSULATION

fonopac r, **157**

SELF-LEVELING MORTARS

level 1 pro, **158** | level 3, **159**

PRIMERS

super-prim, **160** | uniprim, **161**

CLEANING PRODUCTS

acid net 1L, **162** | porce-clean, **162** | basic-gel 1L, **162**
epotech cleaner, **163** | non slip tile, **163**



electric radiant floor heating

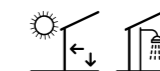

The electric radiant floor heating from butech, also known as **ERFH**, is a heating system with an electric element for radiant floors, specially designed to provide comfort in ceramic floors in bathrooms and, in general, all kinds of floors walked barefoot. The ERFH system consists of an electric element and a digital thermostat timer.

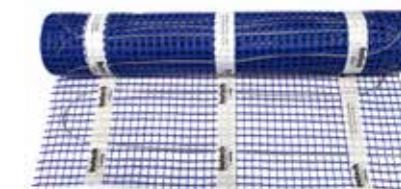

The electric element is a 1.8 mm diameter heating wire that transforms electric energy into heating. Never cut this kind of wire. Maximum power is 150 W/m².



touch control

User-friendly digital thermostat that regulates the turn on and off and heating power of the system.

Features:

- Easy, quick and economic installation. No maintenance costs.
- Avoids the installation of radiators on the walls.
- Ideal for homes not connected to the gas distribution network.
- Applicable in floors where a water pipe heating cannot be installed.
- More uniform heat distribution to all the surface of the room.
- More pleasant elevation of heat distribution.
- No air movement.

Power: 150 W/m²
 Voltage: 230 V – 50/60 Hz
 Maximum charge: 16 Amp / 230 V max
 Maximum temperature: + 40°C

Recommended uses:

- Radiant heating in home refurbishings.
- General heating of homes.
- Comfort and auxiliary heating in bathrooms and dressing rooms.
- Comfort and auxiliary heating in spas and premises with permanent dampness.
- Comfort and auxiliary heating in locker rooms, recreational and sports premises.
- Heating of indoor areas with high ceilings.
- Temporary heating of workplaces.
- Do not use in outdoor floors.

Guarantee:

- Thermostat guarantee: 3 years
- Electric Mat guarantee: Lifetime

Materials:

- Absorbent ceramics and porcelain tiles (water absorption < 0.5% as per EN-ISO 10545-3).
- Natural stone and marble not prone to staining.
- Wooden floors bonded to the substrate.
- Do not use under floating floors.
- Do not use under material sensible to heat.

Installation:

- Choose the radiant Mat that suits the surface to be heated.
- In case of surfaces bigger than 10 m², connect Mats in parallel in a connection box.
- Do not connect Mats with a total surface bigger than 20 m² to one thermostat.
- Never cut the heating wire.
- Do not install under static elements and less than 15-20 cm from the walls.
- Never drill a floor where a radiant heating has been installed.

| electric radiant floor heating | | | |
|--------------------------------|------------------------|------------------|-------------------|
| SAP | Premium ERFH | Presentation | P/EU |
| 100232008 | 1 m ² Mat | 1 Mat/box | 163.89 p/u |
| 100232081 | 1.5 m ² Mat | 1 Mat/box | 188.79 p/u |
| 100232053 | 2 m ² Mat | 1 Mat/box | 210.41 p/u |
| 100232009 | 2.5 m ² Mat | 1 Mat/box | 240.80 p/u |
| 100232090 | 3 m ² Mat | 1 Mat/box | 268.95 p/u |
| 100232082 | 4 m ² Mat | 1 Mat/box | 347.91 p/u |
| 100232016 | 5 m ² Mat | 1 Mat/box | 425.80 p/u |
| 100232080 | 10 m ² Mat | 1 Mat/box | 731.59 p/u |
| 100305735 | 10GM Thermostat | 1 thermostat/box | 371.93 p/u |

Before using this product in any application not indicated in this catalogue, please perform a test or refer to the product's technical sheet.

fonopac r



fonopac r is a multilayer sheet for isolating ceramic or natural stone floors against impact noise. Made of synthetic rubber, it combines a good Acoustic insulation with a low compressibility, allowing for direct laying of ceramic tiles. Specially recommended for refurbishing of floors.

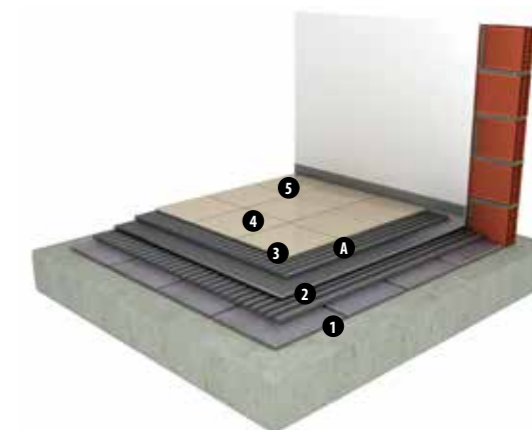

1- floor slab
2- old floor tile
3- fonopac r
4- floor tile
5- bandin
A- cement-based adhesive + unilax

Features:

- Sheet made of synthetic rubber and TPO.
- Allows direct laying of tiles, with no need for compression layers.
- Compatible with cement-based adhesives.

- Dimensions: 60 x 100 cm
- Final thickness: 3 mm
- Weight: 1,36 kg / m²

- Weighted reduction of impact sound pressure level according to standard ISO 717-2

$$\Delta L_w = 16 \text{ dB}$$

Installation:

- Cover the whole floor perimeter with acoustic isolating tape bandin.
- Laying of the sheets by the thin-bed method, with super-one n adhesive mixed with unilax.
- Seal the joints between sheets with cintex tape.
- Be extremely cautious when laying the sheet to avoid tears and other acoustic bridges.
- Once fonopac r sheets laid, lay the ceramic floor with super-one n mixed with unilax.

Recommended uses:

- Reduces impact noise in indoor floors.
- Reduces impact noise in refurbishing of floors.

Materials:

- Ceramic floors and similar products adhered to the substrate.
- Laminate floors.

Substrates:

- Cement covered floors.
- Existing floors.

fonopac r

| SAP | | Presentation | P/EU |
|-----------|---|---|-------------------------------|
| 100082628 | fonopac r | sheets 100 x 60 cm | 20.52 p/m ² |
| 100004402 | bandin | roll 30 m | 18.84 p/roll |
| 100004399 | cintex | roll 50 m | 24.26 p/roll |
| 100004463 | Kit fonopac r fonopac r super-one n bandin cintex | Total 8,4 m ² 14x 100 x 60 cm sheets 2x 25 Kg bags 1x 30 m roll 1x 50 m roll | 352.97 p/kit |

Before using this product in any application not indicated in this catalogue, please perform a test or refer to the product's technical sheet.

level 1 pro



level 1 pro is a fast hardening, self-leveling mortar for leveling and regularizing substrates for all kinds of floor tiles. Specially recommended for laying rectified ceramic floor tiles.

It is formulated for creating 2 to 10 mm floor substrates. It features good workability, fast-setting times, and a high mechanical performance. It allows to prepare floors well levelled, for a correct and quick fixing of rectified ceramic tiles.



Certifications/Standards:
EN 13813 CT-C20-F5

Features:

- Single-component, self-leveling mortar.
- Excellent adherence.
- Fast hardening. Ready for traffic in 4-5 hours.
- Application thickness between 2 and 10 mm.
- Easy application with a straight edge trowel or scraper. Pumpable.
- Indoor use.
- Mixing water. 6.0 l per 25 kg bag.

Recommended uses:

- Substrate regularization in refurbishing jobs.
- Indoor large format ceramic floor tile coverings.
- Indoor rectified floor tile coverings.
- Indoor floor tile coverings with a 1 mm joint.
- Laminate floating floors.
- Synthetic floors and carpet.
- Do not use in outdoor floors.
- Do not use on floors with radiant heating.

Substrates:

- For cement-based, concrete or anhydrite substrates, first apply **uniprim**.
- For existing ceramic substrates, first apply **super-prim**.

Materials:

- Large format ceramics.
- Porcelain tiles with a water absorption < 0.5% as per EN-ISO 10545-3.
- Natural stone and marble not prone to staining.
- Laminate floors and parquet.

Coverage:

| Substrate | Coverage |
|----------------------|--|
| Self-leveling floors | 1.4 kg per m ² and thickness millimeter |

| level 1 pro | | | | |
|-------------|-------------|--------------|----------------|-----------|
| SAP | | Presentation | Europallet | P/EU |
| 100141151 | level 1 pro | bag 25 kg | 1000 kg/pallet | 0.96 p/kg |

Before using this product in any application not indicated in this catalogue, please perform a test or refer to the product's technical sheet.

level 3



level 3 is a fast hardening, self-leveling mortar with fibres for leveling and regularizing substrates for all kinds of floor tiles. Specially recommended for laying ceramic floor tiles with a minimal joint indoors.

It is formulated for creating 3 to 30 mm floor substrates. It features good workability, fast-setting times, and a high mechanical performance. It allows to prepare floors well levelled, for a correct and quick fixing of rectified ceramic tiles.



Certifications/Standards:
EN 13813 CT C25-F5

Features:

- Compressive strenght ≥ 25 N/mm²
- Flexural strenght ≥ 5 N/mm²
- Single-component, self-leveling mortar.
- Excellent adherence. Flexible.
- High fibre content.
- Application thickness between 3 and 30 mm.
- Easy application with a straight edge trowel or scraper.
- Indoor use.
- Mixing water: 4.25 – 4.50 l per 25 kg bag

Recommended uses:

- Indoor large format floor tile coverings.
- Indoor large format rectified floor tile coverings.
- Indoor floor tile coverings with a 1 mm joint.
- Floor tiles with radiant heating.

Substrates:

- Cement-based substrate, previously apply **uniprim**.
- Glazed ceramic tiles and wood substrates, previously apply **super-prim**.

Materials:

- Large format floor tiles.
- Porcelain tiles (water absorption < 0.5% as per EN-ISO 10545-3).
- Natural stone and marbles.

Coverage:

| Substrate | Coverage |
|----------------------|--|
| Self-leveling floors | 1.4 kg per m ² and thickness millimeter |

| level 3 | | | | |
|-----------|---------|--------------|----------------|-----------|
| SAP | | Presentation | Europallet | P/EU |
| 100104577 | level 3 | bag 25 kg | 1000 kg/pallet | 1.53 p/kg |

Before using this product in any application not indicated in this catalogue, please perform a test or refer to the product's technical sheet.

super-prim

super-prim is a water-based acrylic resin primer with silica arids, used for preparing substrates prior to using adhesives, self-leveling mortars and mortar screeds. It reduces water absorption and improves the consistency of cement-based substrates. Professional use.

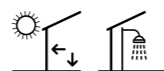

Features:

- Water-based, acrylic resin latex with silica arids.
- It enhances the adherence of cement mortars on glazed wall coverings.
- It improves the bonding material setting time.
- It reduces substrate water absorption.
- It increases cohesion of the substrate.
- Easy application with a paint roller or a wide paint-brush. Can be applied with airless spray.
- Indoor and outdoor use.
- Do not dilute with water or mix with any other liquids.

Recommended uses:

- Primer for self-leveling mortars on highly absorbent or existing ceramic tile coverings.
- Ceramic tiles on cement-based substrates with weak consistency or existing ceramic tile coverings.
- Ceramic floor coverings on anhydrite substrates or ceramic wall coverings on plaster or molding plaster.
- Mortar screeds on brick partition walls or concrete block walls.
- Mortar screeds on ceramic tile or natural stone floors.
- Do not use in substrates subject to dampness increases.

Substrates:

- Ceramic brick partition walls.
- Cement covered floors and walls.
- Concrete slabs and aerated concrete blocks.
- Anhydrite-covered floors and plastered walls.
- Indoor ceramic floor and wall tiles.
- Indoor wood boards.
- Indoor metal sheets.

Coverage:

| Substrate | Coverage |
|---------------|-----------------------------|
| Non absorbent | 200 - 250 gr/m ² |
| Absorbent | 250 -300 gr/m ² |

| super-prim | | | | |
|------------|------------|--------------|---------------|------------|
| SAP | | Presentation | Europallet | P/EU |
| 100123220 | super-prim | can 10 kg | 640 kg/pallet | 10.69 p/kg |

Before using this product in any application not indicated in this catalogue, please perform a test or refer to the product's technical sheet.

uniprim

uniprim is a water-based primer made of synthetic resins for the insulation of plaster, anhydrite and molding plaster substrates, prior to the use of cement-based adhesives. It reduces water absorption and improves the consistency of cement-based substrates

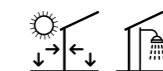

C2-type cement-based adhesives can be used to lay ceramic tiles quickly and efficiently on plaster, anhydrite and molding plaster substrates. It reduces the level of absorption of highly absorbent substrates, preventing cement-based adhesives from drying out too quickly and thus ensuring that they set properly. Priming prior to the application of self-leveling mortars on absorbent substrates, avoiding the appearance of bubbles or cracks because of a fast drying.

Features:

- Water-based synthetic resins primer.
- Once dry, it leaves a film over the substrate, which in plaster-based substrates prevents contact and chemical reaction with cement-based adhesives. It prevents ettringite buildup.
- It reduces substrate water absorption.
- It improves the bonding material setting time.
- It increases cohesion of the substrate.
- Easy application with a paint roller or a wide paint-brush.
- Indoor and outdoor use.

Recommended uses:

- Wall tiles on plaster or molding plaster substrates.
- Floor tiles on anhydrite substrates.
- Ceramic tiles on cement-based substrates with weak consistency.
- Priming required prior to the use of self-leveling compounds.

Substrates:

- Plasterboards and plastered walls.
- Anhydrite floor coverings.
- Cement-based substrates with high water absorption.
- Plasterboards.
- Untreated partition walls for laying tiles.

Coverage:

| Substrate | Coverage |
|-----------------------------|-----------------------------|
| Anhydrite/plaster substrate | 100 - 200 gr/m ² |

| uniprim | | | | |
|-----------|---------|--------------|---------------|-----------|
| SAP | | Presentation | Europallet | P/EU |
| 100004384 | uniprim | can 5 kg | 480 kg/pallet | 6.60 p/kg |
| 100004387 | uniprim | can 20 kg | 560 kg/pallet | 6.16 p/kg |

Before using this product in any application not indicated in this catalogue, please perform a test or refer to the product's technical sheet.

acid net 1L

acid net is an acid detergent for cleaning ceramic floor and wall tiles. It dissolves all kinds of cement debris without damaging coverings or cement based joints like colorstuk.

Recommended uses:

- Cleaning of remains of adhesives and cement-based grouting materials in floor and wall tiles
- Cleaning of efflorescences and salts remains.
- Cleaning of plaster remains and plaster-based remains.
- Cleaning of lime remains and film.
- Cleaning of glazed substrates prior to laying new tiles.

Coverage:

Dilution 1: 1 with clear water 90-100 gr / m²
 Dilution 1: 2 with clear water 45-50 gr / m²



| acid net 1L | | | | |
|-------------|----------|--------------|------------|-----------|
| SAP | | Presentation | Box | P/EU |
| 100120423 | acid net | bottle 1L | 12 bottles | 12.47 p/u |

porce-clean

Neutral detergent for cleaning ceramic and natural stone floor coverings. High degreasing power for a deep and perfect cleaning. Fast drying. Indoor and outdoor use.

Recommended uses:

- Regular cleaning of ceramic wall tiles.
- Cleaning of remains of wax, oil or grease from floor and wall tiles .

Coverage:

10 l of clean water 100-200 ml



| porce-clean | | | | |
|-------------|-------------|--------------|------------|-----------|
| SAP | | Presentation | Box | P/EU |
| 100120431 | porce-clean | bottle 1L | 12 bottles | 11.11 p/u |

basic gel 1L

Concentrated alkaline detergent developed for cleaning ceramic tiles in general. terracotta and antiqued marble. It removes all kinds of oils, varnishes, paints, wax and home stains. Specially effective for etching former treatments.

Recommended uses:

- Intensive cleaning of ceramic wall tiles.
- Cleaning of remains of wax, oil or grease from floor and wall tiles .
- Cleaning of glazed substrates prior to laying new tiles.



| basic gel 1L | | | | |
|--------------|--------------|--------------|------------|-----------|
| SAP | | Presentation | Box | P/EU |
| 100120425 | basic gel 1L | bottle 1L | 12 bottles | 14.87 p/u |

*Given the wide variety of ceramic materials, glass mosaics and natural stones, we recommend to check with your tile provider about chemical resistance of the tiles before applying any cleaning product.

Before using any cleaning product, please perform a test or refer to the product's technical sheet.

epotech cleaner

Water-based detergent for cleaning epoxy putties remains and stains. Specially recommended for cleaning remains of epotech aqua. Professional use.

Recommended uses:

- Cleaning of epoxy putties remains and films on ceramic tiles, glass mosaics and natural stones.

Coverage for 2 mm joint:

| | | |
|------|--------------|----------------------------|
| Tile | 200 x 316 cm | 20 m ² /package |
| Tile | 200 x 446 cm | 30 m ² /package |
| Tile | 316 x 596 cm | 33 m ² /package |
| Tile | 316 x 900 cm | 37 m ² /package |

| epotech cleaner | | | | |
|-----------------|-----------------|---------------|------------|-----------|
| SAP | | Presentation | Box | P/EU |
| 100120428 | epotech cleaner | bottle 500 ml | 20 bottles | 23.28 p/u |



non-slip tile

Non-slip treatment for glazed and unglazed ceramic tiles reducing the risk of slip and fall accidents. Indoor and outdoor use.

The non-slip treatment reacts with the ceramic tiles surface, generating thousands of microscopic bowls. These evenly distributed engravings increase the contact surface and, in the presence of water, produce a suction between the covering and the foot. This effect increases the coefficient of friction and reduces the risk of slip and fall accidents.

Recommended uses:

- Glazed and non-glazed ceramic floor tile coverings.
- Indoor and outdoor floor tile coverings.
- Built in shower trays.
- Do not apply on fibre shower trays and bathtubs.
- Do not apply on materials which are sensible to acid attack, like limestones or mortar substrates.

Coverage:

Ceramic tile 200 gr/m²

| non-slip tile | | | | |
|---------------|---------------|---------------|------------|-----------|
| SAP | | Presentation | Box | P/EU |
| 100120430 | non-slip tile | bottle 500 ml | 20 bottles | 38.81 p/u |

*Given the wide variety of ceramic materials, glass mosaics and natural stones, we recommend to check with your tile provider about chemical resistance of the tiles before applying any cleaning product.

Before using any cleaning product, please perform a test or refer to the product's technical sheet.



SHOWER TRAYS AND WATERPROOFING

SHOWER DECK SYSTEM

shower deck system, **168**

CONCEPT XPS SHOWER TRAYS

Concept xps shower trays, **168** | Standard shower trays, **170**

Refurbishing shower trays, **175** | Custom shower trays, **176**

Bespoke standard shower trays, **176** | Bespoke refurbishing shower trays, **178**

CONCEPT XPS PANELS

Concept xps panels, **180** | Fixing elements for concept xps panels, **181**

WATERPROOFING

imperband standard kit, **182** | Imperband refurbishing kit n, **183**

Linear grates, **184** | Squared grates, **187**

imperbox, **188** | imperband, **189** | sylastic Premium, **191**

DRAINAGE

pool deck, **192** | Terrace drain, **194** | Bathroom drain, **195**

DECOUPLING

butech anti-cracking mat, **196** | lamitech n, **197**

SHOWER DECK SYSTEM

shower deck system

New shower tray concept with concealed drain for the most exclusive bathrooms. This innovative shower tray system lets us create a sense of continuity with the rest of the bathroom floor because the slopes are concealed under the floor. Drainage is achieved through the open joints and does not require the installation of an evacuation grid.

The **shower deck system** is a shower tray made up by a polyurethane base coated with thermoset polymers, especially designed to to have ceramic plates installed. Specially recommended for bathroom renovations.

Features:

- Flat shower tray without slopes.
- Polyurethane base coated with thermoset polymers.
- Drain concealed from sight.
- Ultra-slim shower tray; only 30 mm in height.
- Easy to clean and high resistance to domestic-use detergents.
- Virtually no maintenance, especially compared with wooden floors.
- Thermal insulation.
- Easy installation and assembly.

Installation:

- Concrete floor slabs.
- Cement covered floors.
- Wood flooring.

Physical properties of the shower deck systems tray:

| | |
|--------------------------------|--|
| Color | Black |
| Weight | 5 Kg/m ² |
| Compression resistance | 2000 KpA |
| Capillarity | 0 |
| Limit application temperature. | -70/+130 °C |
| Supply thicknesses (mm) | 30 mm |
| Tolerances | Length and width: ± 2 mm Thickness: +/- 2 mm Squaring: < 2 mm/m |

Recommended use:

- Shower trays and cabins in designer bathrooms.
- Shower trays in public buildings.
- Applications where it is necessary to eliminate architectural barriers.
- Accessible bathrooms.

Materials:

Porcelain tiles with a thickness of 10mm or above. For models with a lower thickness, stick a reinforcing sheet on the back of the piece; check characteristics with the Butech Technical Department

- KRION slabs with a thickness of 10mm or above
- Anti-slip porcelain tile plates
- STON-KER antislip
- PAR-KER antislip
- SOLID-KER antislip

Components:

- **shower deck** tray
- **imperband** 5 m²
- Non-return valve drain. Output Ø 40 mm and 0.52 l/s
- 5 linear meters lami-band 200 roll
- Drain reinforcement piece
- P-404 tube
- Protection plate
- Manhole key
- PVC leveling profiles of 14X14X2000 mm to reference the height and finish of the ceramics (2 pcs)
- Profiles for union of ceramic pieces of 35 x 14 x longest measurement of the tray, max. 2000 mm (2 pcs)
- Ceramic tiles not included

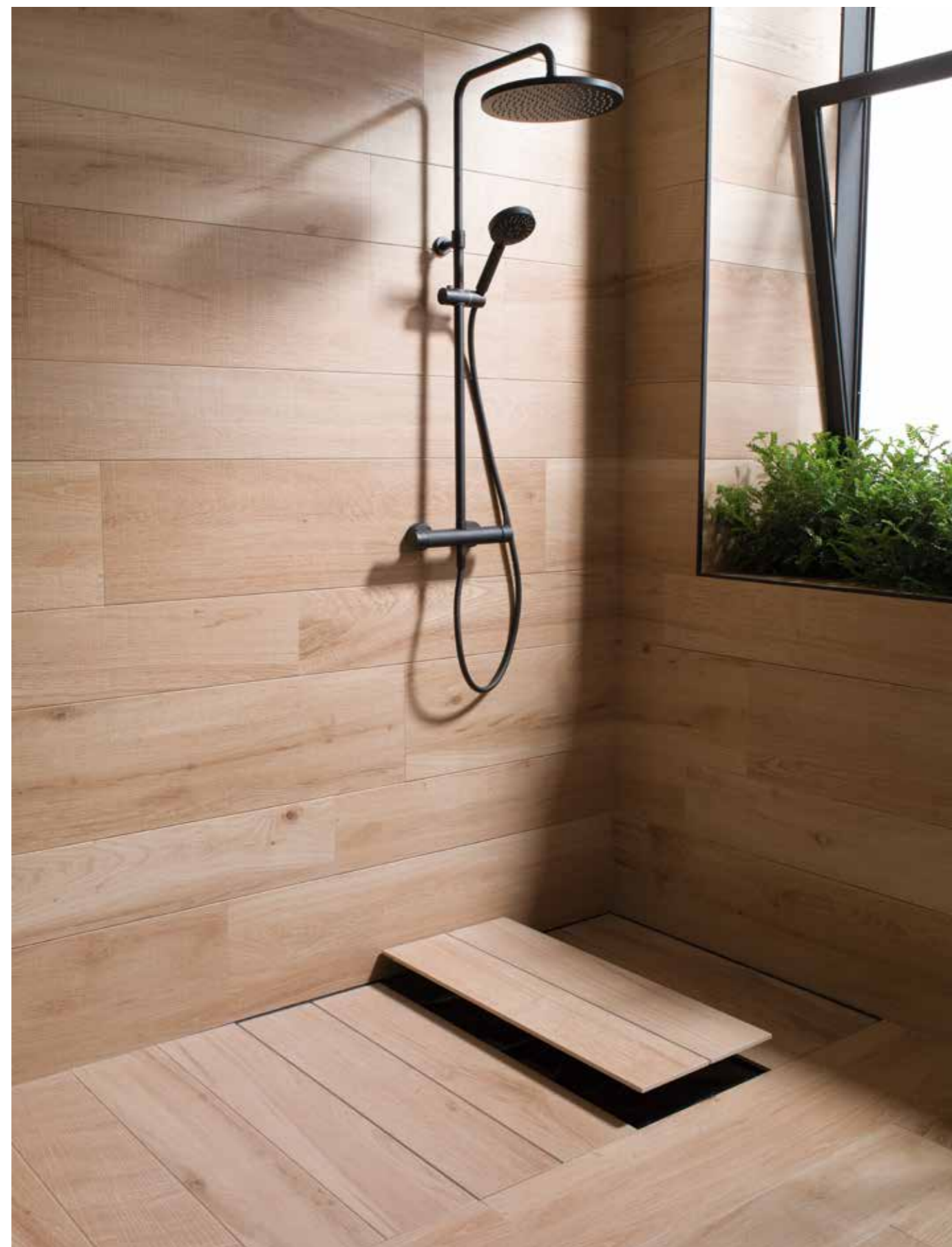

SHOWER TRAYS AND WATERPROOFING

shower deck system

| SAP | | Presentation | P/EU |
|-----------|--------------------|--------------|-------------------|
| 100174849 | 700 x 700 x 30 mm | 1 box | 630.63 p/u |
| 100175270 | 800 x 800 x 30 mm | 1 box | 694.83 p/u |
| 100175271 | 800 x 938 x 30 mm | 1 box | 742.08 p/u |
| 100175268 | 900 x 938 x 30 mm | 1 box | 782.23 p/u |
| 100187136 | 1216 x 938 x 30 mm | 1 box | 909.09 p/u |
| 100174848 | Bespoke* | 1 box | |

drain

| SAP | | P/EU |
|-----------|--|------------------|
| 250045810 | horizontal swd drain | 27.46 p/u |
| 250049540 | vertical horizontal swd drain | 30.64 p/u |
| 250049695 | high flow swd drain + non-retirn valve | 98.75 p/u |

* Maximum shower tray dimensions 1.300 x 3.000 x 30 mm

CONCEPT XPS SHOWER TRAYS

concept xps shower trays

It is a prefabricated system for creating built in shower trays. They include the slopes for the correct water drainage, as well as the drain and the waterproofing system. This system is supplied ready to use, which reduces working times while guarantees a perfect substrate for laying mosaic, natural stone or ceramics.

concept xps shower tray is light, resistant and safe, reason why it is specially recommended in bathroom refurbishing jobs. It includes imperband kit as a drain and waterproofing system, but it does not include the decorative grating, so you can choose among a wide range of sizes, shapes and finishes.

Features:

- Prefabricated shower tray made of extruded polystyrene covered with cement mortar.
- It includes slopes for water drainage.
- Double waterproofing: covering consisting of waterproof mortar and imperband sheet.
- It includes imperband kit for waterproofing the shower tray and the adjustment piece.
- Available in two options:
 - imperband standard kit: 40 mm high
 - imperband refurbishing kit: 30 mm high
- Available for square as well as for linear drains.

- Compression resistance (10% crush risk): DIN 3421 0.3 N / mm²
- Initial thermal conductivity: DIN 2612 0.0336 W/m²K
- Flammability: DIN 4102 B1

Recommended uses:

- Specially designed for waterproofing built in showers.

Materials:

- Absorbent and non-absorbent ceramic tiles. Porcelain tiles with a water absorption < 0.5% as per EN-ISO 10545-3.
- Glass mosaic.
- Natural stone and marble not prone to staining.

Substrates:

- Concrete floor slabs.
- Cement covered floors.

concept shower tray selection guide

1. Depending on the drain outlet, select the type of concept xps shower tray to be used:

- Vertical outlet: Standard tray
- Horizontal outlet: Select depending on the shower tray height.

2. Depending on the shower tray height, select the type of concept xps tray to be used:

- 75–100 mm height Refurbishing shower tray
- > 100 mm height Standard shower tray

3. Select the type of decorative grating:

- Square grating: Shower tray for square grating
- Linear grating: Shower tray for linear grating

4. Select the grating position:

- EQ: Grating on a corner
- CQ/CR/LCQ/LCR: Grating in a central position
- LR/LLQ/LLR: Grating in a lateral position

5. Select the shower tray shape:

- Square shower tray.
- Rectangular shower tray.

6. Choose the shower tray among the available sizes.

In the case that the available sizes do not fit in the project needs, there is the possibility of making custom shower trays.

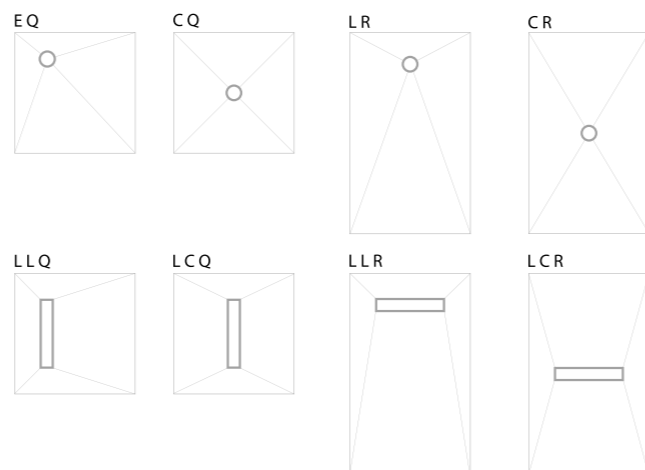

SHOWER TRAYS AND WATERPROOFING

Standard shower trays for square grating

These shower trays feature a 40 mm thickness. It includes the imperband standard kit. Does not include the square grating.

concept xps shower trays



Square shower trays with square corner grating: EQ

| SAP | | Presentation | P/EU |
|-----------|---------------------|-----------------------------|-------------------|
| 100103276 | 900 x 900 x 40 mm | Shower tray + Kit imperband | 389.31 p/u |
| 100103236 | 1000 x 1000 x 40 mm | Shower tray + Kit imperband | 339.73 p/u |

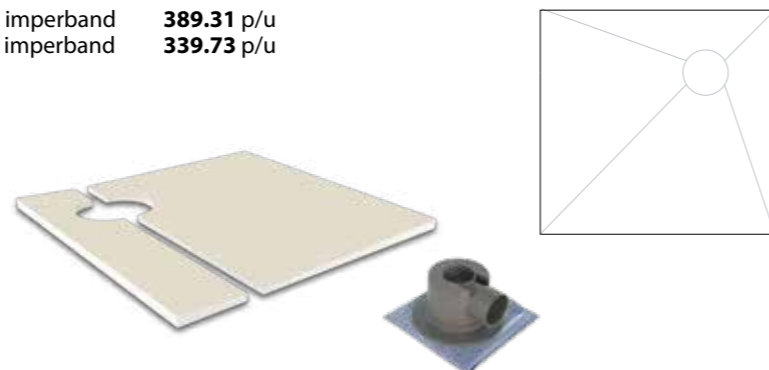

Rectangular shower trays with lateral square grid: LR

| SAP | | Presentation | P/EU |
|-----------|---------------------|-----------------------------|-------------------|
| 100103251 | 900 x 1200 x 40 mm | Shower tray + Kit imperband | 399.42 p/u |
| 100103257 | 900 x 1400 x 40 mm | Shower tray + Kit imperband | 426.22 p/u |
| 100103267 | 900 x 1600 x 40 mm | Shower tray + Kit imperband | 446.51 p/u |
| 100108080 | 900 x 1800 x 40 mm | Shower tray + Kit imperband | 466.76 p/u |
| 100103247 | 1000 x 1200 x 40 mm | Shower tray + Kit imperband | 399.96 p/u |

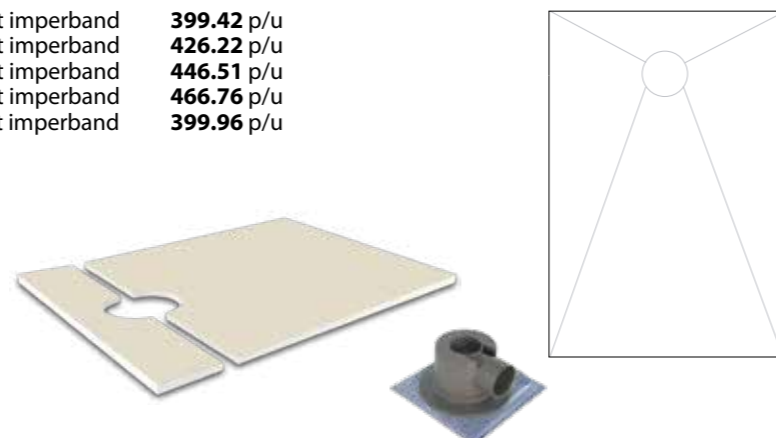

Square gratings

Information referring to squared gratings is on page 187.

| SAP | Square grating |
|-----------|--------------------|
| 100148572 | standard n squared |
| 100114593 | sun |
| 100293010 | square chrome |
| 100293012 | square tile |

All the concept xps shower trays have available a 50 mm thickness special piece to increase the height of the shower tray and cover sewer and drain. Check conditions with your sales representative from PORCELANOSA GRUPO.

Standard shower trays for linear grating

These shower trays feature a 40 mm thickness. It includes the imperband standard kit. Does not include linear gratings.

concept xps shower trays



Square shower trays with lateral linear grating: LCQ

| SAP | | Presentation | P/EU |
|-----------|---------------------|-----------------------------|-------------------|
| 100106439 | 1200 x 1200 x 40 mm | Shower tray + Kit imperband | 448.33 p/u |
| 100114485 | 1500 x 1500 x 40 mm | Shower tray + Kit imperband | 586.95 p/u |

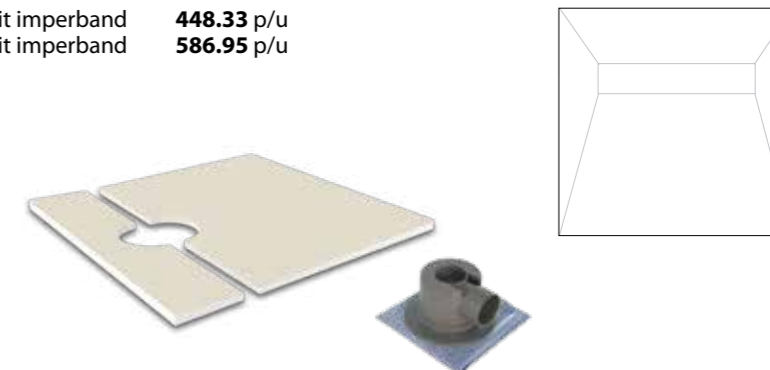

Rectangular shower trays with lateral linear grating: LLR

| SAP | | Presentation | P/EU |
|-----------|---------------------|-----------------------------|-------------------|
| 100105150 | 900 x 1200 x 40 mm | Shower tray + Kit imperband | 420.80 p/u |
| 100106441 | 900 x 1500 x 40 mm | Shower tray + Kit imperband | 454.47 p/u |
| 100114491 | 900 x 1600 x 40 mm | Shower tray + Kit imperband | 467.85 p/u |
| 100108880 | 900 x 1800 x 40 mm | Shower tray + Kit imperband | 490.76 p/u |
| 100106438 | 1000 x 1200 x 40 mm | Shower tray + Kit imperband | 421.31 p/u |

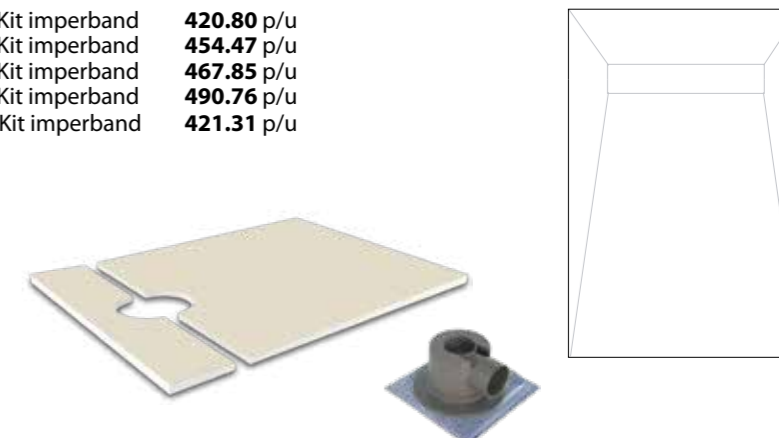

Linear gratings

Information referring to linear gratings is on page 184 - 186.

Select the linear grid depending on the shower tray width, so that the minimum distance between the grid and the concept xps shower tray sides exceeds 100 mm on both sides. We recommend to follow the instructions given in the table below:

| Grid length: | Shower tray width: |
|---------------|--------------------|
| 59,6 x 9,3 cm | > 800 mm |
| 80 x 9,3 cm | > 1000 mm |
| 120 x 9,3 cm | > 1400 mm |

All the concept xps shower trays have available a 50 mm thickness special piece to increase the height of the shower tray and cover sewer and drain. Check conditions with your sales representative from PORCELANOSA GRUPO.

Refurbishing shower trays for square grating

These shower trays feature a 30 mm thickness. It includes the imperband refurbishing kit. Does not include the square grating.

concept xps shower trays



Square shower trays with square corner grating: EQ

| SAP | | Presentation | P/EU |
|-----------|---------------------|-----------------------------|-------------------|
| 100103297 | 900 x 900 x 30 mm | Shower tray + Kit imperband | 414.51 p/u |
| 100103282 | 1000 x 1000 x 30 mm | Shower tray + Kit imperband | 422.29 p/u |
| 100103295 | 1200 x 1200 x 30 mm | Shower tray + Kit imperband | 452.15 p/u |

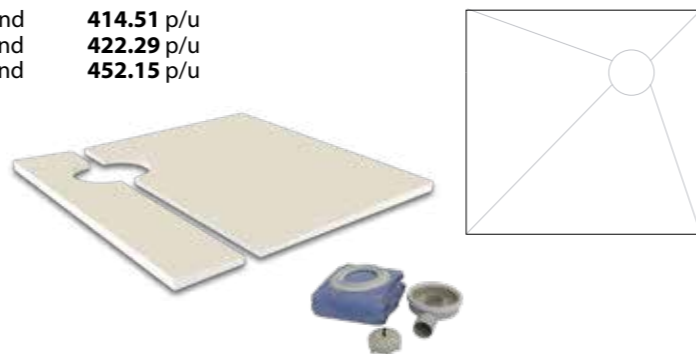

Rectangular shower trays with lateral square grid: LR

| SAP | | Presentation | P/EU |
|-----------|---------------------|-----------------------------|-------------------|
| 100103300 | 900 x 1200 x 30 mm | Shower tray + Kit imperband | 424.62 p/u |
| 100103314 | 900 x 1500 x 30 mm | Shower tray + Kit imperband | 458.33 p/u |
| 100103293 | 1000 x 1200 x 30 mm | Shower tray + Kit imperband | 425.16 p/u |

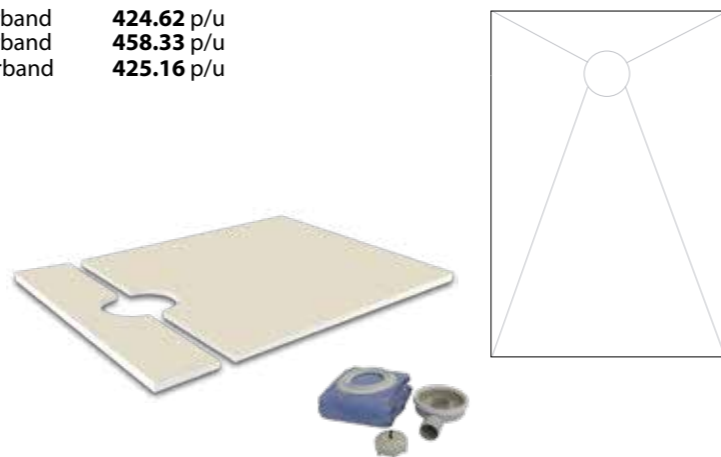

Square gratings

Information referring to squared gratings is on page 187.

| SAP | Square grating |
|-----------|--------------------|
| 100148572 | standard n squared |
| 100114593 | sun |
| 100293010 | square chrome |
| 100293012 | square tile |

All the concept xps shower trays have available a 50 mm thickness special piece to increase the height of the shower tray and cover sewer and drain. Check conditions with your sales representative from PORCELANOSA GRUPO.

Refurbishing shower trays for linear grating

These shower trays feature a 30 mm thickness. It includes the imperband refurbishing kit. Does not include linear gratings.

concept xps shower trays



Square shower trays with lateral linear grating: LLQ

| SAP | | Presentation | P/EU |
|-----------|---------------------|-----------------------------|-------------------|
| 100114466 | 1000 x 1000 x 30 mm | Shower tray + Kit imperband | 443.64 p/u |
| 100114476 | 1200 x 1200 x 30 mm | Shower tray + Kit imperband | 473.53 p/u |

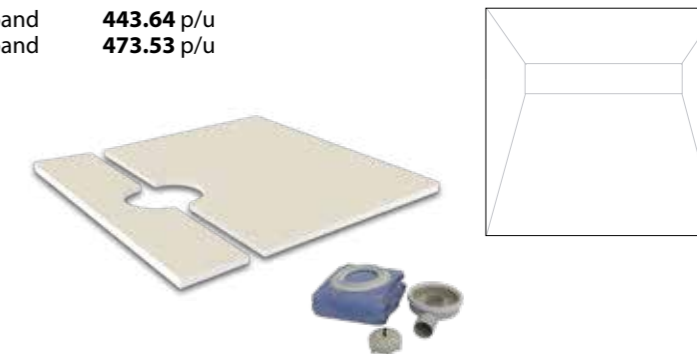

Rectangular shower trays with lateral linear grating: LLR

| SAP | | Presentation | P/EU |
|-----------|---------------------|-----------------------------|-------------------|
| 100114471 | 900 x 1000 x 30 mm | Shower tray + Kit imperband | 446.00 p/u |
| 100111299 | 900 x 1200 x 30 mm | Shower tray + Kit imperband | 446.00 p/u |
| 100114473 | 1000 x 1200 x 30 mm | Shower tray + Kit imperband | 446.51 p/u |
| 100114481 | 1400 x 900 x 30 mm | Shower tray + Kit imperband | 472.80 p/u |
| 100114487 | 900 x 1500 x 30 mm | Shower tray + Kit imperband | 479.67 p/u |
| 100114464 | 900 x 1600 x 30 mm | Shower tray + Kit imperband | 493.05 p/u |
| 100110584 | 900 x 1800 x 30 mm | Shower tray + Kit imperband | 513.35 p/u |

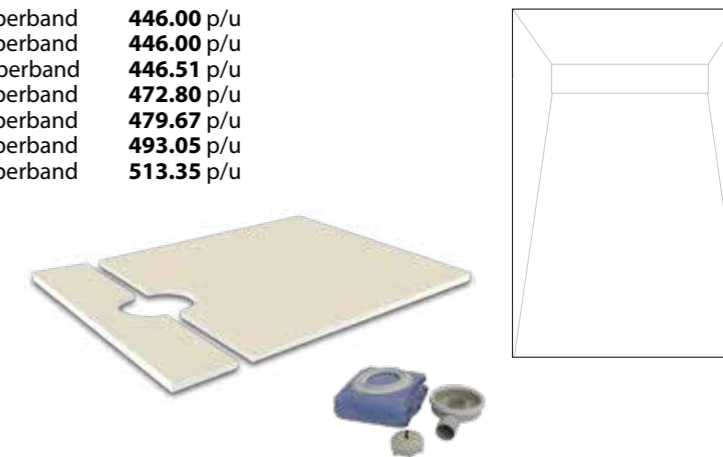

Linear gratings

Information referring to linear gratings is on page 184 - 186.

Select the linear grid depending on the shower tray width, so that the minimum distance between the grid and the concept xps shower tray sides exceeds 100 mm on both sides. We recommend to follow the instructions given in the table below:

| Grid length: | Shower tray width: |
|---------------|--------------------|
| 59,6 x 9,3 cm | > 800 mm |
| 80 x 9,3 cm | > 1000 mm |
| 120 x 9,3 cm | > 1400 mm |

All the concept xps shower trays have available a 50 mm thickness special piece to increase the height of the shower tray and cover sewer and drain. Check conditions with your sales representative from PORCELANOSA GRUPO.



Bespoke shower trays

If you need a shower tray with certain dimensions or shape that cannot be found in our standard shower trays range, butech can make the shower tray with the shape and dimensions you need.

Just send us a drawing with the dimensions and shape you want for your shower tray and we will give you a price and a delivery date. If you agree, we will make your custom shower tray.

For making a square or rectangular shower tray, we need the following information:

- Shower tray dimensions
 - Long side xP
 - Wide side yP
 - Thickness choose among 30/40 mm
- Grating type
 - Square grating
 - Linear grating choose among 59.6/80/120 mm
- Drain position
 - Long side xS
 - Wide side yS

All dimensions must be entered in millimeters.

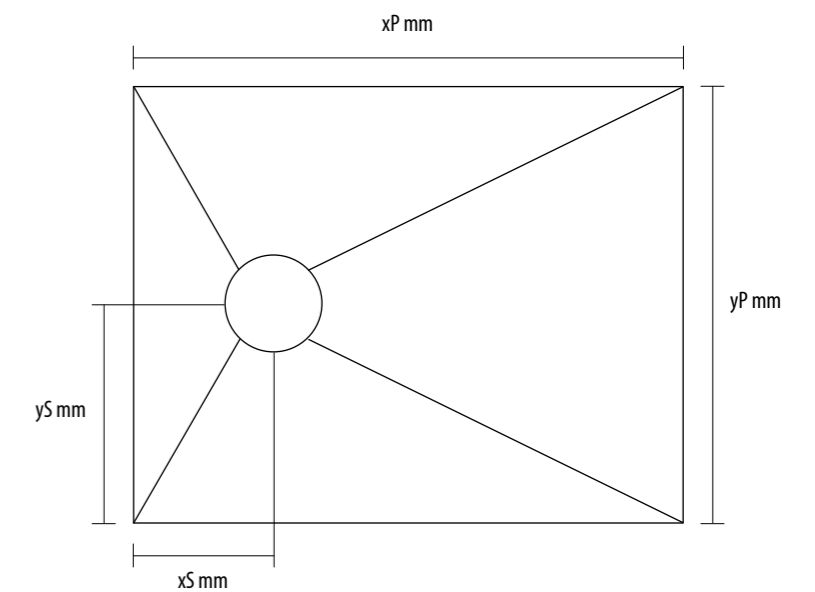

All custom drains include the imperband kit corresponding to the thickness of the chosen board.

Decorative grating is not included. Refer to page 184 - 187.

All the custom concept xps shower trays have available a 50 mm thickness special piece to increase the height of the shower tray and cover sewer and drain. Check conditions with your sales representative from PORCELANOSA GRUPO.

In case you need a shower tray with a non orthogonal shape, check with butech sales department.

Bespoke standard shower trays

These shower trays feature a 40 mm thickness. It includes the imperband standard kit. Does not include square gratings.

concept xps shower trays



Square shower trays with square corner grating: EQ

| SAP | | Presentation | P/EU |
|-----------|----------------------------|-----------------------------|-------------------|
| 100103244 | 1-1000 x < 1000 x 40 mm | Shower tray + Kit imperband | 462.40 p/u |
| 100103240 | 1001-1200 x < 1200 x 40 mm | Shower tray + Kit imperband | 542.62 p/u |
| 100103254 | 1201-1400 x < 1400 x 40 mm | Shower tray + Kit imperband | 623.20 p/u |
| 100103260 | 1401-1600 x < 1600 x 40 mm | Shower tray + Kit imperband | 704.07 p/u |

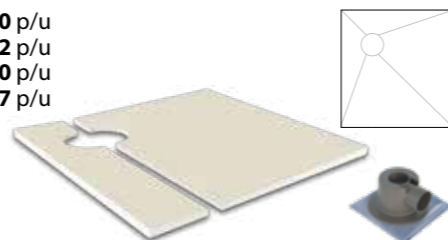

Square shower trays with central square grating: CQ

| SAP | | Presentation | P/EU |
|-----------|----------------------------|-----------------------------|-------------------|
| 100103242 | 1-1000 x < 1000 x 40 mm | Shower tray + Kit imperband | 462.40 p/u |
| 100103238 | 1001-1200 x < 1200 x 40 mm | Shower tray + Kit imperband | 542.62 p/u |
| 100103252 | 1201-1400 x < 1400 x 40 mm | Shower tray + Kit imperband | 623.20 p/u |
| 100103258 | 1401-1600 x < 1600 x 40 mm | Shower tray + Kit imperband | 704.07 p/u |

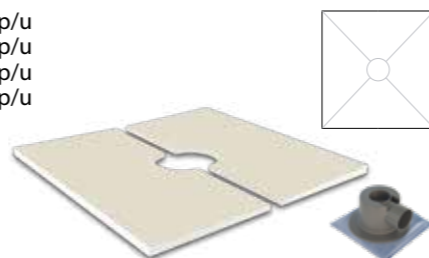

Rectangular shower trays with square lateral grating: LR

| SAP | | Presentation | P/EU |
|-----------|---------------------------|-----------------------------|-------------------|
| 100103245 | 1-1000 x < 901 x 40 mm | Shower tray + Kit imperband | 464.84 p/u |
| 100103241 | 1001-1200 x < 901 x 40 mm | Shower tray + Kit imperband | 397.84 p/u |
| 100103255 | 1201-1400 x < 901 x 40 mm | Shower tray + Kit imperband | 626.62 p/u |
| 100103261 | 1401-1600 x < 901 x 40 mm | Shower tray + Kit imperband | 708.00 p/u |
| 100103268 | 1601-1800 x < 901 x 40 mm | Shower tray + Kit imperband | 789.75 p/u |

The maximum length of the wide side of this type of tray is 900 mm. For higher lengths, check with butech sales department.

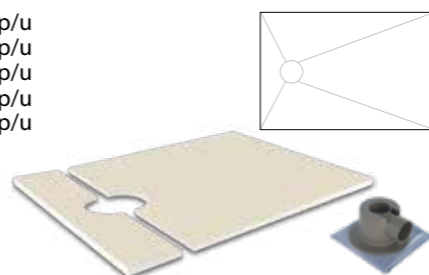

Rectangular shower trays with central square grating: CR

| SAP | | Presentation | P/EU |
|-----------|---------------------------|-----------------------------|-------------------|
| 100103243 | 1-1000 x < 901 x 40 mm | Shower tray + Kit imperband | 464.84 p/u |
| 100103239 | 1001-1200 x < 901 x 40 mm | Shower tray + Kit imperband | 466.69 p/u |
| 100103253 | 1201-1400 x < 901 x 40 mm | Shower tray + Kit imperband | 626.62 p/u |
| 100103259 | 1401-1600 x < 901 x 40 mm | Shower tray + Kit imperband | 708.00 p/u |
| 100103269 | 1601-1800 x < 901 x 40 mm | Shower tray + Kit imperband | 789.75 p/u |
| 100103271 | 1801-2000 x < 901 x 40 mm | Shower tray + Kit imperband | 871.78 p/u |
| 100103273 | 2001-2200 x < 901 x 50 mm | Shower tray + Kit imperband | 954.18 p/u |

The maximum length of the wide side of this type of tray is 900 mm. For higher lengths, check with butech sales department.



All the concept xps shower trays have available a 50 mm thickness special piece to increase the height of the shower tray and cover sewer and drain. Check conditions with your sales representative from PORCELANOSA GRUPO.

Information referring to squared gratings is on page 187.

Bespoke standard shower trays for linear grating

These shower trays feature a 40 mm thickness. It includes the imperband standard kit. Does not include linear gratings.

concept xps shower trays



Square shower trays with lateral linear grating: LLQ

| SAP | | Presentation | P/EU |
|-----------|----------------------------|-----------------------------|-------------------|
| 100116102 | 1-1000 x < 1000 x 40 mm | Shower tray + Kit imperband | 483.75 p/u |
| 100116110 | 1001-1200 x < 1200 x 40 mm | Shower tray + Kit imperband | 564.00 p/u |
| 100116118 | 1201-1400 x < 1400 x 40 mm | Shower tray + Kit imperband | 644.55 p/u |
| 100116126 | 1401-1600 x < 1600 x 40 mm | Shower tray + Kit imperband | 725.45 p/u |

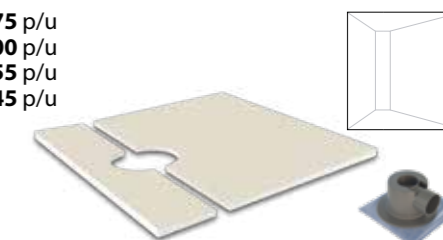

Square shower trays with central linear grating: LCQ

| SAP | | Presentation | P/EU |
|-----------|----------------------------|-----------------------------|-------------------|
| 100116100 | 1-1000 x < 1000 x 40 mm | Shower tray + Kit imperband | 483.75 p/u |
| 100116108 | 1001-1200 x < 1200 x 40 mm | Shower tray + Kit imperband | 564.00 p/u |
| 100116116 | 1201-1400 x < 1400 x 40 mm | Shower tray + Kit imperband | 644.55 p/u |
| 100116124 | 1401-1600 x < 1600 x 40 mm | Shower tray + Kit imperband | 725.45 p/u |

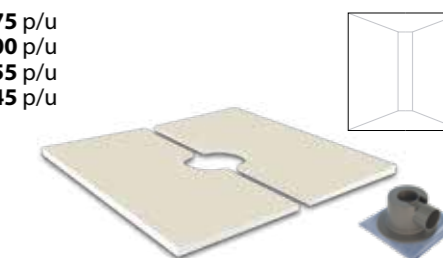

Rectangular shower trays with linear side grating: LLR

| SAP | | Presentation | P/EU |
|-----------|---------------------------|-----------------------------|-------------------|
| 100116103 | 1-1000 x < 901 x 40 mm | Shower tray + Kit imperband | 486.22 p/u |
| 100116111 | 1001-1200 x < 901 x 40 mm | Shower tray + Kit imperband | 488.07 p/u |
| 100116119 | 1201-1400 x < 901 x 40 mm | Shower tray + Kit imperband | 648.00 p/u |
| 100110295 | 1401-1600 x < 901 x 40 mm | Shower tray + Kit imperband | 729.38 p/u |
| 100110164 | 1601-1800 x < 901 x 40 mm | Shower tray + Kit imperband | 811.09 p/u |
| 100116136 | 1801-2000 x < 901 x 40 mm | Shower tray + Kit imperband | 893.13 p/u |
| 100116140 | 2001-2200 x < 901 x 50 mm | Shower tray + Kit imperband | 975.53 p/u |

The maximum length of the wide side of this type of tray is 900 mm. For higher lengths, check with butech sales department.

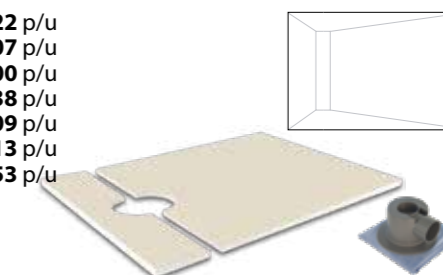

Rectangular shower trays with central linear grating: LCR

| SAP | | Presentation | P/EU |
|-----------|---------------------------|-----------------------------|-------------------|
| 100116101 | 1-1000 x < 901 x 40 mm | Shower tray + Kit imperband | 486.22 p/u |
| 100116109 | 1001-1200 x < 901 x 40 mm | Shower tray + Kit imperband | 488.07 p/u |
| 100116117 | 1201-1400 x < 901 x 40 mm | Shower tray + Kit imperband | 648.00 p/u |
| 100116125 | 1401-1600 x < 901 x 40 mm | Shower tray + Kit imperband | 729.38 p/u |
| 100116131 | 1601-1800 x < 901 x 40 mm | Shower tray + Kit imperband | 811.09 p/u |
| 100116135 | 1801-2000 x < 901 x 40 mm | Shower tray + Kit imperband | 893.13 p/u |
| 100116139 | 2001-2200 x < 901 x 50 mm | Shower tray + Kit imperband | 975.53 p/u |

The maximum length of the wide side of this type of tray is 900 mm. For higher lengths, check with butech sales department.



All the concept xps shower trays have available a 50 mm thickness special piece to increase the height of the shower tray and cover sewer and drain. Check conditions with your sales representative from PORCELANOSA GRUPO.

Information referring to linear gratings is on page 184 - 186.

Bespoke refurbishing shower trays

These shower trays feature a 30 mm thickness. It includes the imperband refurbishing kit. Does not include squaregratings.

concept xps shower trays



Square shower trays with square corner grating: EQ

| SAP | | Presentation | P/EU |
|-----------|----------------------------|-----------------------------|-------------------|
| 100103290 | 1-1000 x < 1000 x 30 mm | Shower tray + Kit imperband | 487.60 p/u |
| 100103286 | 1001-1200 x < 1200 x 30 mm | Shower tray + Kit imperband | 567.82 p/u |
| 100103303 | 1201-1400 x < 1400 x 30 mm | Shower tray + Kit imperband | 648.40 p/u |
| 100103309 | 1401-1600 x < 1600 x 30 mm | Shower tray + Kit imperband | 729.27 p/u |

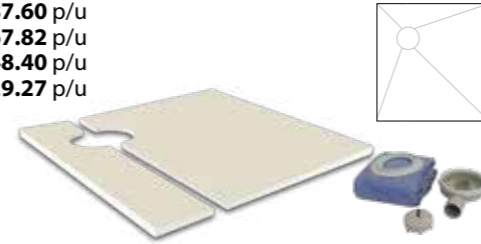

Square shower trays with central square grating: CQ

| SAP | | Presentation | P/EU |
|-----------|----------------------------|-----------------------------|-------------------|
| 100103288 | 1-1000 x < 1000 x 30 mm | Shower tray + Kit imperband | 487.60 p/u |
| 100103284 | 1001-1200 x < 1200 x 30 mm | Shower tray + Kit imperband | 567.82 p/u |
| 100103301 | 1201-1400 x < 1400 x 30 mm | Shower tray + Kit imperband | 648.40 p/u |
| 100103307 | 1401-1600 x < 1600 x 30 mm | Shower tray + Kit imperband | 648.40 p/u |

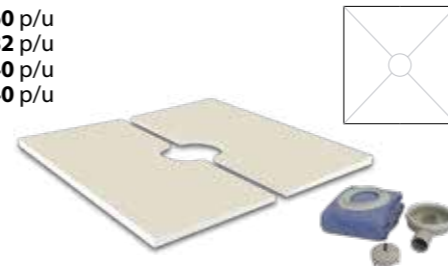

Rectangular shower trays with square lateral grating: LR

| SAP | | Presentation | P/EU |
|-----------|---------------------------|-----------------------------|-------------------|
| 100103291 | 1-1000 x < 901 x 30 mm | Shower tray + Kit imperband | 490.04 p/u |
| 100103287 | 1001-1200 x < 901 x 30 mm | Shower tray + Kit imperband | 491.89 p/u |
| 100103304 | 1201-1400 x < 901 x 30 mm | Shower tray + Kit imperband | 572.36 p/u |
| 100103310 | 1401-1600 x < 901 x 30 mm | Shower tray + Kit imperband | 733.20 p/u |
| 100103317 | 1601-1800 x < 901 x 30 mm | Shower tray + Kit imperband | 814.95 p/u |

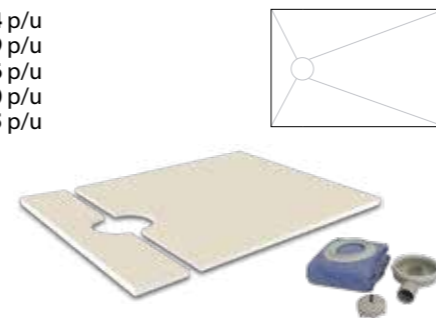

The maximum length of the wide side of this type of tray is 900 mm. For higher lengths, check with butech sales department.

Rectangular shower trays with central square grating: CR

| SAP | | Presentation | P/EU |
|-----------|---------------------------|-----------------------------|-------------------|
| 100103289 | 1-1000 x < 901 x 30 mm | Shower tray + Kit imperband | 490.04 p/u |
| 100103285 | 1001-1200 x < 901 x 30 mm | Shower tray + Kit imperband | 491.89 p/u |
| 100103302 | 1201-1400 x < 901 x 30 mm | Shower tray + Kit imperband | 651.82 p/u |
| 100103308 | 1401-1600 x < 901 x 30 mm | Shower tray + Kit imperband | 733.20 p/u |
| 100103318 | 1601-1800 x < 901 x 30 mm | Shower tray + Kit imperband | 814.95 p/u |
| 100103320 | 1801-2000 x < 901 x 30 mm | Shower tray + Kit imperband | 896.98 p/u |
| 100103322 | 2001-2200 x < 901 x 50 mm | Shower tray + Kit imperband | 979.38 p/u |

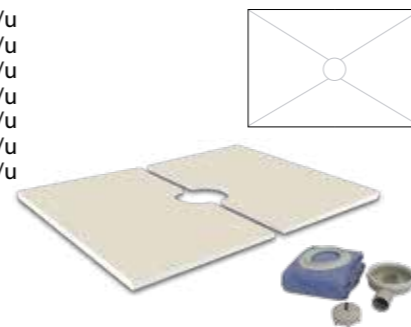

The maximum length of the wide side of this type of tray is 900 mm. For higher lengths, check with butech sales department.

All the concept xps shower trays have available a 50 mm thickness special piece to increase the height of the shower tray and cover sewer and drain. Check conditions with your sales representative from PORCELANOSA GRUPO.

Information referring to squared gratings is on page 187.

Bespoke refurbishing shower trays for linear grating

These shower trays feature a 30 mm thickness. It includes the imperband refurbishing kit. Does not include linear gratings.

concept xps shower trays



Square shower trays with lateral linear grating: LLQ

| SAP | | Presentation | P/EU |
|-----------|----------------------------|-----------------------------|-------------------|
| 100116098 | 1-1000 x < 1000 x 30 mm | Shower tray + Kit imperband | 508.95 p/u |
| 100116106 | 1001-1200 x < 1200 x 30 mm | Shower tray + Kit imperband | 589.20 p/u |
| 100116114 | 1201-1400 x < 1400 x 30 mm | Shower tray + Kit imperband | 669.75 p/u |
| 100116122 | 1401-1600 x < 1600 x 30 mm | Shower tray + Kit imperband | 750.65 p/u |

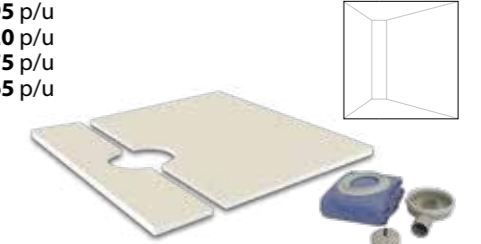

Square shower trays with central linear grating: LCQ

| SAP | | Presentation | P/EU |
|-----------|----------------------------|-----------------------------|-------------------|
| 100116096 | 1-1000 x < 1000 x 30 mm | Shower tray + Kit imperband | 508.95 p/u |
| 100116104 | 1001-1200 x < 1200 x 30 mm | Shower tray + Kit imperband | 589.20 p/u |
| 100116112 | 1201-1400 x < 1400 x 30 mm | Shower tray + Kit imperband | 669.75 p/u |
| 100116120 | 1401-1600 x < 1600 x 30 mm | Shower tray + Kit imperband | 750.65 p/u |

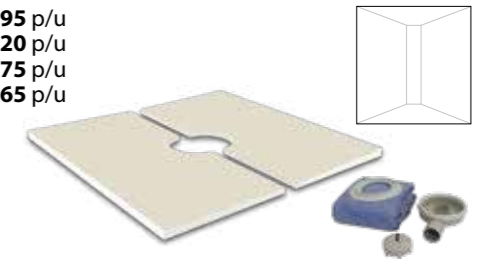

Rectangular shower trays with linear side grating: LLR

| SAP | | Presentation | P/EU |
|-----------|---------------------------|-----------------------------|--------------------|
| 100116099 | 1-1000 x < 901 x 30 mm | Shower tray + Kit imperband | 511.42 p/u |
| 100116107 | 1001-1200 x < 901 x 30 mm | Shower tray + Kit imperband | 513.27 p/u |
| 100116115 | 1201-1400 x < 901 x 30 mm | Shower tray + Kit imperband | 673.20 p/u |
| 100116123 | 1401-1600 x < 901 x 30 mm | Shower tray + Kit imperband | 754.58 p/u |
| 100116130 | 1601-1800 x < 901 x 30 mm | Shower tray + Kit imperband | 836.29 p/u |
| 100116134 | 1801-2000 x < 901 x 30 mm | Shower tray + Kit imperband | 918.33 p/u |
| 100116138 | 2001-2200 x < 901 x 50 mm | Shower tray + Kit imperband | 1000.73 p/u |

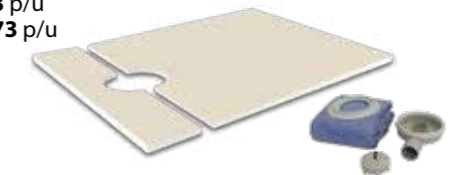

The maximum length of the wide side of this type of tray is 900 mm. For higher lengths, check with butech sales department.

Rectangular shower trays with central linear grating: LCR

| SAP | | Presentation | P/EU |
|-----------|---------------------------|-----------------------------|--------------------|
| 100116097 | 1-1000 x < 901 x 30 mm | Shower tray + Kit imperband | 511.42 p/u |
| 100116105 | 1001-1200 x < 901 x 30 mm | Shower tray + Kit imperband | 513.27 p/u |
| 100116113 | 1201-1400 x < 901 x 30 mm | Shower tray + Kit imperband | 673.20 p/u |
| 100116121 | 1401-1600 x < 901 x 30 mm | Shower tray + Kit imperband | 729.38 p/u |
| 100116129 | 1601-1800 x < 901 x 30 mm | Shower tray + Kit imperband | 836.29 p/u |
| 100116133 | 1801-2000 x < 901 x 30 mm | Shower tray + Kit imperband | 918.33 p/u |
| 100116137 | 2001-2200 x < 901 x 50 mm | Shower tray + Kit imperband | 1000.73 p/u |

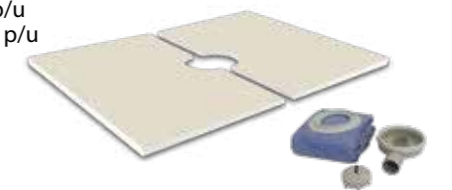

The maximum length of the wide side of this type of tray is 900 mm. For higher lengths, check with butech sales department.

All the concept xps shower trays have available a 50 mm thickness special piece to increase the height of the shower tray and cover sewer and drain. Check conditions with your sales representative from PORCELANOSA GRUPO.

Information referring to linear gratings is on page 184 - 186.

Panel concept xps

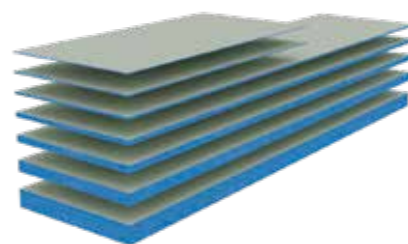
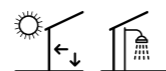

concept xps panels are extruded polystyrene panels ready for laying wall tiles, mosaics or natural stone with cement-based adhesives. Polystyrene lightness and easy handling, as well as its mechanical resistance and damp resistance make of this panel the perfect substrate for all kinds of environments where damp is present.

This kind of panel is available in thicknesses ranging from 4 to 80 mm and also in special precut boards that allow for a fast installation of curved shapes.

Features:

- Extruded polystyrene boards covered on both sides with waterproof cement mortar.
- Non-absorbent material. Its structure prevents water buildup. Resistant to dampness.
- Excellent surface for laying rectified tiles.
- Low thermal conductivity coefficient.
- Good soundproofing against impact noise.
- Easy handling and transport.
- Quick and clean installation.
- Resistant to microorganism attack.
- Inert and non-hazardous material made with 50% to 70% recycled material.
- Fire resistant: B1 as per DIN 4102.

Substrates:

- Usual indoor substrates in the building industry.
- Uncovered brick partition walls.
- Concrete floor slabs.
- Existing wall and floor tiles.
- Self-supporting indoors. Only 50 and 80 mm boards.

Recommended uses:

- Preparation of substrates for ceramic tiles laying. Specially recommended in refurbishing jobs.
- Bathroom countertops and vanities in permanently wet areas.
- Bathroom partition walls and platforms.
- Bathtub skirts and shower cabins.
- Shelves and panels attached to partition walls.
- Health resorts, saunas and spa premises.
- Thermal insulation of electric radiant heating floors.

Materials:

- Absorbent and non-absorbent ceramic tiles. Porcelain tiles with a water absorption < 0.5% as per EN-ISO 10545-3.
- Glass mosaic.
- Natural stone and marble not prone to staining.

Fixing elements for concept xps panels

concept fastening

| SAP | | Presentation | P/EU |
|-----------|--------------------------|--------------|--------------------|
| 100067686 | 45 mm metal fastening | 50 ud/bag | 48.33 p/bag |
| 100062773 | 130 mm plastic fastening | 10 ud/bag | 11.00 p/bag |
| 100062774 | 130 mm plastic fastening | 50 ud/bag | 51.05 p/bag |
| 100062775 | 80 mm plastic fastening | 10 ud/bag | 8.11 p/bag |
| 100062776 | 80 mm plastic fastening | 50 ud/bag | 34.69 p/bag |



Self-adhesive fiberglass mesh roll

| SAP | | Presentation | P/EU |
|-----------|-------------------------------|--------------|---------------------|
| 100062825 | self-adhesive fiberglass mesh | Roll 10 m | 11.17 p/roll |
| 100062826 | self-adhesive fiberglass mesh | Roll 20 m | 19.26 p/roll |



Polyurethane putty

| SAP | | Presentation | P/EU |
|-----------|----------------|--------------|------------------|
| 100292915 | h-920 | 290 ml | 11.89 p/u |
| 100031189 | super-one gris | 25kg | 1.32 p/kg |



Technical features

| PROPERTIES | STANDARD | VALUE |
|-------------------------------------|------------|---|
| Compression resistance (10% strain) | DIN 53421 | 300 KN/m ² |
| Nominal density | EN 1602 | 35 Kg/m ³ |
| Shear resistance | EN 12090 | 0,25 N/mm ² |
| Tensile strength | EN 1607 | 0,50 N/mm ² |
| Adherence of the protection | | > 2,0 Kg/cm ² |
| Resistance to eccentric load | | > 10,0 Kg/cm ² |
| Water absorption | | < 1,0 Kg/m ² |
| Thermal conductivity | EN 13164 | 0,034 W/m.k (30-60 mm) 0,036 W/m.k (> 60 mm) |
| Working temperature range | | -50 °C / +75 °C |
| Tolerances | | Length: +/- 5 mm Width: +/- 3 mm Thickness: +/- 2 mm Squareness: < 2 mm/m.l. |
| Fire resistance | DIN 4102-1 | B s1-d0 |

concept xps panels

| SAP | | ud./pallet | P/EU |
|-----------|------------------|------------|-------------------|
| 100103351 | 4 mm 1250 x 600 | 300 | 24.62 p/u |
| 100103352 | 6 mm 1250 x 600 | 280 | 23.72 p/u |
| 100103349 | 10 mm 2500 x 600 | 225 | 51.62 p/u |
| 100103350 | 20 mm 2500 x 600 | 111 | 55.65 p/u |
| 100103354 | 30 mm 2500 x 600 | 80 | 62.80 p/u |
| 100103355 | 50 mm 2500 x 600 | 45 | 72.60 p/u |
| 100103356 | 80 mm 2500 x 600 | 31 | 113.53 p/u |

imperband standard kit



The **standard imperband kit** is an indoor waterproofing system consisting of a PVC gutter thermowelded to a 150 x 225 cm waterproof sheet. Specially recommended for waterproofing shower trays in new building works. Residential use.

The waterproof sheet is an imperband type 0,5 mm thick polymer membrane with a double thermoplastic polyolefin sheet and covered on both sides by non woven polyester fibers that allow it to be bonded to surfaces using cement-based adhesives. The gutter features a compact design and multiple possibilities of outlet connections.

It does not include neither the grate nor the drain frame.



Features:

- Maximum security, it eliminates leakage risks between waterproof sheet and drain piece.
- 150 x 225 cm waterproof sheet.
- Discharge speed. 0.6 l/s.
- Compact system, just 100 mm high.
- Adaptable to horizontal and vertical outlets. Adjustable outlet diameter: 40/50 mm.
- Includes u-bend.
- Direct installation of the tile on the waterproof sheet.
- Quick and easy application.

Recommended use:

- Specially designed for waterproofing built in showers.

Materials:

- Absorbent and non-absorbent ceramic tiles. Porcelain tiles with a water absorption < 0.5% as per EN-ISO 10545-3.
- Glass mosaic.
- Natural stone.

Substrates:

- Cement covered floors.
- Specially designed for Concept XPS shower trays, prefabricated polystyrene panels.

Installation:

- Depending on the drainage pipe position, select one of the system outlets and seal the other outlet with the cap provided to that effect.
- Given the case, use the drain outlet diameter adapter and glue the drainage pipe.
- Before laying the ceramics of the shower tray, check that the gutter works correctly.
- Use the waterproof sheet in the same way as the imperband sheet.

imperband standard kit

| SAP | Presentation | P/EU |
|-----------|--------------------------|------------|
| 100103360 | Kit 150 x 225 cm 1ud/box | 102.22 p/u |

Before using this product in any application not indicated in this catalogue, please perform a test or refer to the product's technical sheet.

imperband refurbishing kit n



The **imperband refurbishing kit n** is an indoor waterproofing system consisting of an extrathin PVC gutter thermowelded to a 150 x 225 cm waterproof sheet. Specially recommended for waterproofing shower trays in refurbishing jobs. Residential use.

The waterproof sheet is an imperband type 0.5 mm thick polymer membrane with a double thermoplastic polyolefin sheet and covered on both sides by non woven polyester fibers that allow it to be bonded to surfaces using cement-based adhesives. The only 65 mm drain height allows to carry out installations of 75 mm from the substrate to the ceramic wall covering.

It does not include neither the grate nor the drain frame.



Features:

- Maximum security, it eliminates leakage risks between waterproof sheet and drain piece.
- 150 x 225 cm waterproof sheet.
- Discharge speed. 0.5 l/s.
- Very compact system, just 75 mm high.
- 50 mm diameter horizontal outlet.
- Includes u-bend.
- Direct installation of the tile on the waterproof sheet.
- Quick and easy application.

Recommended use:

- Specially designed for waterproofing showers in refurbishing jobs.

Materials:

- Absorbent and non-absorbent ceramic tiles. Porcelain tiles with a water absorption < 0.5% as per EN-ISO 10545-3.
- Glass mosaic.
- Natural stone.

Substrates:

- Cement covered floors.
- Specially designed for Concept XPS shower trays, prefabricated polystyrene panels.

Installation:

- Connect the imperband refurbishing kit n and check that the gutter works correctly.
- Use the waterproof sheet in the same way as the imperband sheet.

imperband refurbishing kit n

| SAP | Presentation | P/EU |
|-----------|--------------------------|------------|
| 100187047 | Kit 150 x 225 cm 1ud/box | 128.31 p/u |

Before using this product in any application not indicated in this catalogue, please perform a test or refer to the product's technical sheet.

linear grates



| glass white | | | |
|-------------|-------------|--------------|-------------------|
| SAP | | Presentation | P/EU |
| 100141156 | 93 x 596 mm | 1ud/box | 411.24 p/u |



| glass black | | | |
|-------------|-------------|--------------|-------------------|
| SAP | | Presentation | P/EU |
| 100141153 | 93 x 596 mm | 1ud/box | 411.24 p/u |



| ceramic framed | | | |
|----------------|--------------|--------------|-------------------|
| SAP | | Presentation | P/EU |
| 100148593 | 93 x 596 mm | 1ud/box | 342.99 p/u |
| 100148595 | 93 x 800 mm | 1ud/box | 456.74 p/u |
| 100148594 | 93 x 1200 mm | 1ud/box | 619.41 p/u |



Includes drainage channel and grate.

Before using this product in any application not indicated in this catalogue, please perform a test or refer to the product's technical sheet.

linear grates



| black | | | |
|-----------|-------------|--------------|-------------------|
| SAP | | Presentation | P/EU |
| 100278946 | 93 x 596 mm | 1ud/box | 576.64 p/u |



| chrome | | | |
|-----------|--------------|--------------|-------------------|
| SAP | | Presentation | P/EU |
| 100103365 | 93 x 596 mm | 1ud/box | 338.72 p/u |
| 100103366 | 93 x 800 mm | 1ud/box | 444.25 p/u |
| 100103364 | 93 x 1200 mm | 1ud/box | 634.52 p/u |



| texture | | | |
|-----------|--------------|--------------|-------------------|
| SAP | | Presentation | P/EU |
| 100103368 | 93 x 596 mm | 1ud/box | 322.80 p/u |
| 100103369 | 93 x 800 mm | 1ud/box | 440.12 p/u |
| 100103367 | 93 x 1200 mm | 1ud/box | 609.17 p/u |



Includes drainage channel and grate.

Before using this product in any application not indicated in this catalogue, please perform a test or refer to the product's technical sheet.



| squared | | | |
|-----------|--------------|--------------|-------------------|
| SAP | | Presentation | P/EU |
| 100103371 | 93 x 596 mm | 1ud/box | 305.20 p/u |
| 100103372 | 93 x 800 mm | 1ud/box | 405.46 p/u |
| 100103370 | 93 x 1200 mm | 1ud/box | 554.08 p/u |



| line | | | |
|-----------|--------------|--------------|-------------------|
| SAP | | Presentation | P/EU |
| 100103374 | 93 x 596 mm | 1ud/box | 299.43 p/u |
| 100103375 | 93 x 800 mm | 1ud/box | 405.46 p/u |
| 100103373 | 93 x 1200 mm | 1ud/box | 554.08 p/u |

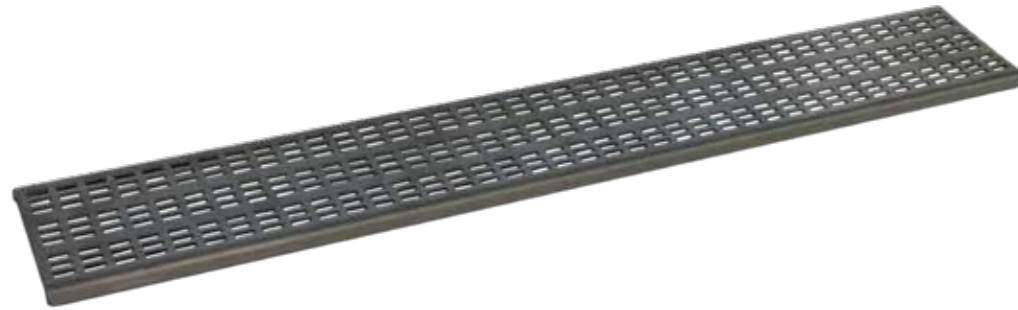

Includes drainage channel and grate.

Before using this product in any application not indicated in this catalogue, please perform a test or refer to the product's technical sheet.



square grates

| standard n squared | | | sun | | |
|--------------------|--------------|------------------|-----------|--------------|------------------|
| SAP | Presentation | P/EU | SAP | Presentation | P/EU |
| 100148572 | 1ud/box | 44.22 p/u | 100114593 | 1ud/box | 57.22 p/u |



| square chrome | | | square tile | | |
|---------------|--------------|------------------|-------------|--------------|-------------------|
| SAP | Presentation | P/EU | SAP | Presentation | P/EU |
| 100293010 | 1ud/box | 51.92 p/u | 100293012 | 1ud/box | 160.56 p/u |



Tile not included in the grate.

All references include drain channel and grate.

Before using this product in any application not indicated in this catalogue, please perform a test or refer to the product's technical sheet.

imperbox

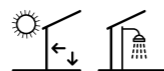

imperbox is paste, ready-to-use waterproofing system specially recommended for waterproofing plasterboard indoors. Compatible with type C2 cement-based adhesive as per EN 12004. Indoor use.

Paste with water-dispersed acrylic polymers that provide it with excellent bonding and deformability properties, which means it can be used over the most common types of substrates used in construction. Special pieces and bands available for waterproofing joints and other critical spots.



Features:

- Water-based paste.
- Indoor waterproofer.
- Excellent adherence. Flexible.
- Good chemical resistance.
- Quick and easy application.

Materials:

- Absorbent and non-absorbent ceramic tiles. Porcelain tiles with a water absorption < 0.5% as per EN-ISO 10545-3.
- Glass mosaic.
- Natural stone and marble.

Substrates:

- Cement covered floors and walls .
- Anhydrite or plaster covered floors and walls .
- Concrete slabs.
- Plasterboards.
- Plywood boards.

Coverage:

- Bond coat
- One-layer application 1.5 kg / m²
- Waterproofing
- Two-layer application 3.6 kg / m²
- Mean thickness per **imperbox** layer: 1.5 mm

Recommended use:

- Private bathrooms. Built in showers.
- Public toilets and showers.
- Spas and premises in permanently damp environments.
- Balconies, covered terraces, cornices and gutters.
- Adhesion promoter on old vinyl and polyurethane adhesives.
- Do not use in outdoors surfaces greater than 10 m².

Angles and waterproof bands:

Special pieces made of waterproof thermoplastic rubber, mounted on polyester sheets which allow laying with type C2 cement-based adhesives as per EN 12004. Specially designed for waterproofing critical spots.

- 1. Inner angle:** Piece for sealing inner corners.
- 2. Outer angle:** Piece for sealing outer corners.
- 3. Waterproof band:** 8 cm wide waterproofing band for sealing edges, level changes and movement joints.



imperbox

| SAP | | Presentation | P/EU |
|-----------|-----------------------|-------------------------|------------------|
| 100006223 | imperbox manhattan | 10 Kg can 450 Kg/pallet | 8.28 p/kg |
| 100006210 | outer angle | unit | 8.73 p/u |
| 100006211 | inner angle | unit | 8.73 p/u |
| 100081531 | 10 ml waterproof band | Roll 10 m | 4.67 p/m |
| 100006221 | 50 ml waterproof band | Roll 50 m | 4.49 p/m |

imperband

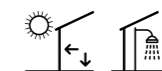

imperband is a waterproof sheet, specially designed for indoor waterproofing of ceramic wall and floor coverings.

It is a 0,5mm thick polymer membrane with a double thermoplastic polyolefin sheet and covered on both sides by non woven polyester fibers that allow it to be bonded to surfaces using cement-based adhesives. Ideal for use in new construction and refurbishment of showers and baths, and any indoor environment permanently affected by damp.

Certifications/Standards:

Avis technique: CSTB 13/16-1319_V1.1

Features:

- Double thermoplastic polyolefin membrane covered on both sides by non woven polyester fibers.
- Maximum waterproofing with minimal thickness (0.5 mm).
- Direct installation of the tile on the sheet.
- Good chemical resistance.
- Quick and easy application.

Installation:

- **imperband** sheet is compatible with type C2 cement-based adhesive as per EN 12004.
- In case of surfaces bigger than the length of the sheet, overlap two 10 cm sheets and bond with C2 adhesive.
- In waterproofing of floors, leave an excess of sheet of at least 10 cm in all the spots where floor meets the wall.
- Be extremely cautious when connecting the sheet to the drainage systems.
- Once the **imperband** sheet has been installed, cover with the chosen floor covering. Never leave exposed to direct sunlight.

Recommended use:

- Private bathrooms. Built in showers.
- Public toilets and showers.
- Spas and premises in permanently damp environments.
- Balconies and terraces smaller than 10 m².
- Do not use in outdoors surfaces greater than 10 m².

Materials:

- Absorbent and non-absorbent ceramic tiles. Porcelain tiles with a water absorption < 0.5% as per EN-ISO 10545-3.
- Glass mosaic.
- Natural stone and marble.

Substrates:

- Cement covered floors and walls .
- Concrete slabs.
- Plasterboards.
- On anhydrite or plaster substrates apply **uniprim**, previously to the cement based adhesive

imperband

| SAP | | Presentation | P/EU |
|-----------|-----------|---|-------------------------------|
| 100276193 | imperband | roll 30 m ² 720 m ² /pallet | 15.27 p/m ² |
| 100276212 | imperband | roll 5 m ² 480 m ² /pallet | 15.47 p/m ² |



sylastic Premium

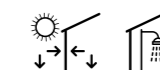

sylastic Premium is a single-component cementitious waterproofing material with excellent adhesion and deformability, both under positive and negative pressure. Compatible with type C2 cementitious adhesives according to EN 12004, it can be used to waterproof substrates prior to installing tiles. Indoor and outdoor use.

It avoids the need for screeds between the waterproofing and the tile, which reduces the thickness of the system. Application is done in two successive coats with a total thickness of at least 2 mm. Special pieces and bands are available for waterproofing joints and other critical points.



Features:

- Single-component waterproofing mortar
- Waterproofing for both positive and negative hydrostatic pressure
- Waterproofing of interiors and exteriors
- Maximum waterproofing with the minimum thickness (2 mm)
- Suitable for direct installation of tiles with cementitious adhesive
- Excellent adherence and maximum deformability
- Permeable to water vapor, prevents moisture condensation
- Suitable for direct contact with water
- Mixing water: 3.6 liters per 15 kg bag

Recommended use:

- Shower trays and cabins, bathrooms, spas and facilities in environments with permanent humidity
- Exterior terraces and balconies
- Pools and facilities in direct contact with water
- Basements, elevator shafts or tunnels even below the water table
- Cisterns and tanks in direct contact with water
- Repair of cracked screeds and plasters

Materials:

- Absorbent and non-absorbent tiles. Porcelain stoneware (water absorption <0.5% according to EN-ISO 10545-3)
- Glass mosaics
- Natural stones and marbles

Substrates:

- Cement mortar floors and plasters
- Concrete sheets
- Existing wall and floor tiles
- Plasterboard sheets.

Coverage:

- Waterproofing:
 - First layer: > 2 Kg / m²
 - Second layer: > 1 Kg / m²
 - Total waterproofing: > 3 Kg / m²
- Sylastic Premium total minimum thickness: 2mm
- Coverage per millimetre of thickness of sylastic Premium: 1,5 Kg/m²

Before applying sylastic Premium, moisten the support with water.

On substrates which are cracked or potentially subject to slight movements, reinforce the second layer of sylastic Premium with a fiberglass mesh.

Do not apply on plaster supports.

| sylastic Premium | | | |
|------------------|-----------------------|------------------------|------------------------------|
| SAP | | Presentation | P/EU |
| 100316193 | sylastic Premium | 15 Kg bag | 4.84 p/kg |
| 100288372 | 50 m fiberglass mesh | 50 m ² roll | 2.67 p/m ² |
| 100006210 | outer angle | unit | 8.73 p/u |
| 100006211 | inner angle | unit | 8.73 p/u |
| 100081531 | 10 ml waterproof band | 10 m roll | 4.67 p/m |
| 100006221 | 50 ml waterproof band | 50 m roll | 4.49 p/m |

pool-deck

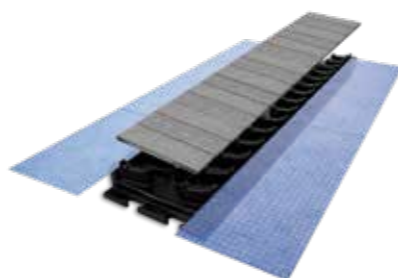
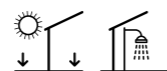

Drainage system for pools and terraces covered with porcelain tiles. This new water collection channel system is prepared to receive PORCELANOSA Grupo tiles and allows water to drain through the open joints between them. Compatible with any exterior waterproofing system, pool-deck replaces the traditional metal or plastic grates, completely changing the finish and durability of any outdoor flooring.

Available for 19.3 and 25 cm wide tile pieces. Professional system.

Features:

- Drainage through the open perimeter joint around the tile pieces. Drain joint width: 7mm
- Compatible with all butech exterior waterproofing systems: sylastic and lamitech n.
- Compact; only 55 mm thick channel plus tile.
- Light system, only 9 kg / m²
- High compressive strength: 2000 kpa

Recommended use:

- Drainage of interior and exterior flooring.
- Private and public showers.
- Terraces and pools
- Especially recommended for the following formats:
 - PAR-KER 193 x 1200 mm
 - PAR-KER 193 x 1800 mm
 - PAR-KER 250 x 1500 mm

Materials:

- Non-slip porcelain tile pieces
- STON-KER antislip
- PAR-KER antislip
- SOLID-KER antislip

Supports:

- Cement mortar screeds

pool-deck complements

pool-deck channel: 95 cm long channel with internal V-slope, which includes heat-sealed IMPERBAND waterproofing sheet over the eaves of the channel.

pool-deck adjustment Channel: Adjustment piece of different length measurements with internal V-slope, which includes heat-sealed IMPERBAND waterproofing sheet over the eaves of the channel. To complete the measurement required by the installation, these pieces will be available in the following measures: 15, 25, 35, 45, 55, 65, 75 and 85 cm.

pool-deck drain: Drain piece with internal V-shaped slope, which includes IMPERBAND waterproofing sheet heat-sealed over the eaves of the channel and a special drain designed for this system that withstands high pressures and is resistant to products commonly used in swimming pools.

pool-deck corner: Corner piece with internal V-slope, including IMPERBAND waterproofing sheet heat-sealed over the eaves of the channel.

pool-deck corner drain: Corner drain piece with internal V-slope, which includes heat-sealed IMPERBAND waterproofing sheet over the eaves of the channel and a special drain designed for this system that withstands high pressures and is resistant to products commonly used for swimming pools.

pool-deck side: Channel closure / start terminal that includes heat-sealed Imperband waterproofing sheet over the eaves of the channel.

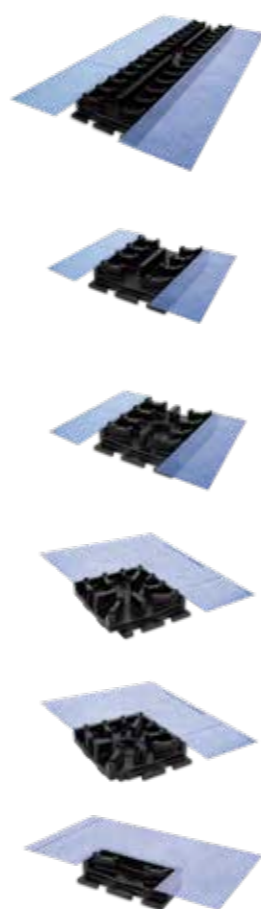

pool-deck 25 cm

| SAP | | P/EU |
|-----------|------------------------------------|------------|
| 100284628 | pool-deck channel 25x95 | 156.62 p/u |
| 100284678 | pool-deck adjustment channel 25x15 | 95.79 p/u |
| 100284682 | pool-deck adjustment channel 25x25 | 104.12 p/u |
| 100284683 | pool-deck adjustment channel 25x35 | 112.47 p/u |
| 100284684 | pool-deck adjustment channel 25x45 | 120.78 p/u |
| 100284667 | pool-deck adjustment channel 25x55 | 129.12 p/u |
| 100284648 | pool-deck adjustment channel 25x65 | 137.44 p/u |
| 100284668 | pool-deck adjustment channel 25x75 | 145.77 p/u |
| 100284669 | pool-deck adjustment channel 25x85 | 154.11 p/u |
| 100284681 | pool-deck drain 25x29,6 | 109.97 p/u |
| 100284665 | pool-deck corner 25x27,4 | 103.32 p/u |
| 100284680 | pool-deck corner drain ext 25x27,4 | 114.97 p/u |
| 100320031 | pool-deck corner drain int 25x27,4 | 114.97 p/u |
| 100284685 | pool-deck side 25x6,5 male | 103.32 p/u |
| 100289060 | pool-deck side 25x6,5 female | 103.32 p/u |

pool-deck 19.3 cm

| SAP | | P/EU |
|-----------|--------------------------------------|------------|
| 100284673 | pool-deck channel 19,3x95 | 140.78 p/u |
| 100284644 | pool-deck adjustment channel 19,3x15 | 86.60 p/u |
| 100284664 | pool-deck adjustment channel 19,3x25 | 94.50 p/u |
| 100284674 | pool-deck adjustment channel 19,3x35 | 101.50 p/u |
| 100284675 | pool-deck adjustment channel 19,3x45 | 109.14 p/u |
| 100284646 | pool-deck adjustment channel 19,3x55 | 116.79 p/u |
| 100284653 | pool-deck adjustment channel 19,3x65 | 124.07 p/u |
| 100284676 | pool-deck adjustment channel 19,3x75 | 140.78 p/u |
| 100284638 | pool-deck adjustment channel 19,3x85 | 138.97 p/u |
| 100284637 | pool-deck drain 19,3x23,9 | 99.32 p/u |
| 100284663 | pool-deck corner 19,3x21,7 | 93.13 p/u |
| 100284670 | pool-deck corner drain ext 19,3x21,7 | 103.32 p/u |
| 100320040 | pool-deck corner drain int 19,3x21,7 | 103.32 p/u |
| 100284654 | pool-deck side 19,3x6,5 male | 93.13 p/u |
| 100289037 | pool-deck side 19,3x6,5 female | 93.13 p/u |

terrace drain



The **floor drain** from **butech** is a drain for terraces and outdoor floors. It features a wide dish around the grating, which ease the connection to waterproofing sheets. Available with horizontal and vertical outlet, it helps to solve easily and effectively outdoor waterproofing and drainage.

The 10 cm connecting piece between the grating and the drain can be cut, so that it can be installed with glass mosaics up to natural stones. Includes steel grating.

Recommended use:

- Drain designed for connecting with waterproofing sheet.
- Specially designed for **lamitech n** waterproofing outdoor terraces and floors.
- Vertical outlet.

Terrace drain complements

Terrace drain connection:

Clamp for fixing **lamitech n** waterproofing sheet to drain. Includes stainless steel clamp, rubber o-ring and 6 fixing screws.



Terrace drain features:

- 190 mm high drain.
- Discharge speed. 1.6 l/s.
- 75/110 mm vertical outlet.
- 36 cm diameter crown for **lamitech n** waterproofing sheet fixation.
- Includes u-bend.
- 143 x 143 mm steel grating.



bathroom drain



The **bathroom drain** from **butech** is a drain for built in shower trays. It features a wide dish around the grating, which ease the connection to the imperband waterproofing sheet. Available with horizontal and vertical outlet, it helps to solve easily and effectively indoor waterproofing and drainage.

The 10 cm connecting piece between the grating and the drain can be cut, so that it can be installed with glass mosaics up to natural stones. Includes steel grating.

Recommended use:

- Drain designed for connecting with **imperband** waterproofing sheet.
- Specially designed for waterproofing built in showers.
- Available with horizontal or vertical outlet

Bath drain complements

Bathroom drain connection:

Clamp for fixing imperband sheet to drain. Includes stainless steel clamp, rubber o-ring and 6 fixing screws.



Features for horizontal bathroom drain:

- 75 mm high drain.
- Discharge speed. 0.6 l/s.
- 50 mm horizontal outlet.
- 22 cm diameter crown for **imperband** fixation.
- Optional outlet for serial connections.
- Includes u-bend.
- 10 x 10 cm steel grating.



Features for vertical bathroom drain:

- 140 mm high drain.
- Discharge speed. 0.9 l/s.
- 50 mm vertical outlet.
- 26.5 cm diameter crown for imperband fixation.
- Includes u-bend.
- 10 x 10 cm steel grating.



| Terrace drain | | | |
|---------------|------------------------|--------------|------------------|
| SAP | | Presentation | P/EU |
| 100005827 | 75/110 vertical drain | 1 ud/box | 86.99 p/u |
| 100005829 | floor drain connection | 1 ud/box | 79.07 p/u |

| bath drain | | | |
|------------|---------------------------|--------------|------------------|
| SAP | | Presentation | P/EU |
| 100005822 | 40/50 horizontal drain | 1 ud/box | 50.38 p/u |
| 100005823 | 50 vertical drain | 1 ud/box | 51.24 p/u |
| 100005825 | bathroom drain connection | 1 ud/box | 27.63 p/u |

Before using this product in any application not indicated in this catalogue, please perform a test or refer to the product's technical sheet.

Before using this product in any application not indicated in this catalogue, please perform a test or refer to the product's technical sheet.

butech anti-cracking mat



Decoupling sheet for floors undergoing low and medium movements.

This membrane reduces the transfer of tensions and stresses between the substrate and the flooring, protects the flooring against the appearance of cracks caused by sideways movements between the slabs forming the substrate and allows porcelain or natural stone flooring to be laid on substrates with medium and low movements. Especially recommended on floors built with timber panels.



Features:

- Closed-cell elastomer sheet coated on both sides with non-woven fibers that allow cement-based adhesives to be anchored.
- It allows for direct laying of ceramic tiles with cement-based adhesive types C2 S1 according to EN 12004.

| | |
|------------------|---------------------------------|
| Color: | White |
| Roll dimensions: | 15 m ² 1500 x 100 cm |
| Roll weight: | 12.35 kg/roll |
| Sheet thickness: | 1.5 mm |
| Sheet density: | 525 gr/m ² |

Materials:

- Stoneware and porcelain stoneware floors, even large formats.
- Natural stones and marbles, even large formats.

The use of butech anti-cracking mat is not recommended:

- Chemically resistant floor coverings
- Under parquet floors

Final use:

- Indoor and outdoor floor tile coverings
- Residential and public concurrence floor coverings with pedestrian traffic
- Floor coverings for commercial or industrial use with mechanical requirements, even with wheel circulation
- Floors with built-in heating
- Suitable for kitchens, bathrooms and water-bearing areas
- Suitable for floor renovations

We do not recommend the use of butech anti-cracking mat in:

- Indoor and outdoor walls
- Supports exposed to bending movements
- On structural joints or movement joints of the support

butech anti-cracking mat

| SAP | Presentación | P/EU |
|-----------|--|-------------------------------|
| 100227223 | Roll 15 m ² 450 m ² / pallet | 10.97 p/m ² |

lamitech n



lamitech n is a multilayer polymer sheet, specially designed for outdoor floors decoupling. Protects tiles against substrate tensions, reducing the risk of breakage and piece lifting. Suitable for outdoor waterproofing.

Coextruded HDPE/EVAC membrane, with one side covered with polyester fibers and the other one with polyester entwined felt, that allows laying with cement-based adhesives. Absorbs tensions, reducing their transmission to the ceramic floor. Indoor and outdoor use.

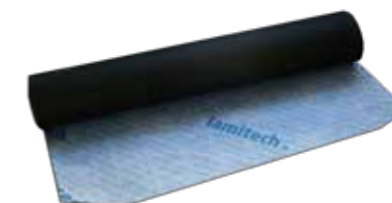

Features:

- Multilayer HDPE/EVAC polymer membrane covered with polyester fibers.
- Maximum outdoors waterproofing with minimal thickness (3,4 mm).
- It allows for direct laying of ceramic tiles with cement-based adhesive.
- Good chemical resistance.
- Improves impact noise reduction.
- Quick and easy application.

Installation:

- **lamitech n** sheet is compatible with type C2 cement-based adhesive as per EN 12004.
- Place sheets side by side, without overlappings. In case of using it as waterproofer, proceed to sealing sheet joints with **sylastic** waterproof mortar and **lami-band 200** waterproof band..
- In waterproofing of floors, lengthen the waterproofing with **lami-band 200** at least 10 cm in all the spots where floor meets the wall.
- In movement joints, use flexible tape waterproof band.
- Be extremely cautious when connecting the sheet to the drainage systems.
- Once **lamitech n** has been installed, lay the chosen floor with compatible adhesives. Never leave exposed to direct sunlight.

Recommended use:

- Decoupling of balconies and terraces.
- Waterproofing of outdoor floors.
- Laying of ceramics on wood substrates.
- Laying of floor tiles on cracked substrates.
- Terrace refurbishing.
- Laying of ceramics on substrates which are not set yet or present residual damp.

Materials:

- Absorbent and non-absorbent ceramic tiles. Porcelain tiles with a water absorption < 0.5% as per EN-ISO 10545-3.
- Glass mosaic.
- Natural stone and marble.

Substrates:

- Cement or anhydrite covered floors.
- Concrete slabs.
- Existing floor tiles.
- Plywood boards.

lamitech n

| SAP | Presentación | P/EU |
|-----------|--|-------------------------------|
| 100286750 | lamitech n 5 m roll 150 m ² /pallet | 17.55 p/m ² |
| 100288347 | lami-band 200 mm 30 m roll | 4.51 p/m |
| 100006221 | 50 ml waterproof band 50 m roll | 4.49 p/m |
| 100316193 | sylastic Premium 15 Kg bag | 4.84 p/kg |



SYSTEMS

THICKER 20_{MM}

Bottega caliza, **202** | Bottega acero, **202**
Durango bone, **204** | Durango acero, **204** | Nantes caliza, **206**
Berna caliza, **208** | Berna acero, **208**
Harlem acero, **210** | Newport natural, **210**
Prada acero, **212** | Vela natural, **214**
Rox coal, **216** | Rox grey, **216** | Rox beige, **216**
Riven white, **218** | Riven cream, **218** | Riven brown, **218**
Tanzania white, **220** | Tanzania cream, **220** | Tanzania nut, **220**
Tanzania almond, **222** | Tanzania natural, **222** | Vela topo, **222**

PLOTS AND RAFx ACCESSORIES

Normal plot, **224** | Ultra plot, **224** | Plot n, **224** | Basic plot, **225**
End profile for RAFx, **225** | Vertical enclosure clip, **225**

FLOATING STAIRS

Floating stairs, **229**



THICKER 20_{MM}

SYSTEMS



Bottega caliza



bottega caliza antislip *100285287
23 15/32" x 23 15/32" x 25/32" (59,6x59,6x2cm)

bottega caliza antislip *100323742
2 23/64" x 4 23/32" x 25/32" (60 x 120 x 2 cm) 100320627

Recommended joint: **colorstuk rapid n perla** 100275760

Bottega acero



bottega acero antislip *100285276
23 15/32" x 23 15/32" x 25/32" (59,6x59,6x2cm)

bottega acero antislip *100323637
2 23/64" x 4 23/32" x 25/32" (60 x 120 x 2 cm) 100323357

Recommended joint: **colorstuk rapid n manhattan** 100236464

Adhesive: **super-flex S2** 100142757
Packaging: 2 units/box - 0,71 m²/box - 22,73 m²/pallet



Durango bone



Durango bone antislip *100308829
23 15/32" x 23 15/32" x 25/32" (59,6x59,6x2cm)

Recommended joint: **colorstuk especial n nacaré** 100238235

Durango acero



Durango acero antislip *100308870
23 15/32" x 23 15/32" x 25/32" (59,6x59,6x2cm)

Durango acero antislip *100323667
2 23/64" x 4 23/32" x 25/32" (60 x 120 x 2 cm) 100323394

Recommended joint: **colorstuk especial n ash** 100204245

Adhesive: **super-flex S2** 100142757
Packaging: 2 units/box - 0,71 m²/box - 22,73 m²/pallet



Nantes caliza



Nantes caliza antislip *100308828
23 15/32" x 23 15/32" x 25/32" (59,6x59,6x2cm)

Recommended joint: **colorstuk especial n nacaré** 100238235

Adhesive: **super-flex S2** 100142757
Packaging: 2 units/box - 0,71 m²/box - 22,73 m²/pallet

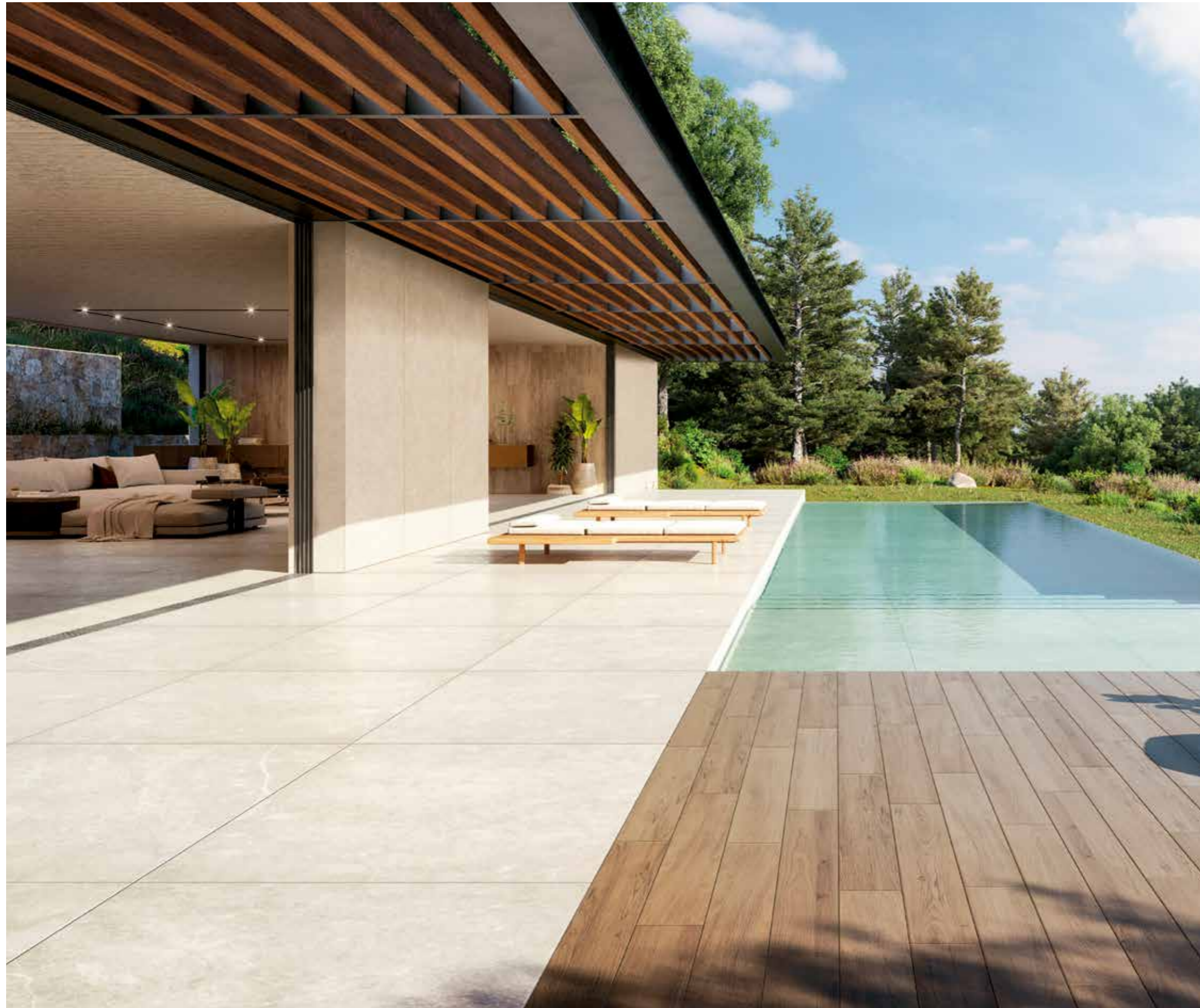

Berna caliza



Berna caliza antislip *100308863
23 15/32" x 23 15/32" x 25/32" (59,6x59,6x2cm)

Recommended joint: **colorstuk rapid n beige** 100236808

Berna acero



Berna acero antislip *100308856
23 15/32" x 23 15/32" x 25/32" (59,6x59,6x2cm)

Berna acero antislip *100323966
2 23/64" x 4 23/32" x 25/32" (60 x 120 x 2 cm) 100320618

Recommended joint: **colorstuk rapid n manhattan** 100236464

Adhesive: **super-flex S2** 100142757
Packaging: 2 units/box - 0,71 m²/box - 22,73 m²/pallet



Harlem acero



Harlem acero antislip *100308854
23 15/32" x 23 15/32" x 25/32" (59,6x59,6x2cm)

Recommended joint: **colorstuk rapid n manhattan** 100236464

Newport natural



Newport natural antislip *100308855
23 15/32" x 23 15/32" x 25/32" (59,6x59,6x2cm)

Recommended joint: **colorstuk rapid n gris** 100236834

Adhesive: **super-flex S2** 100142757
Packaging: 2 units/box - 0,71 m²/box - 22,73 m²/pallet



Prada acero



Prada acero antislip *100308857
 23 15/32" x 23 15/32" x 25/32" (59,6x59,6x2cm)

Recommended joint: **colorstuk rapid n gris** 100236834

Adhesive: **super-flex S2** 100142757
 Packaging: 2 units/box - 0,71 m²/box - 22,73 m²/pallet



Vela natural



vela natural antislip *100309733
 23 15/32" x 23 15/32" x 25/32" (59,6x59,6x2cm)

Recommended joint: **colorstuk rapid n gris** 100236834

Adhesive: **super-flex S2** 100142757
 Packaging: 2 units/box - 0,71 m²/box - 22,73 m²/pallet



Rox coal



Rox coal antislip *100167343
23 15/32" x 23 15/32" x 25/32" (59,6x59,6x2cm) 100321549

Recommended joint: **colorstuk rapid n cemento** 100236449

Rox grey



Rox grey antislip *100162534
23 15/32" x 23 15/32" x 25/32" (59,6x59,6x2cm) 100319255

Recommended joint: **colorstuk rapid n gris** 100275760
colorstuk rapid n manhattan 100236464

Rox beige



Rox beige antislip *100162750
23 15/32" x 23 15/32" x 25/32" (59,6x59,6x2cm) 100319261

Recommended joint: **colorstuk rapid n beige** 100236808

Adhesive: **super-flex S2** 100142757
Packaging: 2 units/box - 0,732 m²/box - 21,96 m²/pallet



Riven white



Riven white antislip rect. *100229792
 11 39/64" x 47 1/4" x 25/32" (29,5x120x2cm) 100234121

Recommended joint: **colorstuk rapid n gris** 100236834

Riven cream



Riven cream antislip rect. *100229737
 11 39/64" x 47 1/4" x 25/32" (29,5x120x2cm) 100234103

Recommended joint: **colorstuk rapid n beige** 100236808
colorstuk rapid n gris 100236834

Riven brown



Riven brown antislip rect. *100229775
 11 39/64" x 47 1/4" x 25/32" (29,5x120x2cm) 100234064

Recommended joint: **colorstuk rapid n manhattan** 100236464

Adhesive: **super-flex S2** 100142757
 Packaging: 2 units/box - 0,708 m²/box - 22,66 m²/pallet



Tanzania white



Tanzania white antislip *100323793
29,5 x 120 x 2 cm 100323782

Recommended joint: **colorstuk rapid n ash** 100204245

Tanzania silver



Tanzania silver antislip *100323767
29,5 x 120 x 2 cm 100323790

Recommended joint: **colorstuk especial n ash** 100204245

Tanzania nut



Tanzania nut antislip *100323785
29,5 x 120 x 2 cm 100323772

Recommended joint: **colorstuk especial oak** 100204255

Adhesive: **super-flex S2** 100142757
Packaging: 2 units/box - 0,708 m²/box - 22,66 m²/pallet



Tanzania almond



Tanzania almond antislip *100323765
29,5 x 120 x 2 cm 100323771

Recommended joint: **colorstuk especial iroko** 100236834

Tanzania natural



Tanzania natural antislip *100323766
29,5 x 120 x 2 cm 100323791

Recommended joint: **colorstuk especial elm** 100234451

Adhesive: **super-flex S2** 100142757
Packaging: 2 units/box - 0,708 m²/box - 22,66 m²/pallet

plots adjustables (normal plot)

| | |
|------------------------|---|
| Type | Adjustable |
| Compression resistance | 750 kg/unit. aprox. |
| Dimensions | Lower support base Ø 150 mm Upper head Ø 92 mm |
| Heights | Minimum 30 mm Maximum 100 mm |
| Slopes | From flat to 2 % |



plots adjustables (ultra plot)

| | |
|------------------------|--|
| Type | Adjustable |
| Compression resistance | 1.000 kg/unit. aprox. |
| Dimensions | 100/130: Lower support base Ø 150 mm Upper head Ø 92 mm Rest of the heights: Lower support base Ø 160 mm Upper head Ø 140 mm |
| Heights | Minimum 100 mm Maximum 670 mm |
| Slopes | De 0 a 2 % |



plots adjustables (plot n)

| | |
|------------------------|--|
| Type | Adjustable |
| Compression resistance | 2.800 kg/unit. aprox. |
| Dimensions | Lower support base Ø 205 mm Upper head Ø 150 mm |
| Heights | Minimum 30 mm Maximum 670 mm |
| Slopes | From flat to 3 % |



plots non adjustables (basic plot)

| | |
|------------------------|----------------------------|
| Type | No regulable - Apilable |
| Compression resistance | 8.000 kg/unid. |
| Dimensions | 100 x 100 mm y 115 mm de Ø |
| Heights | 10 mm 15 mm 20 mm |



end profile for RAFx

butech's top profile is a solution to hide the aesthetic inconvenience that occurs when a step has to be made with the Raised Floor. This profile, in addition to hiding the edge of the ceramic piece, allows us to anchor a vertical piece to the plot to hide the body of the plots*.

Made of aluminum, and with a length of 1200mm, it can be used in thickened units (SAP: 100280081) with a 20mm depth, and in double-piece units (SAP: 100290783) with a 23mm depth. For a correct clamping of the vertical piece from its lower part, several units of the Lower Clip (SAP: 100253748) will be necessary.

*Option valid only for **plot n**

end profile for RAFx

| | |
|-----------|----------------------------|
| SAP | |
| 100280081 | 1200 mm thickened |
| 100290783 | 1200 mm double-piece units |
| 100253748 | lower clip |

vertical enclosure clip

These clips have two components: upper clip, fixed to the pedestal head, and lower clip, which goes on a previously cut pedestal base.

The perimeter panels are easily installed with these clips.

For a correct installation, the pedestal base has to be cut as shown in the images.

Only compatible with **plot n**

vertical enclosure clip

| | |
|-----------|---|
| SAP | |
| 100253729 | vertical enclosure system lower clip upper clip |





FLOATING STAIRS

SYSTEMS



Floating stairs

In architecture and in the construction sector in general, stairs are considered the main backbone of the room. It is a unique piece, both in its design and its functionality. Depending on the interior design, stairs can be subtly adapted to the interior design or highlight a specific area or element.

On the other hand, floating stairs expand the visual space and favour a better lighting of the environment.

A levitation effect is achieved where the steps, using the same units as the floor, rise through the space floating in the air.

Characteristics:

Customized steps are available, but the standard measurements are:

- Length: 80 / 90 / 100 / 120 cm
- Width: greater than or equal to 28 cm
- Thickness: greater than 9 cm

This system is designed to be used primarily indoors, but can be adapted to outdoor projects.

System elements:



1. Anchoring: depends on the type of wall. Only available for concrete and metal beams.

2. Step core: steel structure (S275) with lacquered finish and lateral reinforcement for fixing the handrail.

3. Adhesive: reactive resin adhesive for fixing the box to the stair structure.

4. Step box: OBS case covered with the PORCELANOSA Grupo flooring collection (EN 14411: 2012) chosen by the client. Supplied completely finished, ready to be installed.

* For a correct fixation, the union of these three elements will be made with a two-component epoxy adhesive.

KEY

***Iconography**

Product name **CEMENT-BASED ADHESIVES** **Product family**

one-flex Premium  **Product picture**

Product certifications and standards **Certifications/Standards:** EN 12004 C2 TE S1

Product features **Features:** Excellent adherence. Flexible. Bonding material, with excellent mixing and application features. High initial adherence and no sagging. Thixotropic. Extended working times. Open time higher than 30 min. Application thickness from 2 to 15 mm. Broad spectrum in the percentage of mixing water: **one-flex premium white** Mixing water: 8.1 - 8.9 L per 25 kg bag **one-flex premium grey** Mixing water: 6.5 - 7.2 L per 25 kg bag

Recommended uses: Floors and walls with rectified tiles Large format indoor porcelain wall tiles Large format interior porcelain floor tiles and outdoor use High traffic floor tiles Floor tiles on radiant heating Pools and damp environments On bonded facades, replace mixing water with **unilax** additive

Types of applications where the use of the product is recommended

Types of substrates where the use of the product is recommended **Substrates:** Cement-based screeds Cement render Concrete slabs and floors Anhydrite screeds, having previously applied **uniprim** Plasters, having previously applied **uniprim** Large-format ceramic brick Pre-existing tiles/mosaic/stones* Plasterboard panels Cement-based panels Mixed with **unilax**, acoustic insulation **fonopacr**

Materials: Large format ceramic tiles High-absorption ceramic tiles and stoneware Porcelain tiles Glass mosaic Natural stone and marble not prone to staining

Types of materials where the use of the product is recommended

Product Coverage **Coverage:** Small format and mosaic / Trowel U4: 2-3 kg/m² Medium format / Trowels U6-U8: 3-5 kg/m² Large format / Trowels U10-U12: 5-7 kg/m²

















Regardless of our recommendations for use indicated for this adhesive, respect the installation regulations in force in each country.
* super-prim improves the adherence on polished ceramics and glossy finishing tiles
Before using this product in any application not indicated in this catalogue, please perform a test or refer to the product's technical sheet.

Product name **one-flex Premium** **Value**

| SAP | Description | Presentation | Euro pallet | P/EU |
|-----------|-------------------------|--------------|----------------|-----------|
| 100201526 | one-flex Premium blanco | bag 25 kg | 1000 kg/pallet | 1.29 p/kg |
| 100201543 | one-flex Premium gris | bag 25 kg | 1000 kg/pallet | 1.23 p/kg |
| 100277878 | r-eco | bag 250 gr | | 1.02 p/u |

Type of packaging for the product

*Iconography

| | | | | |
|---|---|---|--|---|
|  |  |  |  |  |
| Exterior floor | Exterior wall | Shower area | slight - moderate - hard pedestrian traffic | Non slip |
|  |  |  |  |  |
| Interior floor | Interior floor | Textured finish | Tone variations V3: moderate | Rectified |
|  |  |  |  |  |
| Matt | Raised Access Flooring | Technical grain | Slip resistance R11: Increased static friction R13: Very high static friction | (CTE) RD Slip resistance CL3: RD > 45 |
|  | | | | |
| Exterior | | | | |



PORCELANOSA Showrooms

ESPAÑA

A CORUÑA

SUMINISTROS VIA-MAR_ A Coruña - Médico Rodríguez, 18-20. +34 981 279 431
SUMINISTROS VIA-MAR_ A Coruña · Avda. Fraga Iribarne, s/n +34 981 772 190
JESUS PEDROUZO_ Carballo - Valle Inclán 24, Bajo +34 981 701 120
CAPELO GARCIA, MANUEL FELIPE · LG San Mamed, s/n. Carnota. +34 981 857 081
CEE_ B. FANDIÑO LADO, S.L. · CL Valdepeñas, s/n. +34 981 748 003 +34 981 748 004
ALMACENES CASTILLO DE MUROS, S.L. · Rosalía de Castro, 5. Pol. Ind. Muros +34 981 826 368
PEREZ DOMINGUEZ PUEBLA_ Puebla del Caramiñal · Angustia, 30. +34 981 830 214
ALMACENES SEROMAVI_ Santa Comba · Avda. Santiago, 18. +34 981 880 104 +34 981 818 617
PORCELANOSA_ Santiago de Compostela - Rua Clara Campoamor, 13-15 (Montouto) +34981 509270
PORCELANOSA_ Santiago de Compostela - Poligono Comercial Costa Vella +34 981 897 595

ÁLAVA

JORGE FERNÁNDEZ_Vitoria-Gasteiz · Polígono de Jundiz. Paduleta, 53. +34 945 244 250
JORGE FERNÁNDEZ_Vitoria-Gasteiz · Los Herrán, 30. +34 945 254 755 +34 945 259 668

ALBACETE

PORCELANOSA ALBACETE · Avda. Gregorio Arcos, 32. (Pol. Campollano) +34 967 243 658 +34 967 173
OLIVARES MAT. CONSTRUCCIÓN · Avda. Reyes Católicos, 168. Villarrobledo. +34 967 138 105

ALICANTE

AURA · Avda. Juan Gil-Albert, 63 Bajo. Alcoy. +34 965 525 101
Clave Ceramica · Avda. Europa, 29. Benissa. 865663101
ELDECO · Carretera N-332 Partida Cap Blanch, 38A. Altea. +34 966 874 360 +34 966 873 543
HIJOS DE JUAN RIBES · Avda. de la Estación, 2. Benissa. +34 965 730 419
PORCELANOSA ELCHE · Avda. Alicante, 105. +34 966 610 676 +34 966 610 700
AZULEJOS JAVEA · Liverpool, 4. Jávea. +34 965 791 036
PORCELANOSA_San Juan · Carretera Valencia, km 88. +34 965 656 200 +34 965 655 644
PORCELANOSA_Finestrat · Parque Comercial La Cala, Av. de Finestrat, 11, 13. +34 965 36 41 66
PORCELANOSA_Orihuela Costa (Torrevieja - La Zenia). CC Cabo Roig. Orihuela. Cruce Calle Caspio con Calle Cabo de Gata, Orihuela. +34 647 653 892

ALMERÍA

PORCELANOSA_Almería · Parque Comercial Viapark, Parcela 1, Vicar. +34 950 325 575 +34 950 338 651

ASTURIAS

PORCELANORTE_Gijón · S.L. Menéndez Pelayo 30, Gijón. +34 984 396 462
PORCELANOSA_Oviedo · Pol. Espíritu Santo. Calle Dinamarca, s/n. +34 985 791 526 +34 985 985 963

ÁVILA

PAVIMARSA_Ávila · Pol. Ind. Vicolozano - Parcela 2. +34 920 259 820 +34 920 259 821

BADAJOZ

PORCELANOSA_Mérida · Avda. Reina Sofía, 8. +34 924 330 218 +34 924 330 315
MUNDO OBRAS · Pol. Ind. Los Caños, Calle Bodium, 27, Zafra. +34 924 551 264 +34 924 551 264

BALEARES

MACODOR · Carretera Calonge - Cala d’Or, km 1,5. Mallorca +34 971 658 210
MAT. DE CONSTRUCCION GALMES SA · Carrer Via Palma, 67, Manacor. +34 971 553 050
A PALLISER SL · Avda. Cap de Cavalleria, 1. Mahón. +34 971 3573 00 +34 971 357 400
PORCELANOSA_Palma de Mallorca · Gran Vía Asima, 21. Pol. Son Castelló. +34 971 430 667
PORCELANOSA_Ibiza · Avda. Llauradors, 7 · Pol. Montecristo. S. Antoni Portmany. +34 971 317 292 CAN
CAN SOLER · Calle del Mar, 167, bajos, Sóller. +34 971 630 219 +34 971 632 311

BARCELONA

PORCELANOSA_Barcelona · Avenida Diagonal, 409. BArcelona. +34 932 438 926
ALANTA SA · Ctra de la Roca km 5,6. Santa Coloma de Gramanet. +34 933 919011
AZULEJOS SAN ANDRÉS · Plaça Mossen Clapes, 2-3. +34 933 455 102 +34 933 461015
BADALONA GRES · Carretera B-500, km 3.2. Tiana. +34 933 950 311
GIL DE NAPOLES · C/ Napoles. 87 Barcelona. +34 655 906 329
GRESS ARGENTONA · Pj Amics Argentona 2, Barcelona. +34 937 414716
ORMAT · Carretera de Vilassar-Argentona km.1, Cabrera del Mar. +34 937 591 139 +34 937 502076
PLANELL · Carretera Manresa km 31. Calaf, Barcelona. +34 938 698 750 +34 938 600 181
CANTARA BARCELONA · C/ Valencia, 312, Barcelona. +34 935 216996
CANTARA SABADELL · Avinguda Rafael de Casanova, 24, Sabadell, Barcelona, +34 935 216991
CANTARA SANT FRUITOS · Pol. Casanova nau 2-7 · Ctra de Manresa a Berga Km 1. +34 935 216992
LOFT CUINA · Carrer La Miranda, 6-8. Cornellá. +34 934 743 793 +34 934 741 305
MATERIALS CASSERRE · San Rafael, Cassares. +34 938 213 770
ANTONI POINT · Carrer Farguell, 31. Gironella. +34 938 228 088 +34 938 250 786
MARESME GRES · Carrer Sant Isidor, 78. Mataró +34 931 615 015
AVELLANET AMBIENTS · Carrer de Montserrat, 7. Mataró. +34 937 903 089
COMERCIAL SOLSAN · Camí Reial, 109. Palau Solita i Plegamans. +34 938 648 125 +34 938 649617
AMARGANT · Carrer Santiago Rusiñol, 96. Pineda de Mar. +34 937 671 416 +34 937 627 488
AMARGANT · Passeig Parc, 1. Sant Pol de Mar. +34 937 600 112 +34 937 600 411
ARQUIMATT MATERIALS I DECORACIÓ · Carrer Sant Jordi, 16. +34 679 531 877
GARRO · Ctra. Sta. Creu de Calafell, km 10,7. Sant Boi de Llobregat. +34 936 545952 +34 938400620 ST.
SUMCO · Carretera de la Segarra, 7-15. Les Roquetes, Sant Pere de Ribes. +34 938 933 066
CORRETTJA · Carrer Mas de Bigas, 8-26. Vic. +34 938 854 261 +34 938 894 733
FERRET I CASULLERAS · C/Sant Martí, 2. Vilafranca del Penedés. +34 93 890 14 19 · +34 93 8170353
PLANELL · Carretera Vilafranca 108-111. Vilanova del +34 938 060 240 +34 938 060 239

BURGOS

BIGMAT FONTECHA · Alcalde Martín Cobos,15. Nave 5 y 6. Burgos. +34 947 485 153 +34 947 483 941
JORGE FERNÁNDEZ · Camino Fuente Basilio, s/n. Miranda de Ebro. +34 947 323 351 +34 947 314 589
JUAN GIL MOLINERO · C/Padilla, 5. Aranda del Duero. +34 947 501 049

CÁCERES

CÁCERES_PORCELANOSA · Avda. Juan Pablo II, 130. +34 927 236 337

CÁDIZ

PORCELANOSA_Algeciras · Carretera de Málaga, km 109. +34 956 635 282 +34 956 635 285
PORCELANOSA_El Puerto de Santa María · Pol. El Palmar. Ctra.Madrid-Cádiz, km 653,2. +34 956 540084
PORCELANOSA_San Fernando · Polígono Tres Caminos, s/n. +34 956 592 360

CANTABRIA

PORCELANOSA_Santander · Avda. Parayas, s/n. +34 942 352 510 +34 942 352 638

CASTELLÓN

PORCELANOSA_Castellón · Parque Comercial Estepark / Av. E.Gimeno s/n. +34 964 506 800
PORCELANOSA_Vinaroz · Carretera N-340, km 1.050,1. +34 964 400 944 +34 964 400 650

CEUTA

BAEZA · Ampliación Muelle de Poniente, 96. Ceuta. +34 956 511 312 +34 956 511 309

CIUDAD REAL

CIUDAD REAL_PORCELANOSA · Carretera de Carrión, 11. +34 926 251 730 +34 926 255 741
LA SOLANA_LOS PEPOTES · Calle Emilio Nieto, 39. +34 926 63 15 80 +34 926 63 38 56

CÓRDOBA

PORCELANOSA_Córdoba · Carretera N-IV, km 404. Pol. de Torrecilla. +34 957 760 024 +34 957 760 123
MUEBLES APARICIO · C. Poligono Industrial los Bermejales, 1. Almedinilla. +34 957 703 074

CUENCA

MAT. DE CONSTRUCCIÓN MARTÍNEZ ORTEGA · Calle 2 de Mayo, 28. Casas de Haro. +34 969 380708
VICOSAZ · Hermanos Becerril, 6 bajo. Cuenca. +34 969 233 200 +34 969 234 475
VICENTE DE LOS RIOS · Avda. del Progreso, 19. Tarancón. +34 969 321 323 +34 969 321 334
JUAN MANUEL MUÑOZ FERNÁNDEZ · C/ de la Feria, 29. Honrubia. +34 969 29 20 44
ALMACENES PAÑOS · Camino de Rubielos, 8. Villanueva de la Jara. +34 967 498 000

GIRONA

ESCLANVÀ BEGUR_MAT. CREIXELL · C/Palafrugell Regencos. Pol. ind. Riera Esclanya, 1. +34 972 300 628
PORCELANOSA_Girona · Carretera Barcelona 120-122-124. +34 972 964 141
LLORET DE MAR_CARMONA · Carretera de Lloret_Vidreres 2,1. +34 972 372 710 +34 972 349 763

GRANADA

ARMILLA_TECMACER · Avda. San Rafael (Junto Sprinter). +34 958 253 081 +34 958 183 367

GUIPÚZCOA

JORGE FERNÁNDEZ · Pol. Ind. Belartzta. Fernando Múgica, 15. san Sebastián. +34 943 376 966

HUELVA

PORCELANOSA_Huelva · Poligono La Paz Naves 1-5 +34 959 543 600 +34 959 237 951

HUESCA

AINSA_COMERCIAL CAMPODARVE · Pol. Ind. Sobrarbe, Naves 11 y 12. +34 974 500267 +34 974 500865
BERGES CENTRO COMERCIAL · Avda. Aragón, 70. Fraga. +34 974 471 439 +34 974 471 439
ERNESTO CANCER · Avda. Pirineos 3-5. Barbastro. +34 974310396
PORCELANOSA_Huesca · Pol. Sepes. Calle Ronda la Industria 1-3 Nave C. +34 974 242 738

JAÉN

PAVIMENTOS AZUGRISA · Pol. Ind. Fte. Granada Vial II. Alcalá La Real. +34 953 582 963
PORCELANOSA_Jaén · Poligono Olivares. Carretera Bailén-Motril, km 323. +34 953 280 757 +34 953
HERNÁNDEZ GÁMEZ · Ctra. Torreblascopedro s/n. Linares. +34 953 693 423 +34 953 693 444
HERNÁNDEZ GÁMEZ · Avda. de la Libertad, 88. Úbeda. +34 953 795 168 +34 953 795 168

LA RIOJA

LOGROÑO_RIOJACER · Avda. de Burgos, 43-45. +34 941 286 021 +34 941 202 271

LAS PALMAS

PORCELANAS Y PAVIMENTOS CANARIOS · Avda. Mesa y López, 61 +34 928 472 949 +34 928 472 944

LEÓN

KOBE DISEÑO Y SUPERFICIES SOLIDAS · C/ Dr. Marañón, 9 bajo. Ponferrada. 649 993 945. 987 455 870
PORCELANOSA_San Andrés del Rabanedo · Ctra. León-Astorga, km 3,5 +34 987 801 570

LLEIDA

PRETENSADOS RIBERA · Ctra. N-230 km 124,5. El Pont de Suert. +34 973 690 063 +34 973 690 400
MATERIALS GERMAN'S MAURI · Carrer Princep de Viana, 36. Lleida. +34 973 232 139 +34 973 247 943
PUJOL ELEMENTS · Carrer Tarragona, 40. Lleida. +34 973 202 350 +34 973 203 113
MATERIALS JORDI VILAR · Carretera Manresa, s/n km.50. Solsona. +34 973 482 077 +34 973 482 373
TARREGA NOUMAG · Júpiter, 7 (Pol. Ind. La Canaleta), Tarraga. +34 607 497 330
PIRINEU CERAMICS · Carretera de Lleida, 28. La Seu d’Urgell. +34 973 351 850
PROJECTES MODULARS PREFABRICATS · Ivars d’Urgell, 20. Plind Neoparc. Lleida. +34 973 603 954
PRETENSADOS RIBERA · Carretera França, 40. (Mig Aran) Vielha. +34 973 641 460 +34 973 642 271
VISAMAT · Avda. del Canal, 84 Baixos. Mollerusa. +34 973801035

LUGO

SONIA GOMEZ GOMEZ · Juan XXIII, Bajo 22. Chantada. +34 982 441 249 +34 982 440 331
ALMACENES BAHIA, S.L. · Maestro Lugilde, 6. Foz. +34 982 140 957 +34 982 132 065
ARIAS NADELA, S.L. · Tolda de Castilla, s/n. Lugo. +34 982 245 725 +34 971 662 816
ARIAS NADELA, S.L. · Crta. N-VI, Km. 498 (Pol. Do Ceao) Lugo. +34 982 221 254
ESTABLECIMIENTOS REY, S.L. · Avda. Diputación, 88. Xove. +34 982 592 006 +34 982 592 071

MADRID

PORCELANOSA_Alcorcón · Carretera N-V, km 15,5. Parque Oeste de Alcorcón +34 916 890 172
PORCELANOSA_Leganés · Avda. Recomba, 13. Pol. la Laguna Salida 53 - M50 +34 914 819 200
PORCELANOSA_Madrid · Alcalá, 514. +34 917 545 161 +34 917 545 555
TIENDA CONCHA ESPINA · Avenida Concha Espina, 18. Madrid.
PORCELANOSA_San Sebastián de los Reyes · Plaza del Comercio, 17. +34 916 623 232

MÁLAGA

PORCELANOSA_Málaga · Victoria de los Ángeles, 1. +34 952 241 375 +34 952 240 092
PORCELANOSA_Marbella · Ricardo Soriano, 65. +34 952 826 868 +34 952 822 880
MATERIALES MUÑOZ PÉREZ · Ferrocarril, 2. Vélez, Málaga. +34 952 507 879 +34 952 504 760

MURCIA

PORCELANOSA_Murcia · Avda. Juan de Borbón, s/n. Parque Comercial Thader +34 968 879 527
LORCACER · Crta. Granada S/N Apdo. Correos 321. Lorca. +34 968 478 130

NAVARRA

CINTRUÉNIGO_CERÁMICAS CECILIO CHIVITE · Pol. Ind. s/n. Variante N-113. +34 948 811 973
MONTEJO CERÁMICAS_Multiva Baja · Pol. Ctra. Tajonar, Calle-A, Naves 2- 4 +34 948 239 065
MONTEJO CERÁMICAS_Pamplona · Navas de Tolosa, s/n. +34 948 224 000 +34 948 226424
MONTEJO CERÁMICAS_Tudela · Ctra. Tudela -Tarazona, Pol. Centro Servicios Tudela +34 948 848 365

PORCELANOSA Showrooms

ESPAÑA

OURENSE

JOSE R. PITEIRA, S.L. · Avda. Julio Rodríguez Soto, 63. Carballiño. +34 988 271 071 +34 988 274 780
BLANCO QUINTAS, S.A. · Avda. Otero Pedrayo, 8. Ourense. +34 988 391 478
Foncaldi S.L. · Carretera de Castadón N°65 Bajo. Pereiro de Aguiar. +34 988 229 651
MAT. DE CONSTRUCCION ER-CA, S.L. · Avda. de Portugal, 44. Verin. +34 988 411 030 +34 988 411 081

PALENCIA

CANTALAPIEDRA · La Puebla, 2. Palencia. +34 979 706 421 +34 979 702 652

PONTEVEDRA

ARCOLAR 2000 · Rua de Venezuela, 40. Silleda. +34 986 580 114
DALARJO, S.L. CL · Alto de la Cruz , s/n. A Estrada. +34 986 570 489 +34 986 570 610
PREFABRICADOS DENA, S.L.Rua de Galicia, 24. Dena, Meaño. +34 986 743 121 +34 986 745 131
PREFABRICADOS DENA, S.L.C/Alexandre Boveda, 82. O Grove. +34 986 702 041 +34 986 733415
ALMACENES CANDA, S.L. · Calle Monserrat, 36-39. Lalin. +34 986 780 184
SANAMIENTOS ROSALES, S.L. · Avda. Doctor Otero Ulloa, 1. Seixo, Marín. +34 986 702 041
SANAMIENTOS ROSALES_Vigo · García Barbón, 139 B. +34 986 228 806
SANAMIENTOS GANDARA_Vilagarcia de Arousa · Avda. La Marina, 126-128 Bajo +34 986 506 640

SALAMANCA

PORCELANOSA_Villares de la Reina · Pol. Villares. Ctra. Salamanca-Valladolid, km 2,2. +34 923243811

SEGOVIA

SEGOCER_El Espinar · Carretera Madrid - La Coruña, km 64. +34 921 172 426 +34 921 171 828
SEGOCER_Segovia · José Zorrilla, 134. +34 921 444 122

SEVILLA

HERNÁNDEZ CARBALLO · Betis s/n. Lora del Río. +34 955 800 473 +34 955 801 439
PORCELANOSA_Sevilla · Tipografía, s/n. Pol. Industrial La Negrilla. (A-92 dir. Granada) +34 954 260540
PORCELANOSA_Tomares · San Roque, s/n. Polígono El Manchón. +34 954 152 792 +34 954 153 188

SORIA

MATERIALES ODORICIO · Pol. las Casas-II. Calles A y J, Parcela 201 +34 975 233 228 +34 975 232 188

STA. CRUZ DE TENERIFE

PORCELANAS Y PAVIMENTOS CANARIOS · Avda. 3 de Mayo, 18. Sta. Cruz de Tenerife. +34 922 209 595

TARRAGONA

COMERCIAL LLAURADO. Carretera de Tivissa, s/n. Mora La Nova. +34 977 400 387
EXPOMAT ALCOVER · Calle Tramuntana, s/n (Poligono Roques Roges). Alcover. +34 977 760 476
EXPOMAT LES BORGES · Ctra Alforja s/n. 660105371
MAUSA EL VENDRELL · Carrer Terrissaires, 1. El Vendrell. +34 977 661 951
MAUSA · Autovía A7 Salida 1.148. Cambrils. +34 977 904 050
MAUSA · A7. Salida 1148. Cambrils. +34 977 360 836

TERUEL

PIQUER · CL Marques de Lema 160. Alcorisa. +34 978 840 213

TOLEDO

TOLEDO_PORCELANOSA · Pol. Ind. Santa María Benquerencia, C/del Río Marchés,123. +34 925 232 402

VALENCIA

PORCELANOSA_Albuixech · Avda. del Mediterráneo, Parcela 6. Pol. ind. Mediterráneo. +34 961 417 227
SEDAVI_PORCELANOSA · Avda. Mediterráneo, s/n. Zona Comercial Sedavi. +34 963 185 021
PORCELANOSA_Valencia · Calle de Jorge Juan, 21. +34 963 530 230
PROYECTO LARA · Avinguda de la Industria, 23. Paterna. +34 960 170 078
SNC ARTESANIA EN OBRA · C. del Archiduque Carlos, 72. Valencia. +34 963 417 740. +34 963 332 236

VALLADOLID

CANTALAPIEDRA · Carretera de Soria A-24, km 5,5. Valladolid. +34 983 217 010 +34 983 200 921

VIZCAYA

BILBU_Amorebieta · Barrio Boroa, s/n. +34 946 731 158 +34 946 733 265
BILBU_Bilbao · Alameda Recalde, 39 - 41 +34 944 218 625 +34 944 218 879

ZAMORA

BENAVENTE_GONZALEZ Y GONZALEZ BERMAR S.L. · Pol. Industrial Benavente, 2. +34 980 633 484
ESSEN_Zaragoza · Muela Quebrada, 67. +34 980 521 779

ZARAGOZA

ZARAGOZA_PORCELANOSA · Parque Comercial Puerto Venecia, C/Teatro Malibrán 43 +34 976 930 800

ANDORRA - PORTUGAL - GIBRALTAR

ANDORRA

PIRINEU - PALMIR · Avda. Santa Coloma, 108. +34 376 804 020

PORTUGAL

ALMANCIL (LOULÉ)_DECORPRINCESA · +351 919 092 443 +351 289 395 752
AVEIRO_ ADRIAZUL-MATERIAIS DE CONSTRUÇÃO, LDA · +351 234 384 930 +351 234 483 815
GRANDE PORTO _PORCELANOSA PORTO S.A. · +351 226 166 600 +351 226 161 959
LISBOA _PORCELANOSA LISBOA · +351 21 831 3020 +351 21 831 3029
LOULÉ _ FRANCISCO CONTREIRAS, MATERIAS PARA CONSTRUÇÃO Lda. · +351 289 413 961
MONÇÃO _ HEITOR CAMPOS AMOEDO LDA · +351 251652474 +351 251652446
NORMACO _ MONTE REDONDO RUA DO VALE. 30. · +351 256 373 629 +351 256 365 434
PORCELANOSA MADEIRA · Caminho Santo António nº 234-A. Madeira. +351291103980
PORTIMAO _ NEPELI MATERIAIS DE CONSTRUÇÃO LDA · +351 968 577 194 +351 282 482 722
PONTA DELGADA _ FURMAT MATERIAIS DE CONSTRUÇÃO, LDA · +351 297 000 000
VISEU - PORCELANOSA VISEUT · +351 232 430 440 +351 232 430 449

PORCELANOSA Showrooms

INTERNACIONAL | INTERNATIONAL

INTERNACIONAL | INTERNATIONAL

ALEMANIA
ACHERN_ E. WERTHEIMER GMBH · +49 07841 6309 1300
ALTENSTADT AN DER WALDNAAB FLIESENHAUS LANG · +49 9602 63470
ALZEY_ J.N. KOEBIG GMBH · +49 6731 4880
ASCHAFFENBURG_ KALKWERKE · +49 (0) 60 213 601 62 +49 (0) 60 213 602 93
BAD SALZUFLEN_ W. LINNENBECKER GMBH · +49 (0) 5222 / 5301 221 +49 (0) 5222 / 5301 209
BADEN BADEN_ E. WERTHEIMER GMBH · +49 (0) 7221 50020 +49 (0)7221117080
BALLENSTEDT_ FLIESEN SCHREIBER · +49 39485 95201
BAUTZEN_ FLIESEN LEHMANN GMBH · +49 (0) 3591 / 3726 32 +49 (0) 351 / 8931420
BAYREUTH_ FLIESEN EHRLICH & CO. GMBH · +49 (0) 9 21 / 15 12 799-0
BERGISCH GLADBACH_ SCHMIDT-RUDERSDORF GMBH & CO · +49 (0) 2204 / 4007 0 771 +49 (0) 3320
BERLIN_ FLIESENPARADIES GLAESKE + SEFZIG GMBH · +49 (0) 30 650 737 0. +49 (0) 30 565 555 90
BERLIN_ KERANA KERAMIK- UND NATURSTEINHANDEL GMBH · +49 (0)30 318683-16/-19
BERLIN_ W. LINNENBECKER GMBH & CO. KG · +49 (0) 30 / 756 888 +49 (0) 30 / 756 88 756
BONN-BUSCHDORF_ SCHMIDT-RUDERSDORF- BONN · +49 02 28 - 55 916-0
BOTTROP_ W. LINNENBECKER GMBH & CO. KG · +49 (0) 2041 / 7958 13 +49 (0) 2041 / 7958 10
BRAND-ERBISDORF_ FLIESEN THOMAS GMBH · +49 (0) 37322 18 0
BREMEN_ W. LINNENBECKER GMBH & CO. KG · +49 420252190
BURG_ WIEDEMANN INDUSTRIE UND HAUSTECHNIK GMBH · +49 39163103513
BURGSTÄDT_ FLIESEN THOMAS GMBH · +49 (0) 3724 / 1856 0 +49 (0) 3724 / 1856 70
DORTMUND_ W. LINNENBECKER GMBH & CO. KG · +49 (0) 231 / 562 090 22 +49 (0) 231 / 562 090 88
DÜSSELDORF_ SCHMIDT RUDERSDORF DÜSSELDORF · +49 (0) 211 6350112
DÜSSELDORF_ SCHMIDT RUDERSDORF VIERSEN · +49 (0) 2162 816360
EISENACH_ FLIESENZENTRUM GMBH ERFURT · +49 (0) 3691 882175
EISENBERG_ J.N. KOEBIG GMBH · +49 6351 1450
EISINGEN_ FLIESENWELT EISINGEN GMBH · +49 (0) 9353 98 46 357 +49 (0) 9353 98 46 359
ELTERLEIN_ MIRKO GLEISS · +49 (0) 37349 / 7305 +49 (0) 37349 / 6093
ERFURT_ FLIESENZENTRUM GMBH ERFURT · +49 3614270720
ERKRATH_ W. LINNENBECKER GMBH · +49 (0) 211 / 92503 19 +49 (0) 211 / 92503 34
FREIBURG_ GÖTZ & MORIZ GMBH · +49 (0) 76 145 180 +49 (0) 76 145 711 2
FULDA_ OSWALD FLIESEN UND SERVICE GMBH & CO KG · +49 (0) 66 194 151 0 +49 (0) 66 194 151 40
GERA_ BAUSTOFFE GEBR.LÖFFLER GMBH · +49 (0) 365 430 701 9 +49 (0) 365 430 701 4
GERA_ FLIESEN THOMAS GMBH · +49 (0) 365 552853-0
GÖRLITZ_ FLIESEN-PEDERSEN GMBH · +49 (0) 3581 / 402809 +49 (0) 3581 / 409166
GOTHA_ FLIESENZENTRUM GMBH ERFURT · +49 (0) 3621 5144880
GÖTTINGEN_ F+B FLIESEN UND BAUSTOFF MARKT · +49 551 998710
GREIZ_ BAUSTOFFE GEBR.LÖFFLER GMBH · +49 36 61 / 70 50-0
HAMBURG - LURUP_ CROONEN FLIESENHANDEL GMBH · +49 (0) 40 / 83383 377 +49 (0) 40 / 83383 301
HANNOVER_ W. LINNENBECKER GMBH & CO. KG · +49 (0) 511 / 438 900
HEIDENAU_ FLIESEN EHRLICH & CO. GMBH · +49 (0) 35 29/ 52 85-0
HOF_ FLIESEN THOMAS GMBH · +49 (0) 9281 86005-0
HUNGEN_ MÜHL 24 · +34 (0) 6402 5200-0
JENA_ FLIESENZENTRUM GMBH ERFURT · +49 (0) 3641 - 53257-0
KIEL_ HEINRICH'S FLIESENMARKT GMBH · +49 (0) 431537340 +49 (0) 431529141
KOBLENZ_ J. N. KÖBIG GMBH KOBLENZ · +49 (0) 26 198 169 20 +49 (0) 26 198 169 10
KRANICHFELD_ MÜHL 24 KRANICHFELD · +49 (0) 36 450 330 +49 (0) 36 450 332 89
LAUF A. D. PEGNITZ_ FLIESEN EHRLICH & CO. GMBH · +49 (0) 91 23/ 97-11-0
LEIPZIG_ FLIESEN THOMAS GMBH · +49 (0) 341 308558-0
LEIPZIG_ GRAMER GMBH · +49 341 2346430
LEVERKUSEN_ SCHMIDT-RUDERSDORF- LEVERKUSEN +49 02 14 - 8 68 13 0 +49 02 14 - 8 68 13 3
LÖBNITZ_ SACHSENKERAM GBR · +49 (0) 34208 / 7400 +49 (0) 34208 / 7400
LÖRRACH_ GÖTZ & MORIZ GMBH · +49 7621 4007100
LÜBECK_ HEINRICH'S FLIESENMARKT GMBH · +49 (0) 451896669 +49 (0) 4518973494
MAINZ_ J. N. KÖBIG GMBH MAINZ · +49 061 316 943 10 +49 061 316 942 75
MAINZ_ J.N. KOEBIG GMBH · +49 6131694328
MESCHEDI_ W. LINNENBECKER GMBH & CO. KG · +49 (0) 291 / 952 82 21 +49 (0) 291 / 952 82 82
MÜNCHEN_CERAMICAS OHG · +49 (0) 89 318 280 0 +49 (0) 89 318 280 20
MÜNSTER_ W. LINNENBECKER GMBH & CO. KG · +49 (0) 251 / 979 12 21 +49 (0) 251 / 979 1220
NÜRNBERG/HAFEN_ HEINRICH CHRIST GMBH & CO. KG · +49 (0) 91 164 318 0 +49 (0) 91 164 318 50
OFFENBURG_ MAIER + KAUFMANN GMBH · +49 (0) 78196780 +49 (0)781967890
POTSDAM_ KERANA KERAMIK- UND NATURSTEINHANDEL GMBH · +49 (0) 33208 547-0 +49
PULHEIM_ SCHMIDT RUDERSDORF PULHEIM · +49 (0) 2238 839790
RADEBEUL_ FLIESEN EHRLICH & CO. GMBH · +49 (0) 351 / 89314 10 +49 (0) 351 / 89314 20
SAALFELD_ FLIESENZENTRUM GMBH ERFURT · +49 (0) 3671 52800
SCHRAMBERG_ SULGEN ARMBRUSTER GMBH · +49 (0) 7422 28008-0 +49 (0) 7422 28008-20
SCHRIESHEIM_ FLIESEN GALERIE SENGEWITZ · +49 6203 955330 +49 6203 955 33 29
SCHWARZENBERG_ FLIESEN THOMAS GMBH · +49 (0) 3774 13930 30
SPEYER_ SCHULTZ BAUZENTRUM GMBH & CO. KG · +49 6232/ 64620 +49 6232/ 646250
STEINACH_ MAIER + KAUFMANN GMBH · +49 (0)7832 - 796 0
TRIER_ SCHOLTES HANDELS GMBH · +49 651 9186611
UNTERGRUPPENBACH_ KONZ & SCHAEFER HANDEL GMBH · +49 (0) 71312037480 +49 (0) 71312037489
VÖLKLINGEN_ NIEDERER GMBH +49 (0) 68 989 802 21 +49 (0) 68 989 802 30
WAIBLINGEN_ KONZ GMBH · +49 (0) 7151149200 +49 (0) 710510149-209
WÜRSELEN_ SCHMIDT-RUDERSDORF- WÜRSELEN · +49 (0) 24 05 - 41 38 50 +49 (0) 24 05 - 41 38 55
ZWETHAU_ GRAMER GMBH · +49 (0) 3421 / 7327 18 +49 (0) 3421 / 7326 73

ALBANIA
TIRANA_ALBA CERAMICA PORCELANOSA GRUPO · +355 4 22 33 817 +355 4 22 33 817

ARABIA SAUDÍ
DAMMAM_MANART AL ANDALOS DAMMAM · (+)966 12 6768441
DAMMAM_MOHAMMED M. AL DOSSARY STORES · 38348681 38340086
HAFUF_MANART AL ANDALOS AL AHSÄ · (+)966118102824
JEDDAH_MANART AL ANDALOS JEDDAH · (+)966 12 6768443 (+)966 12 6768440
JEDDAH_MANART AL ANDALOS JEDDAH · (+)966 12 6768443
RIYADH_MANART AL ANDALOS RIYADH · (+)966 11 8102512
RIYADH_MANART AL ANDALOS RIYADH · (+)966 11 4568383
RIYADH_MOHAMMED M. AL DOSSARY STORES CO · (0)114884006

ARGELIA
ALGER_NOVACASA · +213 21 55 07 37 +213 23 94 74 46
ORAN_PORCELANOSA ORAN · 14237002361

ARGENTINA
C.A.B.A_ALTEA PALERMO · +54 11 4776 3768
C.A.B.A_ALTEA FLORESTA · +54 11 4671 2007
C.A.B.A_BLAISTEN - BARRACAS · +54 11 4302-0202
C.A.B.A_BLAISTEN - PALERMO · +54 11 4772-4800
C.A.B.A_BLAISTEN S.A. - FLORESTA · +54 11 44016-2400
C.A.B.A_PORCELANOSA BUENOS AIRES · +54 11 4776 3008
CASTELAR_BLAISTEN S.A. - CASTELAR · +54 11 4450-0071
MARTÍNEZ_BLAISTEN - MARTÍNEZ · +54 11 4717-3300
MENDOZA_HIPERCERAMICO · +54 0261 4373000
NEUQUEN_CARLOS ISLA · +54 0299-4440090
PILAR_BLAISTEN - PILAR · +54 11 0230-4474051
ROSARIO_BALCARCE 54 FISHERTON · +54 341 5284970
ROSARIO_BALCARCE 54 CENTRO · +54 341 528-4950
SAN JUSTO_BLAISTEN - SAN JUSTO · +54 11 4484-9447/8

ARMENIA
YEREVAN_SACO & ARARAT-SALON BOMOND · +37 410 55 08 99 +37 410 50 05 50

ARUBA
ORNAJESTAAD_BANJOLUX · +297 588 0565

AUSTRALIA
BRISBANE_EARP BROTHERS · +61 7 3088 8999
HOBART_ROSSETTO TILING · +61 3 6231 2931
LAUNCESTON_ROSSETTO TILING · +61 3 6326 4955
MELBOURNE_EARP BROTHERS · +61 3 9328 9588
NEWCASTLE_EARP BROS TILE - NEWCASTLE · +61 2 4962 5500
OSBORNE PARK_CERAMO · +61 8 9445 1777
SYDNEY_EARP BROTHERS · +61 2 9410 3222

AUSTRIA
ANSFELDEN_BEINKOFER · +43 (0) 7229 78525 +43 (0) 7229 88818 - 50
BRUCK/MUR_TENNE BRUCK · +43 3862 588 44 +43 3862 588 44-22
GRAZ_FLIESEN TENNE · +43 316 262 524 0 +43 316 262 524 22
HALL_BEINKOFER BEI HOLTER · +43 (0) 5223 5046910 +43 (0) 5223 5046919
INNSBRUCK_FLIESENTENNE TIROL INNSBRUCK · +43 5 0780 23020
INNSBRUCK_FLIESEN CENTER TIROL · +43 (0) 512 364444
LEIBNITZ_TENNE LIBNITZ KINDERMANN BAD & HEIZTECHNIK · +43 3452 707-65 +43 3452 707-29
LINZ_BEINKOFER · +43 732 776 543 0 +43 732 776 543 60
LINZ_BEINKOFER · +43 (0) 732 6552550 +43 (0) 732 65525520
SALZBURG_BEINKOFER BEI HOLTER · +43 (0) 662 469096920 +43 (0) 662 469094289
VÖSENDORF_TENNE VÖSENDORF · +43 1 699 33 33 +43 1 699 33 33-22
WELS_BEINKOFER BEI HOLTER · +43 (0) 7242 25253210 +43 (0) 7242 25253250
WIEN_BEINKOFER · +43 (0) 50 483-6940
WIEN_BEINKOFER BEI HOLTER · +43 (0) 1 61516006900 +43 (0) 1 61516006909
WIEN_BEINKOFER GMBH · +43 50 483 6950
WIEN_TENNE WIEN 22 BADKULT-NORT · +43 1 20 20 520 +43 1 20 20 520-20
WIEN_BEINKOFER BEI BÄDERPARADIES · +43 (0) 1 522422200 +43 (0) 1 5224222020

AZERBAIYÁN
BAKU_AKSESUAR INSAAT · +994 12 546 74 86 +994 12 546 74 86

BAHRÁIN
SITRA_CERAMIC GALLERY SPC · 33076526
MANAMA_AL ABBAS GALLERY · +973 741 919 +973 741 747

BANGLADESH
PORCELANOSA_DHAKA · +880 1793 567404

BARBADOS
BRIDGETOWN_KEYSTONE PRODUCTS · +1 246-418-8453

BÉLGICA
BEKKEVOORT_GEDIMAT HENDRICKX · +32 13 31 15 58
Diksmuide_BOUWMATERIALEN VINCKIER · +32 51 50 00 67
Geel_GAVRA ceramics & surfaces · +32 14 56 29 27
Heist-op-den-Berg_PGB CERAMICA BVBA · +32 15 25 33 66
LIER_STEYLAERTS LIER · +32 34 82 13 53
Lommel_VANGENEUGDEN VTK · +32 11 55 33 11
Maasmechelen_4D TEGELIMPORT · +32 89 76 44 26
Merelbeke_Tegelbedrijf De Ganck · +32 92 30 57 30
ST. VITH_CASA DE LA PIETRA · +32 80 22 11 68
TEMSE_STEYLAERTS TEMSE · +32 37 11 04 04
Tessenderlo_KAREL WILLEMS NV · +32 13 66 20 04
Villers-le-Bouillet_SCHELFHOUT BELGIUM CARRELAGES - TEGELS · +32 42 28 28 00
WATERLOO_QUADRUS WATERLOO · +32 23 58 34 48
WAVRE_QUADRUS WAVRE · +32 10 40 14 03
Wevelgem_Tegels Depaepe · +32 56 43 27 43
WIJNEGEM_AZULEO · +32 33 27 99 77
ZAVENTEM_QUADRUS ZAVENTEM · +32 27 20 78 09

BENÍN
Cotonou_Cid Super Decor · 00229 97 12 23 26

BERMUDAS
PEMBROKE_PEMBROKE TILE & STONE CO. LTD · +441 292 8453 +441 295 8453

BOSNIA-HERZEGOVINA
BIJELJINA_LUK D.O.O. · +387 55 228 100 +387 55 228 101
CITLUK_BROTIS D.O.O. · +387 36 650 960 +387 36 650 950
SARAJEVO_LUK D.O.O. · +387 33 777 888 +387 33 777 889

BRASIL
CURITIBA_PORCEBRAS · +55 (41) 3392 1500 +55 (41) 3392 1400

PORCELANOSA Showrooms

INTERNACIONAL | INTERNATIONAL

INTERNACIONAL | INTERNATIONAL

BULGARIA
BURGAS_ELE CERAMICA · +359 56 842 849
SOFIA_ART GRESS LTD · +359 2 855 22 59
SOFIA_ELE CERAMICA · +359 28 606 060
VARNA_ELE CERAMICA · +359 52 500 555

BURKINA FASO
OUAGADOUGOU_HAGE MATERIAUX · 25 30 68 28/33

CAMERÛN
DOUALA_CONNECTIK HALL SAS · 237233434780

CANADÁ
BRAMPTON_PORCELANOSA EAST CANADA · P: (+1) 9.054.541.053 F: (+1) 905.454.1055
CALGARY_PORCELANOSA CALGARY · (587) 349-2290
TORONTO_PORCELANOSA TORONTO · 9054541053
VANCOUVER_FONTILE DISTRIBUTORS · +604 683 9358 +604 683 6758

CHILE
SANTIAGO_PORCELANOSA CHILE · (56 2) 2 434 92 87

CHINA
SHANGHAI_PORCELANOSA SHANGHAI · +86 21 61397952

CHIPRE
GIRNE_MEPAS LTD · 9039 2815 2964 9039 2815 5651
LIMASSOL_THE ENGINEERING AND COMMERCIAL ASSOCIATION (EKA) · +357 25854444 +357 25854545

CISJORDANIA
BETHLEHEM ST.WEST BANK_AL-KHAYAL (BAYTOUNA) · +972 2 277 7279

COLOMBIA
BOGOTÁ_PORCELANOSA BOGOTÁ · +57 743 0209
MEDELLÍN_PORCELANOSA MEDELLÍN · +57(4) 322 5297

COREA DEL SUR
BUSAN_COTTO CERAMIC CO LTD · 82512080022 82512088558
SEO-GU_COTTO CERAMIC CO LTD · 82325840770
SEOUL_BARRO CERAMIC · 82234438600 82234438822
SEOUL_HANSEM NEXUS · 82246704950

COSTA DE MARFIL
ABIDJAN_FADCO COMPANY · +225 21757355 +225 21757358

COSTA RICA
SAN JOSÉ_FERNANDEZ AGUILAR S.A. · +506 222 5674 +506 221 9952

CROACIA
DUBROVNIK_OTP DUBROVNIK · +385 20 412478
POREC_SPINA · +385 52 451 348
PULA_SPINA · +385 52 219 002
RUEKA_SPINA · +385 51 741 300
SPLIT_SPINA · +385 21 668 991
VARAZDIN_SPINA · +385 42 303 707
ZAGREB_SPINA · +385 13 492 552
ZAGREB_ABC INTERIJER · +385 16 393 164 +385 16 055 985
ZAGREB_SPINA · +385 13 492 552

DINAMARCA
GLOSTRUP_MOSAIKHJORNET · +45 43 633 900
HERLEV_PORCELANOSA DINAMARCA · 4539563007
AARHUS_DOKK16 A/S · +45 31 12 00 99

ECUADOR
CUENCA_GRIFINE HOME CENTER S.A · (593) 07 281-8089
GUAYAQUIL_GRIFINE HOME CENTER S.A · (593)4 370-2830
QUITO_GRIFINE HOME CENTER S.A · (593) 2 393-1920

EE.UU.
GILSA NORTH AMERICA · +1 956 223 2900
PORCELANOSA ANAHEIM · +1 714 772 3183
PORCELANOSA ATLANTA · 404 973 0640
PORCELANOSA BOSTON - BOSTON DESIGN CENTER · +1 617-963-7666
PORCELANOSA BROOKLYN · +1 929-239-3260
PORCELANOSA CHESNUT HILL · 6179637666
PORCELANOSA CHICAGO · +1 312 204 6220
PORCELANOSA DALLAS · +1 214 377 2327
PORCELANOSA DENVER · 303 802 3210
PORCELANOSA EAST BRUNSWICK · +1 732 613 1915
GLENDALE TILE · +1 818 500 8505
AMIRIAN HOME · +1 424 390 4460
Porcelanosa King of Prussia · 14847510050
PORCELANOSA MIAMI · +1 305 715 7153
PORCELANOSA MIAMI DESIGN DISTRICT · 001 786 329 6753
PORCELANOSA MANHATTAN FLAGSHIP STORE · 16467511180
PORCELANOSA ROCKVILLE · +1 240 290 1120
PORCELANOSA PARAMUS · +1 201 712 0556
PORCELANOSA POMPANO BEACH · +1 954 968 7666
PORCELANOSA RAMSEY · +1 201 995 1310
PORCELANOSA RIVERSIDE · +1 203 698 7618
PORCELANOSA SAN DIEGO · +1 858 322 6012
PORCELANOSA SAN FRANCISCO · +1 415 593 7763
PORCELANOSA SAN JOSE · +1 408 467 9400
PORCELANOSA SEATTLE · 2066738395
PORCELANSOA WALNUT CREEK · +1 925 952 7430
PORCELANOSA WASHINGTON DC · 12022041655
PORCELANOSA WEST HOLLYWOOD · +1 310-300-2090
PORCELANOSA WESTBURY · +1 516 338 0097

EGIPTO
EL CAIRO_MAHGOUB TRADING & IMPORTING · +20 2 57 12 565 +20 2 57 39 344

EL SALVADOR
SAN SALVADOR_FERRETERÍA DE LA CONSTRUCCIÓN · FERCO · (503) 2510 8888 (503) 2510 8810

EMIRATOS ÁRABES
DUBAI_PORCELANOSA ASSOCIATE DUBAI · (+ 971) 43 35 38 88
DUBAI_PORCELANOSA DUBAI · (+971) 43 35 38

ESLOVAQUIA
BRATISLAVA_CERSA · 421244442833
KOSICE_VODOARM · (055) 6222660 (055) 6222654
KOSICE_ELKEM SRO KOSICE · 421557281615, 421557281617
TOPOLCANY_REHAK SRO · 421905553555

ESLOVENIA
LIUBLJANA_ŠMARTINSKA CESTA 52, ABC INTERIJER DOO (SI) · 38670579223

ESTONIA
TALLINN_HOME CONCEPT PORCELANOSA · 3726005045
TALLINN_PLAADIPUNKT · +372 650 0720 +372 650 0723

ETIOPÍA
ADDIS ABABA_J SALE TRADING · +251 (0)911 20 53 91 +251 (0)930 03 45 51

FILIPINAS
CEBU_CASA EUROPA · +63 2 519 3515
MANILA_CASA EUROPA INC · +63 32 272 8180
VANTAA_LAATTAPISTE OY · +358 9 878031

FRANCIA
AJACCIO_PORCELANOSA AJACCIO - ART & STYLES · 04 95 22 19 99
ANNECY_PORCELANOSA ANNECY · 04 38 80 09 90
ARCUEIL_PORCELANOSA PORTE D'ORLÉANS · 01 49 12 12 57
AUBAGNE_PORCELANOSA MARSEILLE · 04 42 62 43 30
AUGNY_PORCELANOSA METZ · 03 72 72 97 40
BEAUCOUZÉ_PORCELANOSA ANGERS · 02 41 73 81 00
BESANÇON_PORCELANOSA BESANÇON · 03 81 41 63 63
BIGUGLIA_PORCELANOSA BASTIA - ART & STYLES · 04 95 58 98 98
BREST_PORCELANOSA BREST · 02 98 02 51 00
CABESTANY_PORCELANOSA PERPIGNAN · 04 68 29 76 20
CHAMBRAY-LÈS-TOURS_PORCELANOSA TOURS · 02 47 80 87 87
CHAMPAGNE AU MONT D'OR_DÉPÔT PORCELANOSA LYON · 04 78 66 81 56
CHAMPAGNE-AU-MONT-D'OR_PORCELANOSA LYON · 04 78 66 81 51
CHASSENEUIL-DU-POITOU_PORCELANOSA POITIERS · 05 49 11 97 87
COIGNIÈRES_PORCELANOSA COIGNIÈRES · 01 30 49 12 80
FLEURY-LÈS-ABRAIS_PORCELANOSA ORLÉANS - MILESPPACES · 02 38 42 15 38
FONTENAY-SUR-EURE_PORCELANOSA CHARTRES - EMOTIONS CARRELAGE · 02 42 25 25 25
GUÉRANDÉ_PORCELANOSA LA BAULE · 02 40 60 72 73
LA CHAPELLE-SAINT-AUBIN_PORCELANOSA LE MANS · 02 43 23 65 20
LA GARDE_PORCELANOSA ASSOCIATE TOULON · (+33) (0)4.83.73.88.65
LA ROCHE-SUR-YON_PORCELANOSA LA ROCHE-SUR-YON 02 51 24 12 17
LA TESTE DE BUCH_PORCELANOSA ARCACHON - SOLS ET BAINS DE LA DUNE · 05 57 15 64 42
LE HAVRE_PORCELANOSA LE HAVRE - LAURENT DUQUESNE · 02 35 54 21 30
LEZENNES_PORCELANOSA LILLE · 03 20 34 03 40
LIBOURNE_THAIS DECORATION · 05 57 74 47 60
LIEUSAINT_SIÈGE PORCELANOSA FRANCE · 01 69 90 90 90
LORIENT_PORCELANOSA LORIENT · 02 97 87 50 00
LYON_PORCELANOSA LYON CENTRE · 04 37 42 05 00
MANDELIEU-LA-NAPOULE_PORCELANOSA CANNES · 04 93 47 73 60
MEAUX_PORCELANOSA MEAUX · 01 60 09 28 28
MÉRIGNAC_PORCELANOSA BORDEAUX · 05 56 12 48 48
MONDEVILLE_PORCELANOSA CAEN · 02 31 82 00 00
MONTIGNY-LÈS-CORMELLES_PORCELANOSA MONTIGNY · 01 39 31 19 79
NANTERRE_TRIOMPHE · 01 47 73 92 82
NÎMES_PORCELANOSA NÎMES · 04 66 28 27 80
ORVAULT_PORCELANOSA NANTES · 02 28 07 39 50
PARIS_PORCELANOSA BUREAUX TECHINCO-COMMERCIAL PARIS · 01 44 90 85 70
PARIS_PORCELANOSA PARIS · 01 42 84 84 00
PÉROLS_PORCELANOSA MONTPELLIER · 04 67

PORCELANOSA Showrooms

INTERNACIONAL | INTERNATIONAL

| |
|---|
| GEORGIA |
| TBILISI_LUXOR SHOP · +995 32 2388898 +995 32 2388399 |
| GIBRALTAR |
| GIBRALTAR_LIFESTYLE DESIGN STUDIO LTD · 35020066390 |
| GRECIA |
| ATTICA_SUERO · +30 2105 594 520 +30 2105 594 521 |
| THESSALONIKI_PORCELANA · 2310 700 861 2310 700 861 |
| GUADALUPE |
| BAIE MAHAULT_GUADELOUPE CERAMIQUE · +590 266 261 +590 266 412 |
| SAINT BARTHELEMY_ALMA QUINCAILLERIE · +590 276 494 +590 276 738 |

| |
|--|
| GUATEMALA |
| CIUDAD DE GUATEMALA_BOULEVARD DESIGN (DISTRIBUIDORA MARISCAL) · +502 2337 2772 |
| QUETZALTENANGO, DEPQUETZALTENANGO_CERAMICAS CASTELLI · 50245691346 |

| |
|--|
| GUINEA |
| CONAKRY_PORCELANOSA CONAKRY · 00224 629 29 00 12 |

| |
|---|
| HAÍTÍ |
| PORT AU PRINCE_EURO CERAM · 0 999 999 984 |

| |
|--|
| HONDURAS |
| SAN PEDRO SULA_CENTRO DE CERÁMICAS · 50425567780 |

| |
|---|
| HONG KONG |
| KOWLOON_TAI YICK BUILDING MATERIALS · +852 23 956 670 +852 23 957 831 |

| |
|---|
| HUNGRÍA |
| BÉKÉSCSABA_PALATINUS FURDOSZOBASZALONOK · +36 66 328 432 +36 66 328 432 |
| BUDAPEST_AXOR HOME KFT · +36 1 2370878 +36 1 2370879 |
| BUDAPEST_MIRAGE 86 ZRT · +36 1 793 9532 +36 1 799 6289 |
| BUDAPEST_PALATINUS FURDOSZOBASZALONOK · +36 1 430 04 17 +36 1 387 91 36 |
| DREBECEN_PALATINUS FURDOSZOBASZALONOK · +36 3 031 94 353 +36 52 536 822 |
| EGER_PALATINUS FÜRDŐSZOBASZALON EGER · +36 3681 4319 +36 3631 0575 |
| EGER_PALATINUS FURDOSZOBASZALONOK · +36 0636 312 013 +36 0636 313 270 |
| ÉRD M7-ES FELJÁRÓ_VS FÜRDŐSZOBA ÉRD · +36 304 831 154 |
| GYÖNGYÖS_PALATINUS FURDOSZOBASZALONOK · +36 37 500 162 +36 37 500 163 |
| KECSKEMÉT_PALATINUS FÜRDŐSZOBASZALON KECSKEMÉT · +367607918 |
| MAGYAR_VS RBC - RAVAK BUSINESS CENTER · +36 304831154 |
| MISKOLC_PALATINUS FURDOSZOBASZALONOK · +36 46 412 741 +36 46 416 256 |
| NYIREGYHÁZA_KOVÁCS TÚZÉP CT · VIDA ERZSÉBETCCC · +36 42 598 073 |
| TARJÁN_STRAUBINGER ÉPÍTÉSI VÁLLALKOZÓ KFT. · +36 303 483 773 |

| |
|--|
| INDIA |
| NEW DELHI_AARAV MARKETING · +91 9999910667 |
| NEW DELHI_MARMO HOME PVT. LTD. · +91 11 47128800 +91 11 23218728 |

| |
|--|
| INDONESIA |
| BANDUNG_WISMA SEHATI (BANDUNG) · +62 22 723 8515 +62 22 723 8516 |
| JAKARTA_WISMA SEHATI (BSD) · +62 21 537 7278 +62 21 537 7880 |
| JAKARTA_WISMA SEHATI (MANGGA DUA) · +62 21 6013303 +62 21 6251221 |
| JAKARTA_WISMA SEHATI (POLIM) · +62 21 72787711 |
| SEMARANG_WISMA SEHATI (SEMARANG) · +62 24 356 2233 +62 24 356 2222 |
| SURABAYA_WISMA SEHATI · +62 31 5631999 |

| |
|--|
| IRAQ |
| BAGHDAD_BAGHDAD TIME COMPANY LTD · +964 771 111 1594 +964 771 186 2730 |
| ERBIL_AKSEUAR INSAAT ERBIL · +964 750 835 0055 +964 66 210 1900 |

| |
|--|
| IRLANDA |
| CORK_O.B. HEATING, PLUMBING, BATHROOMS & TILES · +353 0 214 310 000 +353 0 214 310 003 |
| DUBLIN_TILESTYLE LTD · +00 353 1 8555200 +00 353 1 8557471 |
| WATERFORD_BEST TILE · 0035351 354905 |
| RATHNEW_MILLER BROS STONE DEVELOPMENT · +353 0404 32222 |

| |
|---|
| ISLAS TURCAS Y CAICOS |
| PROVIDENCIALES_SOLUTION EXPERTS LTD · +1 6493318833 |

| |
|---|
| ISRAEL |
| BEIT SHEMESH_VMB HACERAMICA LTD · +972 50-549-8311 |
| HAIFA_TOPOLSKI & CO LTD · +972 4 904 0496 +972 4 904 0455 |
| JERUSALEM_BAR-AMI 1990 LTD · +972 2 531 3444 +972 2 538 3740 |
| KANOT_POLINOY · +972 5 277 73437 |
| RAANANA_AMOZI NAGAR IMP.MARK.OGEN LTD · +972 9 760 1501 +972 9 741 1997 |
| SAKHNIN_DOUKHI · +972 4 674 9666 |
| ROSH HAINI_BACERAMIC DESIGN · +972 3 603 0111 +972 3 907 1992 |
| UPPER GALILY_KAMARIKA · +972 4 680 1010 +972 4 680 0318 |

| |
|---|
| ITALIA |
| AREZZO_GIORNI HOME · 0575/1696076 |
| BADESSE_GRUPPO ARKELL - BADESSE · 0577/309058 |
| BELLUNO_PORCELANOSA BELLUNO · 328 9078586 |
| BERGAMO_PORCELANOSA BERGAMO · 39035299984 |
| CORSICO_PORCELANOSA LOMBARDIA · +39 02 458 64310 |
| ELMAS_PORCELANOSA CAGLIARI · 702110009 |
| GROSSETO_GRUPPO ARKELL - GROSSETO · 0565/1768367 |
| MILANO_PORCELANOSA MILANO · 0039 02 726 839 11 |
| POSTALESIO_VDM · 0342 590077 |
| ROMA_PORCELANOSA ROMA · +39 06 888 9977 |
| SARMATO_GARBI CERAMICHE · 0523 887427 |
| SASSARI_PORCELANOSA SASSARI · 070 211 0009 |
| SASSUOLO_PORCELANOSA · +39 05 368 06677 |
| TREVISO_PORCELANOSA TREVISO · 0422 697 087 |
| VIA SENESE ARETINA N. 120_GIORNI ALDO · 0575/749836 |

| |
|--|
| JAMAICA |
| FERRY_TILE CITY & HOME CENTRE · +1 876-466-7862 |
| KINGSTON_TILE CITY & HOME CENTRE · +1 876 925 8453 |

| |
|---|
| JAPÓN |
| OSAKA_YOSHIMOTO TRADING CO.LTD · 0081-72-967-2001 |
| TOKYO_YOSHIMOTO TRADING CO.LTD · +072 334341700 |

| |
|--|
| JERSEY |
| ST. SAVIOUR_PASTELLA GROUP · 01534 870167 01534 723199 |

| |
|--|
| JORDANIA |
| AMMAN_AYMAN ABDALLAT & PARTNERS CO. ·9002 956197 5504523 |

| |
|------------------------------------|
| KAZAJISTÁN |
| ALAMTY_DOMINA · +7 (727) 275 50 36 |
| ASTANA_DOMINA · +7 (7172) 76 97 61 |

| |
|--|
| KENIA |
| NAIROBI_LIFESTYLE INTERIORS LTD · 254713380549 |

| |
|---|
| KOSOVO |
| PRISHTINÉ_N P KERASAN · +381 38 602 667 +381 38 602 667 |

| |
|--|
| KUWAIT |
| Al Rai Al-Sinayia_HASSAN ABUL · +965 24762953 |
| SAFAT_HASSAN ABUL HASSAN SADIQ · +965 262 4466 +965 265 1444 |

| |
|---|
| LETONIA |
| RIGA_TORMANIS UN PARTNERI · +371 784 5361 +371 784 5360 |

| |
|---|
| LÍBANO |
| BEIRUT_GEAHCHAN GROUP · +961 1 480520 +961 1 496607 |
| BEIRUT_PORCELANOSA GROUP BEIRUT · +961 1881170 |

| |
|--|
| LIBIA |
| BENGHAZI_EL RAGUOBI · 218 61 4704533 218 61 2237328 |
| BERKA BENHAZI_MANART AL ANDALOS EST · 21861229605 218612237328 |
| TRIPOLI_EL RAGUOBI · 218 91 3274885 |

| |
|--|
| LITUANIA |
| VILNIUS_INTERJO SALA - JSC VENDE · 370 6 8711071 |
| VILNIUS_OGRINDA UAB · 370 5 2607854 |
| VILNIUS_OGRINDA UAB · 370 5 2715519 |

| |
|--|
| MACEDONIA |
| SKOPIJE_TE LINDI DOO · +389 2 2 602 628 +389 2 2 602 638 |

| |
|-------------------|
| MADAGASCAR |
| SKOPIJ |

| |
|---|
| MALASIA |
| ALOR SETAR_APEX BOUTIQUE - SELANGOR · +603 7875 7833 |
| KOLOMBONG,KOTA KINABALU_APEX BOUTIQUE – KOTA KINABALU · +6088 388 150 +6088 389 150 |
| KUALA LUMPUR_APEX BOUTIQUE - KUALA LUMPUR · +603 4043 8333 +603 4044 3338 |
| PENANG_APEX BOUTIQUE – PENANG · +604 659 3322 +604 659 3339 |
| PETALING JAYA_APEX BOUTIQUE - SELANGOR · +603 7875 7833 +603 7876 7833 |
| PETALING JAYA_PORCELANOSA KUALA LUMPUR · +603 7865 8817 +603 7865 7730 |
| SEBERANG PRAI TENGAH_APEX BOUTIQUE - BUTTERWORTH · +604 3988 333 +604 3988 987 |

| |
|---|
| MALTA |
| BIRKIRKARA_ROGER SATARIANO & SONS LTD · +356 21 442 769 +356 21 497 017 |

| |
|---|
| MARRUECOS |
| CASABLANCA_CERAMEX · +212 945 3646166 +212 5223 395363 |
| CASABLANCA_SANITAIRE 2000 · +212 22 363 225 +212 22 394 100 |
| TANGER_FACENOR S.A. · +212 39 941 910 +212 39 945 445 |

| |
|---|
| MARTINICA |
| LAMENTIN_JOSEPH COTTRELL S.A. · +596 509 810 +596 506 524 |

| |
|---|
| MÉXICO |
| PORCELANOSA MÉXICO - SHOWROOM ALTAVISTA · (55) 5550 7060 |
| PORCELANOSA MÉXICO - SHOWROOM ARTZ PEDREGAL · 5552068233 |
| PORCELANOSA MÉXICO - SHOWROOM GUADALAJARA · (33) 3615 3255 |
| PORCELANOSA MÉXICO - SHOWROOM INTERLOMAS · +(55) 3605 0064 |
| PORCELANOSA MÉXICO - SHOWROOM MASARYK · (55) 528220 00 |
| PORCELANOSA MÉXICO - SHOWROOM PLAYA DEL CARMEN · (984) 873 1090 |
| PORCELANOSA MÉXICO - SHOWROOM LOS CABOS · (62)41528387 |
| PORCELANOSA MÉXICO - SHOWROOM VALLE DORADO · (55) 5831 7340 |
| PORCELANOSA MÉXICO - SHOWROOM CANCÚN · +(99) 8313 2343 |

| |
|--|
| MOLDAVIA |
| CHIȘNĂU_MAC-STRO SRL · +373 691 26 833 |

| |
|--|
| MÓNACO |
| MONACO_PORCELANOSA MONACO · +377 93 50 23 87 |

| |
|--|
| MONGOLIA |
| ULAANBAATAR_ZUUNNAIMAN SUVRAGA CO.LTD · +976 (11) 3414 217 |

| |
|--------------------------------|
| MONTENEGRO |
| PODGORICA_ENTEXT · 38220260833 |

| |
|---|
| MYANMAR |
| YANGON_PORCELANOSA ASSOCIATE MYANMAR · (+95) 9956988932 |

PORCELANOSA Showrooms

INTERNACIONAL | INTERNATIONAL

| |
|---|
| NEPAL |
| KATMANDU_RUKMANI INTERNATIONAL PVT LTD · 97714420281 97714428295 |
| NICARAGUA |
| MANAGUA_DECO CENTER - GRUPO IBERICA NICARAGUA · +505 270 2121 +505 277 0834 |
| NIGERIA |
| VICTORIA ISLAND, LAGOS_PORCELANOSA LAGOS · +234 8090371913 |
| NORUEGA |
| ÅLESUND_FAGFLIS ÅLESUND · +47 70 10 22 64 |
| BODØ_FAGFLIS BODØ · +47 75 52 25 57 |
| BÆRUM_FAGFLIS BÆRUM · +47 67 10 34 90 |
| BERGEN_FAGFLIS BERGEN · +47 55 11 77 40 |
| DRØBAK_FAGFLIS DRØBAK · +47 64 93 96 76 |
| ELVERUM_FAGFLIS ELVERUM · +47 62 41 67 60 |
| FREDRIKSTAD_FAGFLIS FREDRIKSTAD · +47 69 31 70 00 |
| GJØVIK_FAGFLIS GJØVIK · +47 61 18 80 86 |
| GURSKØY_FAGFLIS SØRE SUNNMØRE · +47 70 10 22 77 |
| HAMAR_FAGFLIS HAMAR · +47 62 59 70 00 |
| KLØFTA_FAGFLIS KLØFTA · +47 63 98 29 20 |
| KRISTIANSUND_N_FAGFLIS KRISTIANSUND · +47 70 10 22 76 |
| LARVIK_FAGFLIS LARVIK · +47969 15 027 |
| LIERSKOGEN_FAGFLIS LIERTOPPEN · +47 31 00 02 80 |
| MOLDE_FAGFLIS MOLDE · +47 70 10 22 74 |
| MOSS_FAGFLIS MOSS · +47 69 24 15 70 |
| NARVIK - ANKENESSTRAND_FAGFLIS NARVIK · +47 76 95 04 90 |
| NESTTUN_FAGFLIS BERGEN · +47 55 11 77 40 +47 55 11 77 49 |
| OPPDAL_FAGFLIS OPPDAL · +47 72 42 23 50 |
| OSLO_FAGFLIS ARKITEKTSHOWROOM · +47 22 80 85 60 |
| OSLO_FAGFLIS OSLO · +47 22 80 18 00 +47 22 80 18 01 |
| SANDEFJORD_FAGFLIS SANDEFJORD · +47 47 24 62 00 |
| SANDNES_FAGFLIS SANDNES · +47 51 63 15 36 |
| SKIEN_FAGFLIS GRENLAND · +47 35 58 70 00 |
| TØNSBERG_FAGFLIS TØNSBERG · +47 33 35 81 60 |

| |
|--|
| NUEVA ZELANDA |
| AUCKLAND_159 DESIGN · 6437414991Ç |
| CHRISTCHURCH_NEXT DORE · 6433669400 |
| CHRISTCHURCH_NEXT DORE · 03 366 9400 |
| WELLINGTON_THE WELLINGTON DESIGN LIBRARY · +64 3 741 4991 |
| PAÍSES BAJOS |
| ALMERE_G.J. MEIJER SANITAIR EN TEGELS B.V. · 036-5371694 |
| AMERSFOORT_BOUWCENTER FILIPPO AMERSFOORT · 0031 33 461 6946 |
| AMSTERDAM_PORCELANOSA ARCHITECTEN SHOWROOM · 0031 20 7372845 |
| AMSTERDAM_WOUT’S TEGELHANDEL · 020-6841155 |
| APELDOORN_WASSINK BINNENVOEREN · 0031 55 522 53 02 |
| BARENDRECHT_TEGELHUIS BADKAMERS EN TEGELS · 0180-646810 |
| BERGEN OP ZOOM_BOUWCENTER LOGUS BERGEN OP ZOOMS · 0031 164 271 500 |
| BERGSCHENHOEK_WOONING KEUKENS & BADKAMERS - BERGSCHENHOEK · 0031 10 524 2300 |
| BOVEN-LEEUWEN_JON TOEBAST TEGELS SANITAIR & BOUWPRODUCTENV0031 487 592 606 |
| BOXTEL_HARRY VAN DER VELDEN · 0031 411 672 097 |
| CAPELLE AAN DEN IJSSEL_BRUGMAN KEUKENS & BADKAMERS CAPELLE · 0031 10 258 7555 |
| DE MEERN_KOEDAM TEGELS · 030-6662525 |
| DEN HAAG_HARRY SUIKER DE TEGEL - EN BADKAMERSPECIALIST · 0031 70 367 2329 |
| DEVENTER_BOUWCENTER FILIPPO DEVENTER · 0031 570 622 525 |
| ENSCHDEDE_KOOPMAN PERSONAL DESIGN · 0031 53-4304273 |
| ERMELO_BOUWCENTER FILIPPO ERMELO · 0031 341 371 040 |
| GEMERT_VAN HEUGTEN BADDESIGN EN INSTALLATIE · 0031 492 365 632 |
| GOUDA_VAN MUNSTER BADKAMERS · 0031 182 555 999 |
| GRÖNINGEN_BADERIE WATER EN VUUR - BADKAMERS EN HAARDEN · 0031 50 528 0827 |
| HEERHUGOWAARD_SANITAIR EN KEUKENHUIS · 072-5714050 |
| HENGEL0_AART VAN DE POL · 0031 74 249 1044 |
| HOOGEVEEN_TEGELS & SANITAIR HOOGEVEEN · 0031 528 271 120 |
| KAATSHEUVEL_JAC KLIJN BOUWMATERIALEN · 0031 416 280 055 |
| KATWIJK AAN ZEE_BOUWTON · 0031 71 408 2525 |
| MARIE CURIEWEG 9-13_BOUWCENTER LOGUS VLISSINGEN · 0031 118 690 025 |
| MEPPEL_BOUWCENTER CONCORDIA MEPPEL · 0031 522 253631 |
| MIDDELHARNIS_BOUWCENTER ESSELINK MIDDELHARNIS · 0031 187 475 400 |
| NIJKERK_STIJL BADKAMERS · 0031 33 207 8989Ç |
| NIJVERDAL_LAURENS BADKAMERS · 003 1548 618 675 |
| NUENEN_BADERIE NUENEN · 0031 40 782 0848 |
| NUMANSDORP_TEGELHANDEL NUMANSDORP B.V. · 0031 186 655 999 |
| ROTTERDAM_WOONING KEUKENS & BADKAMERS - ROTTERDAM · 0031 10-4791944 |
| SINT-MICHIËLSGESTEL_VAN BOVEN EXCLUSIEVE KEUKENS EN BADKAMERS · 0031733 594 1427 |
| SINT-OEDENRODE_BADERIE VOSS NIJNSEL · 0031 413 472 184 |
| SOMEREN_BADERIE SOMEREN BV · 0031493-441177 |
| SOMMELSDIJK_TEGELHANDEL RIEN PEEMAN · 0187-486192 |
| SURHUISTERVEEN_SK TEGELS & SANITAIR · 0031 (0) 512 360 358 |
| TERNEUZEN_BOUWCENTER LOGUS DE HOOP TERNEUZEN · 0031 115 680 612 |
| UDEN_VERWIJST BADKAMERS, TEGELS EN SANITAIR · 0031413 262 078 |
| UITGEEST_TON SCHOLTEN TEGELS EN SANITAIR · 0031 251 31 91 01 |
| VLAARDINGEN_BAKKER TEGELS & BADKAMERS · 0031 10 434 2058 |
| WASSENAAR_BOUWCENTER RAB WASSENAAR · 0031 70 511 7900 |
| ZEELAND_VAN DEN AKKER · 0413 – 256 200 |

| |
|---|
| PAKISTÁN |
| LAHORE_4 WALLS (PRIVATE) LIMITED · +92 42 111 492 557 |
| PANAMÁ |
| COLON_EURO CER S.A. · (507) 2153660 |
| OBARRIO, CIUDAD DE PANAMÁ_EURO CER S.A. · +507 21 53660 |

| |
|--|
| PARAGUAY |
| ASUNCIÓN_IPALE ALTA GAMA · +595 21 613 544 |
| PERÚ |
| LIMA_CASSINELLI · +51 14 513 712 +51 15 612 757 |
| SAN ISIDRO_PORCELANOSA GRUPO PERÚ · +51 1441 41 06 |
| POLONIA |
| BIALYSTOK_AKCESS · +48 85 6643436 +48 85 6643434 |
| BIELSKO-BIALA - ADARI · 338220449 |
| BYDGOSZCZ_SALON MO (BYDGOSZCZ) · +48 52 348 9343 +48 52 348 9354 |
| CZESTOCHOWA_P.H.U. FUGA · +48 34 368 2944 +48 343682944 |
| GLIWICE_ART CERAMIKA · +48 32 339 8200 +48 32 339 8209 |
| GORZÓW WLKP_SALON MO (STUDIO DEKOR) · +48 95 721 4108 +48 95 721 41 |
| GLIWICE - ADARI · 322322155 |
| GORZOW - STEMAR · 0957 204 555 |
| KALISZ_SALON MO (SPECTROOM) · +48 62 502 10 15 |
| KATOWICE - ADARI · 322589574 |
| KATOWICE_MAX FLIZ · +48 32 720 92 00 +48 32 720 92 00 |
| KRAKOW - MAX FLIZ · 0122 907 12 |
| KIELCE_EXCLUSIVE · +48 41 345 75 49 |
| KOLOBRZEG_SALON MO (KOŁOBRZEG) · +48 94 355 18 88 +48 94 355 18 80 |
| KONIN_SALON MO (KONIN) · +48 63 243 31 14 |
| KRAKÓW_MAX FLIZ · +48 01 229 07060 +48 01 229 07060 |
| LESZNO_SALON MO (LESZNO) · +48 65 529 63 63 |
| LODZ_FUMINO · +48 42 637 37 67 |
| LODZ - GRES · 48 42 636-20-38 / 48 601-355-419 |
| LÓDŹ_CERMAG SP ZOO · +48 77 457 35 09/10 +48 77 474 88 82 |
| LUBLIN_SALONIKA · +48 81 740 99 30 |
| LUBLIN - ANDBUD · 081 469 9617 |
| OPOLE_CERMAG SP ZOO (OPOLE) · +48 42 616 55 44 +48 42 611 61 61 |
| OSTRÓW WLKP_SALON MO (OSTRÓW WLKP) · +48 62 735 81 12 +48 62 737 28 91 |
| POZNAN_SALON MO (POZNAN) · +48 61 835 97 50 54 |

PORCELANOSA Showrooms

INTERNACIONAL | INTERNATIONAL

REPÚBLICA CHECA

BRNO_DESIGN BATH SE · +420 547 216 621
LIBEREC_DORINT GROUP, A.S. · +420 602457510
PRAHA_DESIGN BATH SE · +420 222 984 951
PRAHA_DORINT PHA S.R.O. · +420 271 745 269

REPÚBLICA DEMOCRÁTICA DEL CONGO

KINSHASA_SOCIETE PANACHE · +243 884 1677 +243 983 13893

REUNIÓN

SAINT DENIS_RAVATE PROFESSIONNEL SAS · +262 904 024 +262 904 057

RUMANÍA

BRASOV_DELTA STUDIO BRASOV · 0722 632 013
BUCAREST_GLAMOUR DESIGN PROIECT SRL · (+40) 0747 294 194
CONSTANTA_DELTA STUDIO CONSTANTA · 0722 240 736
IASI_DELTA STUDIO IASI · 730586938
ORADEA_MAISON DESIGN · 0259 410 170
PITESTI_DELTA STUDIO PITESTI · 0723 363 823
PLOIESTI_DELTA STUDIO PLOIESTI · 723541737

SENEGAL

DAKAR_C.C.S. · +221 33 849 04 04 +221 33 823 13 10

SERBIA

BELGRADO_HOME CONCEPT · +381 11 6558 960
BELGRADO_PORCELANOSA HOME CONCEPT · +381 11 6557 087

SINGAPUR

SINGAPUR_FERNANDO MARTIN BENITO · +65 97801472 +65 64621620

SIRIA

DAMASCO_M3MAR TRADING COMPANY · +96 11 3321257

SRI LANKA

COLOMBO 13_RANJANAS CERAMIC · +94 11 2543255 +94 11 2381386

SUDÁFRICA

CAPE TOWN_CLASSIC TRADING · 021 465 9277 021 462 0973
DURBAN_CLASSIC TRADING · +27 31 579 1900 +27 31 577 7056
JOHANNESBURG_CLASSIC TRADING · +27 11 656 0400 +27 11 656 0403

SUECIA

BROMMA_KAKELPALATZET I BROMA AB · +46 (0)8 56 487 831
KATRINEHOLM_KAKELPALATZET I KATRINEHOLM AB · +46 (0)8150-51 740
MÖLNDAL - KAKELPALATZET I MÖLNDAL HEADQUARTERS · +46 (0)31 776 50 51

SUIZA

AUBONNE_ARGECOM SA · +41(0)21 807 10 10 +41(0)21 808 61 02
CRANS-MONTANA_DADA ARCHITECTURE + DESIGN SÄRL · 41274804001
CRISSIER_MAGENTA HOME DESIGN · 0041 848 308 308
LE LIGNON_MAGENTA HOME DESIGN · 0041 848 308 308
LUGANO-GRANCIA_PL VALLI SA · +41 919 859 510
VOLKETSWIL_MPV HANDELS AG · +41 (0)43 399 53 00 +41 (0)43 399 53 20

SURINAM

PARAMARIBO_JAP HOUSING · +597 817-0064

TAILANDIA

BANGKOK_BOONTHAVORN CERAMIC (RATCHADAPISEK) · +66 2275-0029 +66 2275-2057
BANGKOK_BOONTHAVORN CERAMIC CO. LTD. (PIN-KLAO) · +66 2441-3075 +66 2441-4049
BANGKOK_BOONTHAVORN CERAMIC CO. LTD. (KASET NAVAMIN) · +66 2791-2777 +66 2943-9058
BANGKOK_BOONTHAVORN CERAMIC CO. LTD. (SUVARNNABHUMI) · +66 2316-0429 +66 2750 0682
BANGKOK_BOONTHAVORN CERAMIC CO. LTD. (PATTAYA) · +66 38 052 222 +66 38 052 221
CHIANGMAI_BOONTHAVORN CERAMIC CO. LTD. (CHIANGMAI) · +66 5310-5099 +66 5310-5107
MUEANG SURAT THANI DISTRICT_BOONTHAVORN CERAMIC - SURAT THANI · +66 77 237 000
PATHUMTHANEE_BOONTHAVORN CERAMIC CO. LTD. (RANGSIT) · +66 2902-0171 +66 2902-0184
PRACHUABKIRIKUN_BOONTHAVORN CERAMIC CO. LTD. (HUAHIN) · +66 3252 2555
SAMUTSAKHON_BOONTHAVORN CERAMIC - SAMUTSAKHON · +66 2 896 44712
UDON THANI_BOONTHAVORN CERAMIC - UDON THANI · +66 42 215 678

TAIWAN

TAICHUNG CITY 408_MAOJUN ENTERPRISE CO LTD · 00 886 4 2250 6688
TAIPEI CITY_PORCELANOSA ASSOCIATE TAIPEI · (02) 27923788

TANZANIA

DAR ES SALAAM_ABC EMPORIO TANZANIA · +255 719885566

TOGO

LOMÉ_STÉ. LE WATT · 00228 90 57 72 72

TRINIDAD Y TOBAGO

CHAGUANAS, TRINIDAD_TILE EXPRESSION · 18682902727

TÚNEZ

GABES_ABC ABDENNADHER · 75 29 49 10 74 24 48 85
HAMMAM SOUSSE_ABC ABDENNADHER · 73 32 44 24 73 32 44 25
HAMMAMET_ABC ABDENNADHER · 72 26 04 77 72 26 04 77
MENZEL HAYET_ABC ABDENNADHER · 73 41 04 16 73 41 04 01
SFAX_ABC ABDENNADHER · 74 46 80 72 74 24 48 85
SOUSSE_ABC ABDENNADHER · 73 37 14 76 73 37 14 75
TUNIS_ABC ABDENNADHER · 71 72 58 80 71 72 57 77 71 76 00 46
TUNIS_LIFE STYLE · +216 71 861 551 +216 71 861 549
TUNIS CEDEX_ABDENNADHER BRICOLAGE CENTER · +216 71 725 194 +216 71 760 046

TURQUÍA

ISTAMBUL_YÜTAS · +90 2 1227 44720 +90 2 1227 20874
BURSA_HSF PROJE TASARIMDEK YAPI MALZ INS SAN VE TIC LTD STI · 90 224 451 02 24
ISTANBUL_AKSESUAR DESIGN - ISTAMBUL · 902125985599

UCRANIA

DNIPRO_AGROMAT DNIPRO · 800 30 30 19
DNIPROPETROVSK_EUROPA DNIPRO (0562) 31-27-53
IVANO FRANKIVSK · 0038 0681526521
KHARKIV_AGROMAT BANNYY · (067)559-85-27
KHARKIV_AGROMAT KHARKIV · (067)559-84-91
KHARKIV_NANO CERAMICA · 380660544293
KHERSON_SALON VORONTSOVSKYI · 380 05 52 44 44 44
KHMELNYTSKYI_AQUAROOM · 380687712071
KHMELNYTSKYI_AGROMAT KHMELNYTSKYI · 676083563
KYIV_AGROMAT BULAHOVSKOHO · 380800303019
KYIV_SALON MILLENNIUM CONCEPT · (044) 279 60 60
LVIV_AGROMAT LVIV · 977521428
LVIV_KERAMA MARKET · 380 322 972 500
MYKOLAIV_YALOT · 38(0512) 500-284
ODESA_AGROMAT ODESA · 067-443-51-69
POLTAVA_DOGODA · 38(0532)68-75-75
TERNOPIL_VERO · 098 67 67 112
VINNYTSIA_AGROMAT VINNYTSIA · 432575001
VINNYTSIA_LANA · 380432507838

UGANDA

KAMPALA_ABC STILES & BATHZ · +256 776022333

URUGUAY

MONTEVIDEO_ACHER · +598 2 487 5630
MONTEVIDEO_BOSCH & CIA MONTEVIDEO · 00598- 27084545

UZBEKISTÁN

TASHKENT_PREMIUM CONCEPT · +998 71 256 29 05
TASHKENT_PORCELANOSA TASHKENT · +998 97 753 00 65

VENEZUELA

CARACAS_PORCELANOSA CARACAS · 58 424 131-9949

VIETNAM

HANOI_MILAN ARCHITECTURAL · 0913212568 0986110133
HANOI_MILAN ARCHITECTURAL · +84 8 5412 1819 +84 8 5412 1820
HANOI_MILAN HOME CENTER · 977800785 +84 4 3234 5028
HANOI_MILAN HOME CENTER DISTRIBUIDOR MR VU THAI · +84 9 1321 2568 +84 4 3234 5028
HO CHI MINH CITY_CASABELLA CO LTD · +84 9 1323 7771

YIBUTI

DJIBOUTI_AL-NEIMA IMMOBILIERE · 00253-21356659 00253-21356289



butech

PORCELANOSA Grupo

1ª Ed. | 01/2022

Design and photography: butech Marketing Department

Edited by: butech building technology, S.A.U.

Print: EGEDSA

butech building technology, S.A.U.

Ctra. Villarreal - Puebla de Arenoso
(CV-20) Km 2,5. Villarreal (Spain)

+34 964 53 62 00

butech@butech.es



www.butech.net

The contents of this catalog are protected by Intellectual Property Law, Royal Decree 1 / 1996. Any reproduction of it, in whole or in part, without the consent of PORCELANOSA Grupo is liable under the Penal Code.

