

BATHROOM SERIES

MAMPARAS DE DUCHA

SHOWER SCREENS

PAROI DE DOUCHE

SP

PORCELANOSA

SP
PORCELANOSA



BY APPOINTMENT TO
H.R.H. THE PRINCE OF WALES
MANUFACTURER AND DISTRIBUTOR
OF CERAMIC TILES AND BUILDING PRODUCTS.
PORCELANOSA GROUP LIMITED

PORCELANOSA Grupo

ÍNDICE

INDEX · INDICE

ATTICA	6-21
VITRA	22-31
SILKE	32-39
S+LINE	40-51
NEO	52-71
DECA	72-79
YOVE	80-89
INTER	90-99
OPTIMA	100-107
JAVA	108-113

Accesorios · Accessories · Accessoires

PLANE	114-115
-------	---------

Información · Information · Information

SystemGlass	116
Serigrafía · Glass finish · Sérigraphie	117
Acabados · Finish · Finitions	118-119





MAMPARAS ENCLOSURES PAROIS

Unas mamparas que cubren todos los estilos de vida para que la familia pueda disfrutar a diario de la ducha.
Convertir el baño en un espacio más agradable y funcional es propio de
KRION SOLID SURFACE y de sus mamparas.

Products to suit all lifestyles. Transforming the bathroom into a more pleasant and functional space is the com-
mitment of KRION SOLID SURFACE.

Des parois qui regroupent tous les styles de vie pour que la famille puisse quotidiennement profiter de la douche
au maximum. Changer la salle de bain en un espace plus agréable et plus fonctionnel est propre a
KRION SOLID SURFACE et a ses parois de douches.

ATTICA

El diseño enfocado a la facilidad de uso está implícito en todos sus detalles. Bisagras y anclajes alineados con los cristales para su fácil limpieza, ergonomía interior del tirador, innovador sistema pivotante de sus bisagras para obtener una suave apertura y cierre a la vez que una óptima estanqueidad. Attica, fabricada en cristal templado de 8mm con el exclusivo tratamiento fácil limpieza Systemglass y sus complementos con acabados cromados alto brillo, es la combinación perfecta de elegancia de formas y minimalismo.

A design focusing on ease of use is implicit in all of its details. Hinges and fastenings aligned with the glass to make it easy to clean, the interior ergonomics of the handle, the innovative pivoting system used for the hinges to ensure gentle opening and closing, as well as a perfectly watertight seal. Attica, made of tempered 8 mm glass with the exclusive easy-to-clean Systemglass treatment and its accessories in a high-gloss chrome finish, is the perfect combination of elegant shapes and minimalism.

L'alliance de la délicatesse et de la fonctionnalité donne naissance à une paroi de douche simple et sophistiquée, avec une nouvelle finition noire mate qui met en valeur ses formes à la fois simples et délicates, en lui conférant élégance et distinction.

La fusion de la pureté de son concept avec l'harmonie des formes rectangulaires adoucies de ses éléments font de cette paroi de douche une proposition innovante qui sait répondre aux attentes les plus exigeantes.

CRISTALES · GLASS · VERRES



transparente
clear
transparent



black
mirror

SystemGlass

Tratamiento fácil limpieza.
Easy clean treatment.
Traitement facile à nettoyer.

SERIGRAFÍAS · GLASS DESIGNS · SÉRIGRAPHIE



FILO



DECO



OPAL



LINE



SERIGRAFÍAS PERSONALIZABLES
CUSTOMIZABLE SCREEN PRINTINGS
SÉRIGRAPHIES PERSONNALISÉS

HERRAJES · FITTINGS · FERRURES

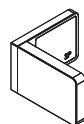

soporte a pared
Wall bracket
support mural

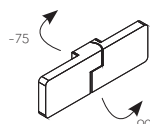

bisagra cristal-cristal
Glass-glass hinge
charnière vitrage - vitrage

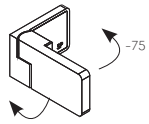

bisagra cristal-pared
Glass-wall hinge
charnière vitrage - mur



cromo
chrome
chromé



negro mate
matt black
noir mat

TENSORES · TENSORS · TENDEURS

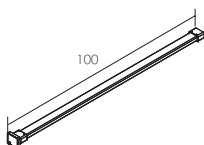

cromo
chrome
chromé



negro mate
matt black
noir mat







ATTICA 1



ATTICA 9



ATTICA 2C + 5



ATTICA 4





ATTICA 10



ATTICA P



ATTICA P10



ATTICA 9/9



ATTICA 2B



ATTICA 9/9B

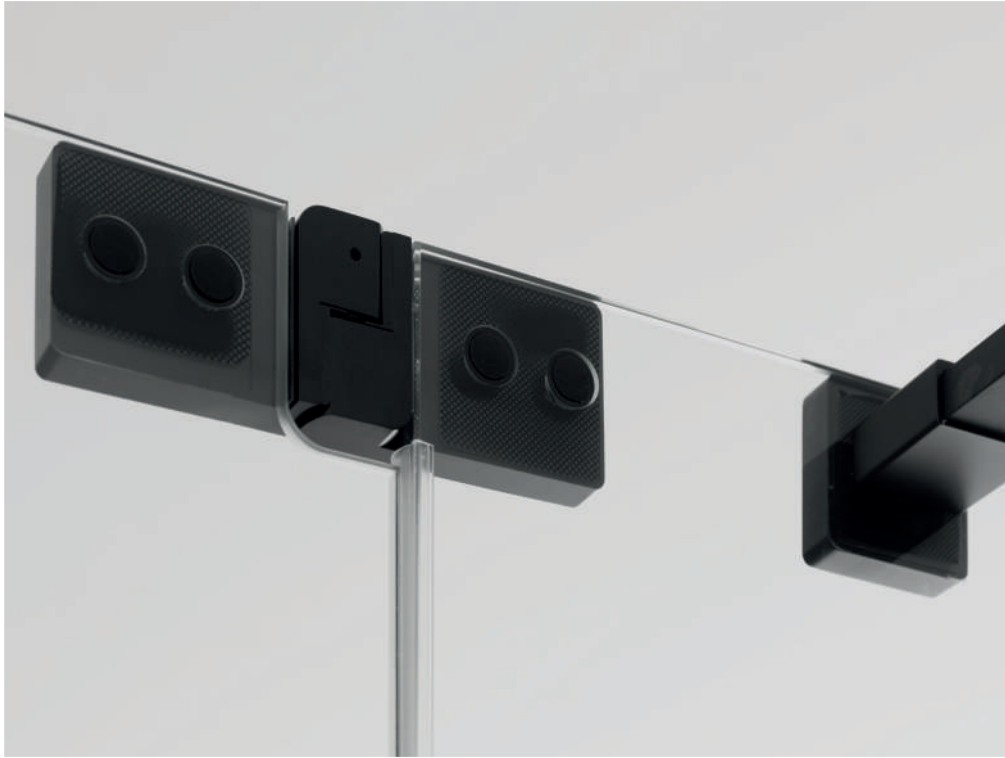



ATTICA 9 BLACK





ATTICA 9C + 5 BLACK



ATTICA P BLACK

ATTICA SERIES

ATTICA 1

2.000 h

DERECHA · RIGHT · DROITE IZQUIERDA · LEFT · GAUCHE

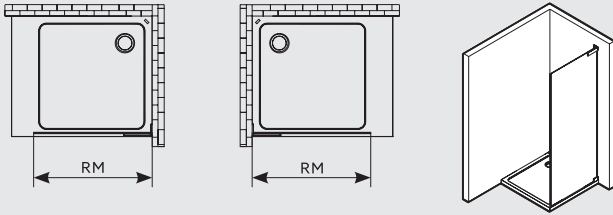

MODELO MODEL MODÈLE	MEDIDA REAL (RM) REAL MEASUREMENTS (RM) TAILLE RÉEL (RM)
cm	mm
ATTICA 1 70	685-705
ATTICA 1 80	785-805
ATTICA 1 90	885-905
ATTICA 1 100	985-1005
ATTICA 1 110	1085-1105
ATTICA 1 120	1185-1205
ATTICA 1 130	1285-1305
ATTICA 1 140	1385-1405
ATTICA 1 150	1485-1505

ATTICA 2

2.000 h

DERECHA · RIGHT · DROITE IZQUIERDA · LEFT · GAUCHE

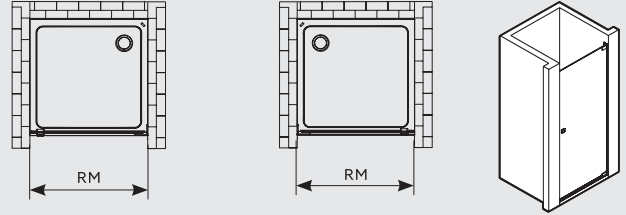

MODELO MODEL MODÈLE	MEDIDA REAL (RM) REAL MEASUREMENTS (RM) TAILLE RÉEL (RM)	APERTURA OPENING OUVERTURE
cm	mm	mm
ATTICA 2 80	785-800	750
ATTICA 2 90	885-900	850

ATTICA 2C

DERECHA · RIGHT · DROITE IZQUIERDA · LEFT · GAUCHE

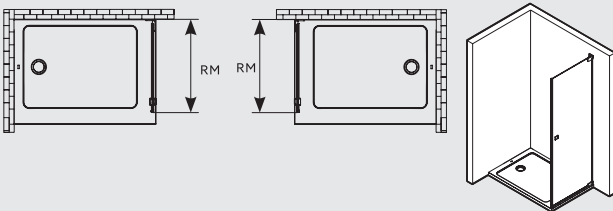

MODELO MODEL MODÈLE	MEDIDA REAL (RM) REAL MEASUREMENTS (RM) TAILLE RÉEL (RM)	APERTURA OPENING OUVERTURE
cm	mm	mm
ATTICA 2C 70	679	650
ATTICA 2C 75	729	700
ATTICA 2C 80	779	750
ATTICA 2C 90	879	850

* Instalar junto con ATTICA 5 · Install with ATTICA 5 · Installer avec ATTICA 5.

ATTICA 4

DERECHA · RIGHT · DROITE IZQUIERDA · LEFT · GAUCHE

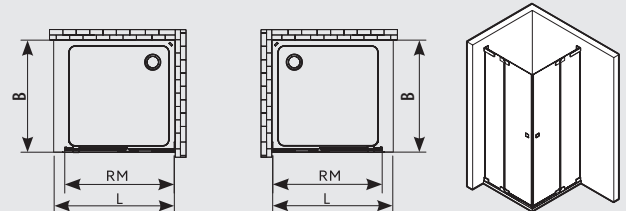

MODELO MODEL MODÈLE	MEDIDA PLATO (L) SIZE OF TRAY (L) MESURES RECEVEUR (L)	MEDIDA REAL (RM) REAL MEASUREMENTS (RM) TAILLE RÉEL (RM)
cm	mm	mm
ATTICA 4 70	685-700	674-689
ATTICA 4 75	735-750	724-739
ATTICA 4 80	785-800	774-789
ATTICA 4 90	885-900	874-889
ATTICA 4 100	985-1000	974-989
ATTICA 4 110	1085-1100	1074-1089
ATTICA 4 120	1185-1200	1174-1189

* Se debe pedir 1 mampara de mano izquierda y otra de mano derecha.

* It is required to order 1 right hand-side unit and 1 left hand-side unit.

* On l'exige pour commander 1 unité de côté droit et 1 unité de côté de main gauche.

ATTICA 9

2.000 h

DERECHA · RIGHT · DROITE

IZQUIERDA · LEFT · GAUCHE

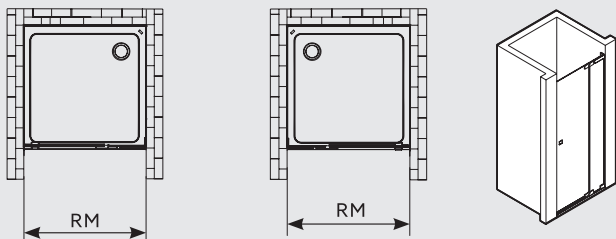

MODELO MODEL MODÈLE	MEDIDA REAL (RM) REAL MEASUREMENTS (RM) TAILLE RÉEL (RM)	APERTURA OPENING OUVERTURE
cm	mm	mm
ATTICA 9 80	775-805	560
ATTICA 9 90	875-905	560
ATTICA 9 100	975-1005	560
ATTICA 9 110	1075-1105	560
ATTICA 9 120	1175-1205	560
ATTICA 9 130	1275-1305	560
ATTICA 9 140	1375-1405	560
ATTICA 9 150	1475-1505	560

ATTICA 9C

2.000 h

DERECHA · RIGHT · DROITE

IZQUIERDA · LEFT · GAUCHE

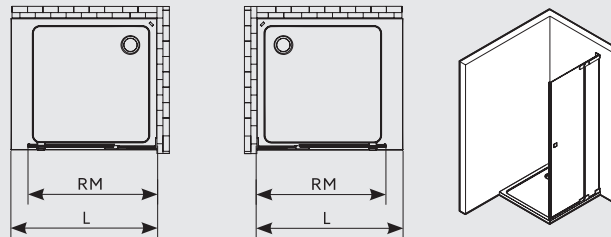

MODELO MODEL MODÈLE	MEDIDA PLATO (L) SIZE OF TRAY (L) MESURES RECEVEUR (L)	MEDIDA REAL (RM) REAL MEASUREMENTS (RM) TAILLE RÉEL (RM)	APERTURA OPENING OUVERTURE
cm	mm	mm	mm
ATTICA 9C 80	785-800	774-789	560
ATTICA 9C 90	885-900	874-889	560
ATTICA 9C 100	985-1000	974-989	560
ATTICA 9C 110	1085-1100	1074-1089	560
ATTICA 9C 120	1185-1200	1174-1189	560
ATTICA 9C 130	1285-1300	1274-1289	560
ATTICA 9C 140	1385-1400	1374-1389	560
ATTICA 9C 150	1485-1500	1474-1489	560

* Instalar junto con ATTICA 5 · Install with ATTICA 5 · Installer avec ATTICA 5.

ATTICA 9+

DERECHA · RIGHT · DROITE

IZQUIERDA · LEFT · GAUCHE

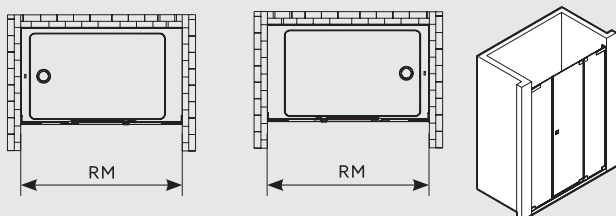

MODELO MODEL MODÈLE	MEDIDA REAL (RM) REAL MEASUREMENTS (RM) TAILLE RÉEL (RM)	APERTURA OPENING OUVERTURE
cm	mm	mm
ATTICA 9+ 120	1175-1205	555
ATTICA 9+ 130	1275-1305	555
ATTICA 9+ 140	1375-1405	555
ATTICA 9+ 150	1475-1505	555
ATTICA 9+ 160	1575-1605	555
ATTICA 9+ 170	1675-1705	555
ATTICA 9+ 180	1775-1805	555

ATTICA 9/9

SIN MANO · NO HAND · SANS SENS



MODELO MODEL MODÈLE	MEDIDA REAL (RM) REAL MEASUREMENTS (RM) TAILLE RÉEL (RM)	APERTURA OPENING OUVERTURE
cm	mm	mm
ATTICA 9/9 150	1475-1505	900
ATTICA 9/9 160	1575-1605	900
ATTICA 9/9 170	1675-1705	900
ATTICA 9/9 180	1775-1805	900
ATTICA 9/9 190	1875-1905	900

ATTICA SERIES

ATTICA 10

2.000 h

DERECHA · RIGHT · DROITE

IZQUIERDA · LEFT · GAUCHE

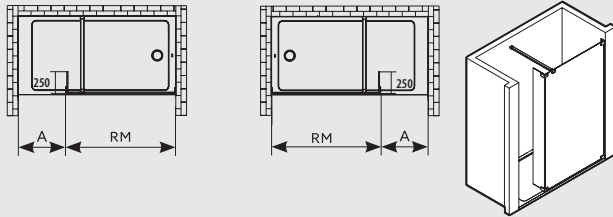

MODELO MODEL MODÈLE	MEDIDA REAL (RM) REAL MEASUREMENTS (RM) TAILLE RÉEL (RM)	APERTURA OPENING OUVERTURE
cm	mm	mm
ATTICA 10 140	785-800	600
ATTICA 10 150	885-900	600
ATTICA 10 160	985-1000	600
ATTICA 10 170	1085-1100	600
ATTICA 10 180	1185-1200	600

ATTICA P

2.000 h

SIN MANO · NO HAND · SANS SENS

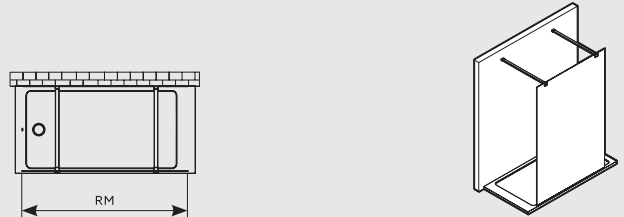

MODELO MODEL MODÈLE	MEDIDA REAL (RM) REAL MEASUREMENTS (RM) TAILLE RÉEL (RM)
cm	mm
ATTICA P 120	1180
ATTICA P 140	1380

ATTICA P10

2.000 h

SIN MANO · NO HAND · SANS SENS

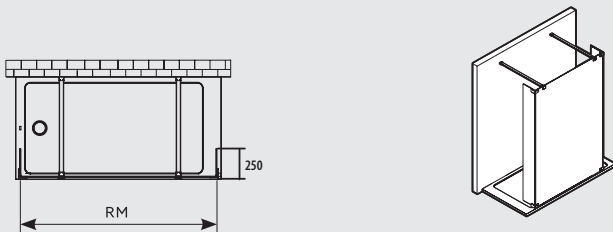

MODELO MODEL MODÈLE	MEDIDA REAL (RM) REAL MEASUREMENTS (RM) TAILLE RÉEL (RM)
cm	mm
ATTICA P10 120	1175
ATTICA P10 140	1375

ATTICA 5

2.000 h

DERECHA · RIGHT · DROITE

IZQUIERDA · LEFT · GAUCHE

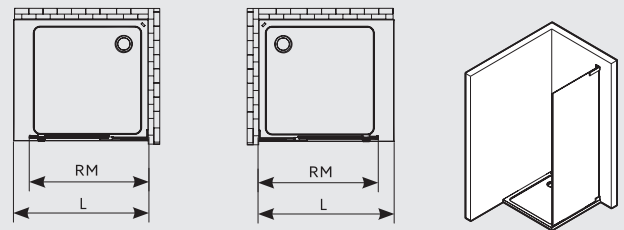

MODELO MODEL MODÈLE	MEDIDA PLATO (L) SIZE OF TRAY (L) MESURES RECEVEUR (L)	MEDIDA REAL (RM) REAL MEASUREMENTS (RM) TAILLE RÉEL (RM)
cm	mm	mm
ATTICA 5 70	685-705	673-693
ATTICA 5 75	735-755	723-743
ATTICA 5 80	785-805	773-793
ATTICA 5 90	885-905	873-893
ATTICA 5 100	985-1005	973-993
ATTICA 5 110	1085-1105	1073-1093
ATTICA 5 120	1185-1205	1173-1193
ATTICA 5 130	1285-1305	1273-1293
ATTICA 5 140	1385-1405	1373-1393
ATTICA 5 150	1485-1505	1473-1493

* Instalar junto con ATTICA 2C/9C · Install with ATTICA 2C/9C ·
Installer avec ATTICA 2C/9C.

ATTICA 2B

1.500 h

DERECHA · RIGHT · DROITE

IZQUIERDA · LEFT · GAUCHE

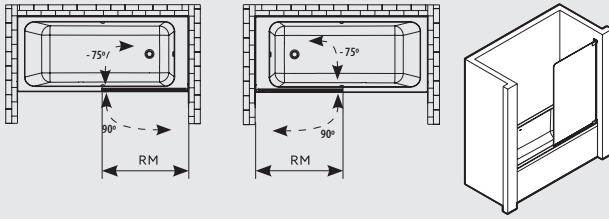

MODELO MODEL MODÈLE	MEDIDA REAL (RM) REAL MEASUREMENTS (RM) TAILLE RÉEL (RM)	APERTURA OPENING OUVERTURE
cm	mm	mm
ATTICA 2B 80	800	780
ATTICA 2B 90	900	880

ATTICA 2B+

1.500 h

DERECHA · RIGHT · DROITE

IZQUIERDA · LEFT · GAUCHE

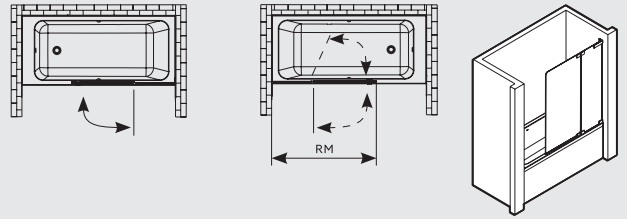

MODELO MODEL MODÈLE	MEDIDA REAL (RM) REAL MEASUREMENTS (RM) TAILLE RÉEL (RM)	APERTURA OPENING OUVERTURE
cm	mm	mm
ATTICA 2B+ 100	985-1000	780
ATTICA 2B+110	1085-1100	780
ATTICA 2B+120	1185-1200	780

ATTICA 9/9B

1.500 h

SIN MANO · NO HAND · SANS SENS

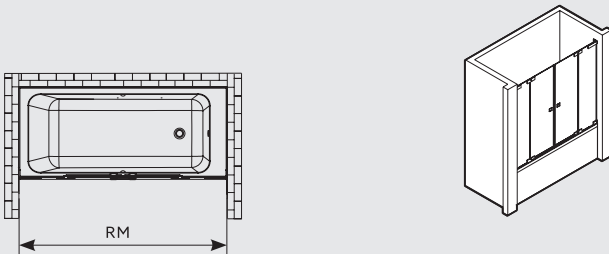

MODELO MODEL MODÈLE	MEDIDA REAL (RM) REAL MEASUREMENTS (RM) TAILLE RÉEL (RM)	APERTURA OPENING OUVERTURE
cm	mm	mm
ATTICA 9/9B 150	1475-1505	900
ATTICA 9/9B 160	1575-1605	900
ATTICA 9/9B 170	1675-1705	900
ATTICA 9/9B 180	1775-1805	900
ATTICA 9/9B 190	1875-1905	900

VITRA

La serie de mamparas VITRA presenta formas curvas y sólidas con un diseño revolucionario. Por sus características formales permite multitud de instalaciones, incluyendo adaptaciones con puertas correderas curvas o modelos para instalar sobre bañera.

La arquitectura que emplea (con acero inoxidable y vidrio) hace de la serie VITRA un referente de diseño que permanece en el tiempo, garantizando el concepto de bienestar en el espacio del baño.

VITRA is an enclosure series easily recognizable for its solid, curved shapes and revolutionary design. Thanks to its formal characteristics, it can be fitted in numerous different ways, even with curved sliding doors. Likewise, VITRA also features models that can be fitted on bathtubs.

Made of stainless steel and glass, VITRA's design gives it a timeless appeal, guaranteeing the concept of wellbeing in bathrooms.

La série de parois VITRA se distingue par des formes courbes et solides dont le design est révolutionnaire. Leurs caractéristiques formelles permettent une infinité d'applications, y compris des adaptations pour des portes coulissantes courbes ou des modèles à installer sur la baignoire.

L'architecture qui emploie ces produits (en acier inoxydable et en verre) fait de la série VITRA une référence de design qui résiste au temps pour garantir le concept de bien-être dans l'espace de la salle de bains.

CRISTALES · GLASS · VERRES



SystemGlass

Tratamiento fácil limpieza.
Easy clean treatment.
Traitement facile à nettoyer.

SERIGRAFÍAS · GLASS DESIGNS · SÉRIGRAPHIE



FLO



DECO



OPAL



LINE



SERIGRAFÍAS PERSONALIZABLES
CUSTOMIZABLE SCREEN PRINTINGS
SÉRIGRAPHIES PERSONNALISÉS

PERFILES · PROFILES · PROFILS



aluminio acabado inox
aluminium inox
aluminium finition inox

HERRAJES · FITTINGS · FERRURES



inox

GUÍA SUPERIOR · TOP GUIDE · GUIDE SUPÉRIEUR

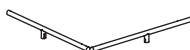

inox









VITRA 6



VITRA 9/9



VITRA 9C + 5





VITRA SERIES

VITRA 4

2.070 h

DERECHA · RIGHT · DROITE IZQUIERDA · LEFT · GAUCHE

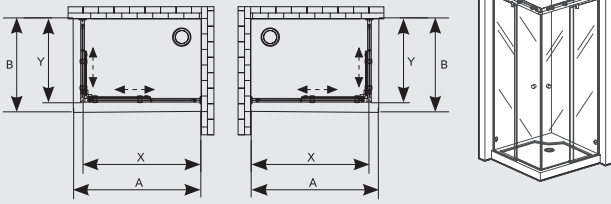

MODELO MODEL MODÈLE	MEDIDA PLATO (AxB) SIZE OF TRAY (AxB) MESURES RECEVEUR (AxB)	MEDIDA REAL (XxY) REAL MEASUREMENTS (XxY) TAILLE RÉEL (XxY)	APERTURA OPENING OUVERTURE
cm	mm	mm	mm
VITRA 4 80 x 80	780-800 x 780-800	755-775 x 755-775	412
VITRA 4 90 x 90	880-900 x 880-900	855-875 x 855-875	483
VITRA 4 100 x 100	980-1000 x 980-1000	955-975 x 955-975	554
VITRA 4 90 x 75	880-900 x 730-750	855-875 x 705-725	434
VITRA 4 100 x 70	980-1000 x 680-700	955-975 x 655-675	460
VITRA 4 110 x 80	1080-1100 x 780-800	1055-1075 x 755-775	529
VITRA 4 120 x 70	1180-1200 x 680-700	1155-1175 x 655-675	549
VITRA 4 120 x 75	1180-1200 x 730-750	1155-1175 x 705-725	559
VITRA 4 100 x 75	980-1000 x 730-750	955-975 x 705-725	474
VITRA 4 100 x 80	980-1000 x 780-800	955-975 x 755-775	488
VITRA 4 100 x 90	980-1000 x 880-900	955-975 x 855-875	519
VITRA 4 120 x 90	1180-1200 x 880-900	1155-1175 x 855-875	599

VITRA 6

2.070 h

SIN MANO · NO HAND · SANS SENS

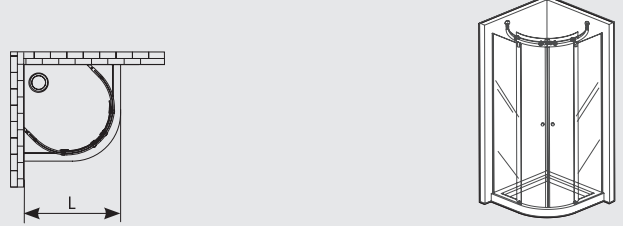

MODELO MODEL MODÈLE	MEDIDA PLATO (L) SIZE OF TRAY (L) MESURES RECEVEUR (L)	APERTURA OPENING OUVERTURE
cm	mm	mm
VITRA 6 80	780-810	440
VITRA 6 90	880-910	500

VITRA 9

2.070 h

DERECHA · RIGHT · DROITE IZQUIERDA · LEFT · GAUCHE

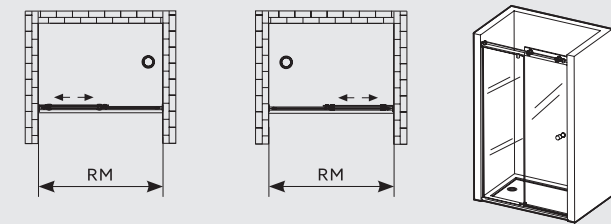

MODELO MODEL MODÈLE	MEDIDA REAL (RM) REAL MEASUREMENTS (RM) TAILLE RÉEL (RM)	APERTURA OPENING OUVERTURE
cm	mm	mm
VITRA 9 120	1170-1210	510
VITRA 9 130	1270-1310	560
VITRA 9 140	1370-1410	560
VITRA 9 150	1470-1510	660
VITRA 9 160	1570-1610	660
VITRA 9 170	1670-1710	660

VITRA 9C

2.070 h

DERECHA · RIGHT · DROITE IZQUIERDA · LEFT · GAUCHE

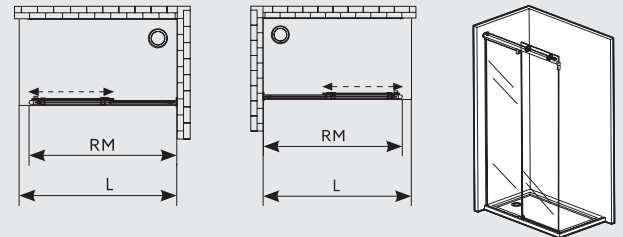

MODELO MODEL MODÈLE	MEDIDA PLATO (L) SIZE OF TRAY (L) MESURES RECEVEUR (L)	MEDIDA REAL (RM) REAL MEASUREMENTS (RM) TAILLE RÉEL (RM)	APERTURA OPENING OUVERTURE
cm	mm	mm	mm
VITRA 9C 120	1180-1200	1165-1185	490
VITRA 9C 140	1380-1400	1365-1385	540
VITRA 9C 150	1480-1500	1465-1485	640
VITRA 9C 160	1580-1600	1565-1585	640
VITRA 9C 170	1680-1700	1665-1685	640

* Instalar junto con VITRA 5 · Install with VITRA 5 · Installer avec VITRA 5.

VITRA 9/9

2.070 h

SIN MANO · NO HAND · SANS SENS

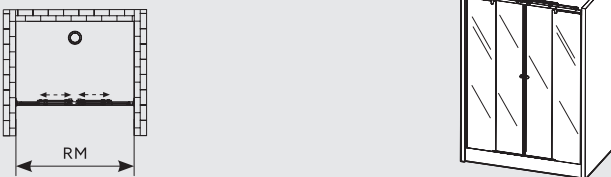

MODELO MODEL MODÈLE	MEDIDA REAL (RM) REAL MEASUREMENTS (RM) TAILLE RÉEL (RM)	APERTURA OPENING OUVERTURE
cm	mm	mm
VITRA 9/9 150	1470-1510	550
VITRA 9/9 160	1570-1610	550
VITRA 9/9 170	1670-1710	550

VITRA 5

1.980 h

DERECHA · RIGHT · DROITE

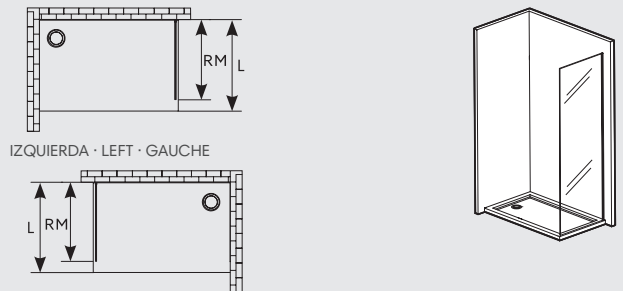

MODELO MODEL MODÈLE	MEDIDA PLATO (L) SIZE OF TRAY (L) MESURES RECEVEUR (L)	MEDIDA REAL (RM) REAL MEASUREMENTS (RM) TAILLE RÉEL (RM)
cm	mm	mm
VITRA 5 70	680-700	665-675
VITRA 5 75	730-750	715-725
VITRA 5 80	780-800	765-775
VITRA 5 90	880-900	865-875

* Instalar junto con VITRA 9C · Install with VITRA 9C · Installer avec VITRA 9C.

VITRA 9B

1.520 h

DERECHA · RIGHT · DROITE

IZQUIERDA · LEFT · GAUCHE

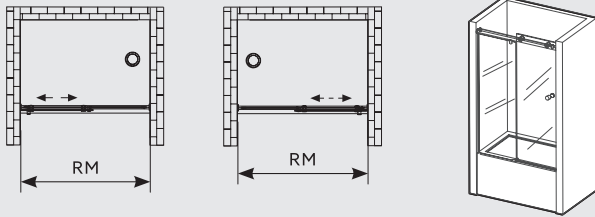

MODELO MODEL MODÈLE	MEDIDA REAL (RM) REAL MEASUREMENTS (RM) TAILLE RÉEL (RM)	APERTURA OPENING OUVERTURE
cm	mm	mm
VITRA 9B 150	1470-1510	680
VITRA 9B 160	1570-1610	730
VITRA 9B 170	1670-1710	770
VITRA 9B 180	1770-1810	770

VITRA 9B C

1.520 h

DERECHA · RIGHT · DROITE

IZQUIERDA · LEFT · GAUCHE

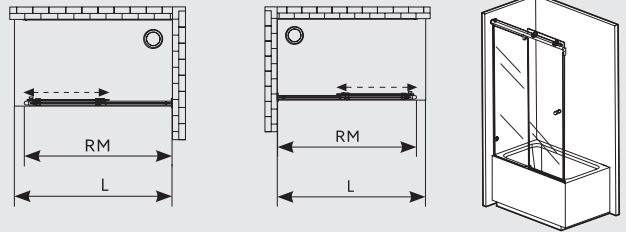

MODELO MODEL MODÈLE	MEDIDA PLATO (L) SIZE OF TRAY (L) MESURES RECEVEUR (L)	MEDIDA REAL (RM) REAL MEASUREMENTS (RM) TAILLE RÉEL (RM)	APERTURA OPENING OUVERTURE
cm	mm	mm	mm
VITRA 9B C 160	1580-1600	1565-1585	680
VITRA 9B C 170	1680-1700	1665-1685	730
VITRA 9B C 180	1780-1800	1765-1785	730

* Instalar junto con VITRA 5B · Install with VITRA 5B · Installer avec VITRA 5B.

VITRA 9/9B

1520 h

SIN MANO · NO HAND · SANS SENS

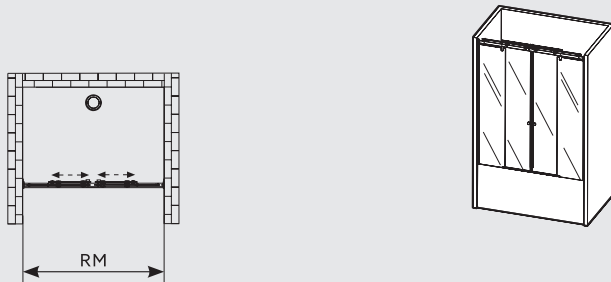

MODELO MODEL MODÈLE	MEDIDA REAL (RM) REAL MEASUREMENTS (RM) TAILLE RÉEL (RM)	APERTURA OPENING OUVERTURE
cm	mm	mm
VITRA 9/9B 160	1570-1610	550
VITRA 9/9B 170	1670-1710	550
VITRA 9/9B 180	1770-1810	550

VITRA 5B

1430 h

DERECHA · RIGHT · DROITE

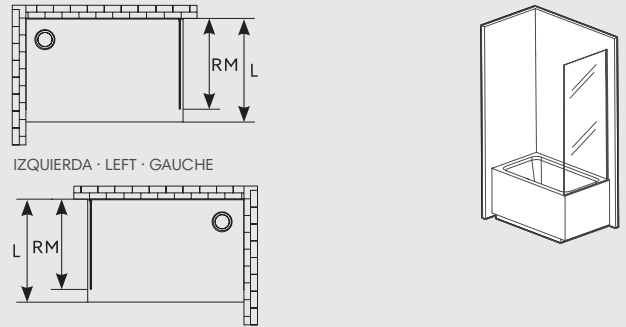

MODELO MODEL MODÈLE	MEDIDA PLATO (L) SIZE OF TRAY (L) MESURES RECEVEUR (L)	MEDIDA REAL (RM) REAL MEASUREMENTS (RM) TAILLE RÉEL (RM)
cm	mm	mm
VITRA 5B 70	680-700	665-675
VITRA 5B 75	730-750	715-725
VITRA 5B 80	780-800	765-775
VITRA 5B 90	880-900	865-875

* Instalar junto con VITRA 9B C · Install with VITRA 9B C · Installer avec VITRA 9B C.

SILKE

La línea de mamparas SILKE se concibe de la extrapolación de formas puras, minimalistas y asépticas, con una intervención amable en su geometría, aúna diseño y tecnología, empleando materiales como aluminio y vidrio, que se integran para generar un espacio diáfano y liviano que invita a acceder a su interior.

The SILKE range of enclosures is based on pure, minimalist and aseptic concepts that have shaped its geometry, in a combination of design and technology, and featuring materials such as aluminium and glass that blend to create a pleasant and light-filled space that draws you in.

La gamme de parois de douche SILKE est le fruit de l'extrapolation de formes pures, minimalistes et aseptiques et d'une intervention discrète sur leur géométrie. Elle allie design à la technologie et est faite de matériaux tels que l'aluminium et le verre, qui s'intègrent pour créer un espace diaphane et lumineux qui invite à y pénétrer.

CRISTALES · GLASS · VERRES



SystemGlass

Tratamiento fácil limpieza.
Easy clean treatment.
Traitement facile à nettoyer.

SERIGRAFÍAS · GLASS DESIGNS · SÉRIGRAPHIE



FLO



DECO



OPAL



LINE



SERIGRAFÍAS PERSONALIZABLES
CUSTOMIZABLE SCREEN PRINTINGS
SÉRIGRAPHIES PERSONNALISÉS

HERRAJES · FITTINGS · FERRURES



cromo
chrome
chromé

GUÍA SUPERIOR · TOP GUIDE · GUIDE SUPÉRIEUR



cromo
chrome
chromé

PERFILES · PROFILES · PROFILS



anodizado alto brillo
high gloss anodized
anodysé haut brillant



transparente
transparent
прозрачный









SILKE 9C + 5





SILKE 9B



SILKE 9B C + 5B



SILKE 9/9B

SILKE SERIES

SILKE 4

2.040 h

DERECHA · RIGHT · DROITE IZQUIERDA · LEFT · GAUCHE

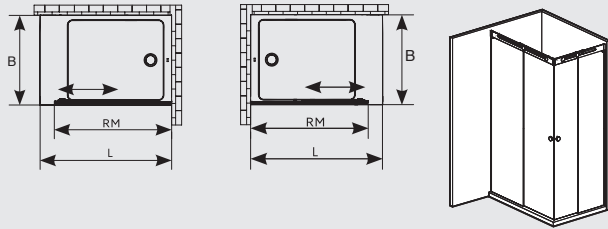

MODELO MODEL MODÈLE	MEDIDA PLATO (L) SIZE OF TRAY (L) MESURES RECEVEUR (L)	MEDIDA REAL (RM) REAL MEASUREMENTS (RM) TAILLE RÉEL (RM)
cm	mm	mm
SILKE 4 70	680-700	668-688
SILKE 4 75	730-750	718-738
SILKE 4 80	780-800	768-788
SILKE 4 90	880-900	868-888
SILKE 4 100	980-1000	968-988
SILKE 4 110	1080-1100	1068-1088
SILKE 4 120	1180-1200	1168-1188

SILKE 9

2.040 h

DERECHA · RIGHT · DROITE IZQUIERDA · LEFT · GAUCHE

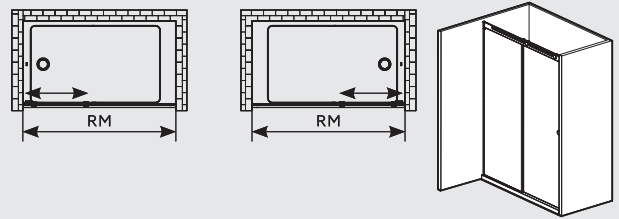

MODELO MODEL MODÈLE	MEDIDA REAL (RM) REAL MEASUREMENTS (RM) TAILLE RÉEL (RM)	APERTURA OPENING OUVERTURE
cm	mm	mm
SILKE 9 120	1170-1210	480
SILKE 9 130	1270-1310	540
SILKE 9 140	1370-1410	540
SILKE 9 150	1470-1510	630
SILKE 9 160	1570-1610	630
SILKE 9 170	1670-1710	630
SILKE 9 180	1770-1810	630

SILKE 9C

2.040 h

DERECHA · RIGHT · DROITE IZQUIERDA · LEFT · GAUCHE

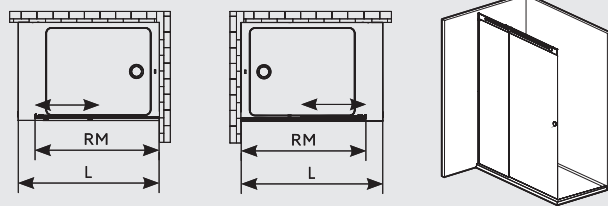

MODELO MODEL MODÈLE	MEDIDA PLATO (L) SIZE OF TRAY (L) MESURES RECEVEUR (L)	MEDIDA REAL (RM) REAL MEASUREMENTS (RM) TAILLE RÉEL (RM)	APERTURA OPENING OUVERTURE
cm	mm	mm	mm
SILKE 9C 120	1180-1200	1168-1188	470
SILKE 9C 130	1280-1300	1268-1288	530
SILKE 9C 140	1380-1400	1368-1388	530
SILKE 9C 150	1480-1500	1468-1488	620
SILKE 9C 160	1580-1600	1568-1588	620
SILKE 9C 170	1680-1700	1668-1688	620
SILKE 9C 180	1780-1800	1768-1788	620

* Instalar junto con SILKE 5 · Install with SILKE 5 · Installer avec SILKE 5.

SILKE 9/9

2.040 h

SIN MANO · NO HAND · SANS SENS

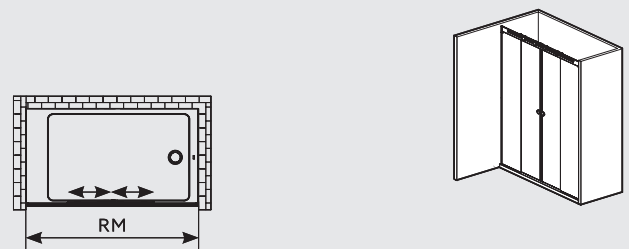

MODELO MODEL MODÈLE	MEDIDA REAL (RM) REAL MEASUREMENTS (RM) TAILLE RÉEL (RM)	APERTURA OPENING OUVERTURE
cm	mm	mm
SILKE 9/9 150	1470-1510	540
SILKE 9/9 160	1570-1610	540
SILKE 9/9 170	1670-1710	600
SILKE 9/9 180	1770-1810	600

SILKE 5

2.040 h

DERECHA · RIGHT · DROITE

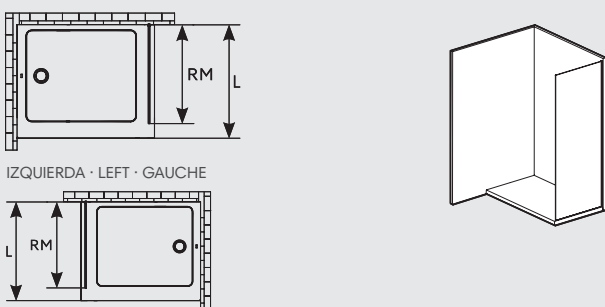

MODELO MODEL MODÈLE	MEDIDA PLATO (L) SIZE OF TRAY (L) MESURES RECEVEUR (L)	MEDIDA REAL (RM) REAL MEASUREMENTS (RM) TAILLE RÉEL (RM)
cm	mm	mm
SILKE 5 70	680-700	675-685
SILKE 5 75	730-750	725-735
SILKE 5 80	780-800	775-785
SILKE 5 90	880-900	875-885

* Instalar junto con SILKE 9C · Install with SILKE 9C · Installer avec SILKE 9C.

SILKE 9B

1.440 h

DERECHA · RIGHT · DROITE

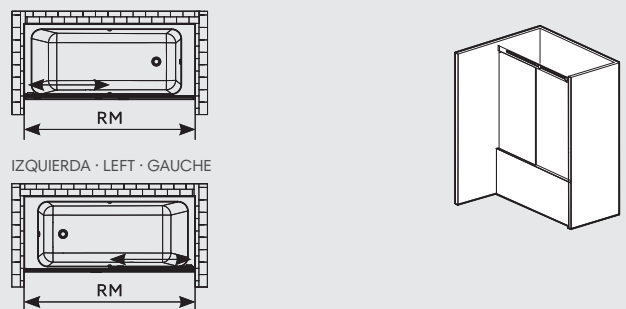

MODELO MODEL MODÈLE	MEDIDA REAL (RM) REAL MEASUREMENTS (RM) TAILLE RÉEL (RM)	APERTURA OPENING OUVERTURE
cm	mm	mm
SILKE 9B 150	1470-1510	630
SILKE 9B 160	1570-1610	630
SILKE 9B 170	1670-1710	700
SILKE 9B 180	1770-1810	700

SILKE 9B C

1.440 h

DERECHA · RIGHT · DROITE

IZQUIERDA · LEFT · GAUCHE

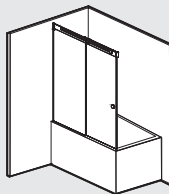
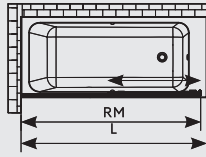
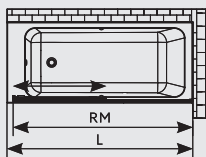

MODELO MODEL MODÈLE	MEDIDA PLATO (L) SIZE OF TRAY (L) MESURES RECEVEUR (L)	MEDIDA REAL (RM) REAL MEASUREMENTS (RM) TAILLE RÉEL (RM)	APERTURA OPENING OUVERTURE
cm	mm	mm	mm
SILKE 9B C 150	1480-1500	1468-1488	620
SILKE 9B C 160	1580-1600	1568-1588	620
SILKE 9B C 170	1680-1700	1668-1688	700
SILKE 9B C 180	1780-1800	1768-1788	700

* Instalar junto con SILKE 5B · Install with SILKE 5B · Installer avec SILKE 5B.

SILKE 9/9B

1.440 h

SIN MANO · NO HAND · SANS SENS

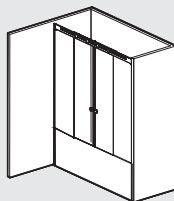
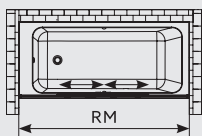

MODELO MODEL MODÈLE	MEDIDA REAL (RM) REAL MEASUREMENTS (RM) TAILLE RÉEL (RM)	APERTURA OPENING OUVERTURE
cm	mm	mm
SILKE 9/9B 150	1470-1510	540
SILKE 9/9B 160	1570-1610	540
SILKE 9/9B 170	1670-1710	600
SILKE 9/9B 180	1770-1810	600
SILKE 9/9B 190	1870-1910	600

SILKE 5B

1.440 h

DERECHA · RIGHT · DROITE

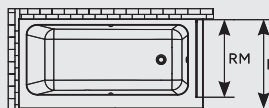

IZQUIERDA · LEFT · GAUCHE

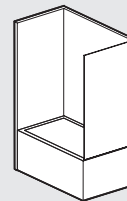
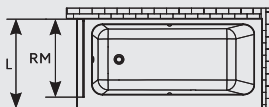

MODELO MODEL MODÈLE	MEDIDA PLATO (L) SIZE OF TRAY (L) MESURES RECEVEUR (L)	MEDIDA REAL (RM) REAL MEASUREMENTS (RM) TAILLE RÉEL (RM)
cm	mm	mm
SILKE 5B 70	680-700	675-685
SILKE 5B 75	730-750	725-735
SILKE 5B 80	780-800	775-785
SILKE 5B 90	880-900	875-885

* Instalar junto con SILKE 9B C · Install with SILKE 9B C · Installer avec SILKE 9B C.

S+LINE

La nueva mampara S+Line está inspirada en la naturaleza, en la realización de una mampara corredera donde las formas delicadas y sinuosas sean las grandes protagonistas. Armonía y funcionalidad han sido los aspectos considerados para desarrollar un producto sencillo con sofisticación estética, adaptable a cualquier tipo de espacio.

Inspired by nature, S+Line is a new sliding shower enclosure conspicuous for its delicate sinuous shapes. Functionality and visual appeal have been given priority in this simple, yet sophisticated looking shower enclosure, suitable for use in shower areas of all kinds.

La nouvelle paroi S+Line puise son inspiration dans la nature, avec la réalisation d'une paroi coulissante dans laquelle les formes délicates et sinueuses jouent le premier rôle. Harmonie et fonctionnalité, tels sont les aspects qui ont été considérés pour le développement d'un produit simple à l'esthétique sophistiquée, adaptable à tout type d'espace.

CRISTALES · GLASS · VERRES

TR transparente
clear
transparent

SystemGlass

Tratamiento fácil limpieza.
Easy clean treatment.
Traitement facile à nettoyer.

SERIGRAFÍAS · GLASS DESIGNS · SÉRIGRAPHIE



FILO



DECO



OPAL



LINE



SERIGRAFÍAS PERSONALIZABLES
CUSTOMIZABLE SCREEN PRINTINGS
SÉRIGRAPHIES PERSONNALISÉS

HERRAJES · FITTINGS · FERRURES

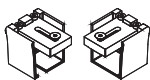

anclaje pared
wall bracket
fixation mur



guía inferior
lower door
guide inférieur



cromo
chrome
chromé



pieza unión guía-cristal
guide-glass joint piece
pièce union guide-vitre



rodamiento
bearing
roulement



negro mate
matt black
noir mat

GUÍA SUPERIOR · TOP GUIDE · GUIDE SUPÉRIEUR



anodizado alto brillo
anodized high gloss
anodisé brillant



negro mate
matt black
noir mat







S+LINE 9+



S+LINE 9C + 5

S+LINE SERIES



S+LINE 9/9



S+LINE 9B



S+LINE 9B C + 5B



S+LINE 9/9B





S+LINE 9 BLACK





S+LINE SERIES

S+LINE 9

2.000 h

DERECHA · RIGHT · DROITE IZQUIERDA · LEFT · GAUCHE

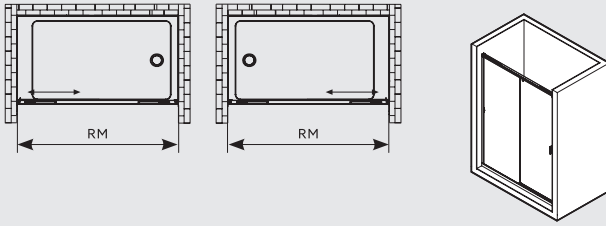

MODELO MODEL MODÈLE	MEDIDA REAL (RM) REAL MEASUREMENTS (RM) TAILLE RÉEL (RM)	APERTURA OPENING OUVERTURE
cm	mm	mm
S+LINE 9 100	980-1005	428
S+LINE 9 110	1080-1105	478
S+LINE 9 120	1180-1205	528
S+LINE 9 130	1280-1305	578
S+LINE 9 140	1380-1405	628
S+LINE 9 150	1480-1505	678
S+LINE 9 160	1580-1605	728
S+LINE 9 170	1680-1705	778
S+LINE 9 180	1780-1805	828

S+LINE 9+

2.000 h

DERECHA · RIGHT · DROITE IZQUIERDA · LEFT · GAUCHE

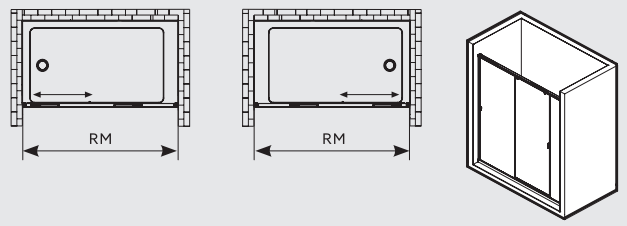

MODELO MODEL MODÈLE	MEDIDA REAL (RM) REAL MEASUREMENTS (RM) TAILLE RÉEL (RM)	APERTURA OPENING OUVERTURE
cm	mm	mm
S+LINE 9+ 140	1370-1410	523
S+LINE 9+150	1470-1510	523
S+LINE 9+160	1570-1610	573
S+LINE 9+170	1670-1710	623
S+LINE 9+180	1770-1810	673

S+LINE 9C

2.000 h

DERECHA · RIGHT · DROITE IZQUIERDA · LEFT · GAUCHE

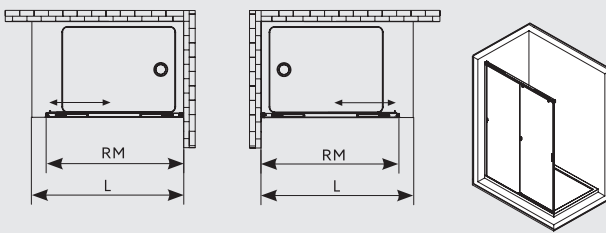

MODELO MODEL MODÈLE	MEDIDA PLATO (L) SIZE OF TRAY (L) MESURES RECEVEUR (L)	MEDIDA REAL (RM) REAL MEASUREMENTS (RM) TAILLE RÉEL (RM)	APERTURA OPENING OUVERTURE
cm	mm	mm	mm
S+LINE 9C 100	980-1000	970-990	410
S+LINE 9C 110	1080-1100	1070-1090	460
S+LINE 9C 120	1180-1200	1170-1190	510
S+LINE 9C 130	1280-1300	1270-1290	560
S+LINE 9C 140	1380-1400	1370-1390	610
S+LINE 9C 150	1480-1500	1470-1490	660
S+LINE 9C 160	1580-1600	1570-1590	710
S+LINE 9C 170	1680-1700	1670-1690	760
S+LINE 9C 180	1780-1800	1770-1790	810

* Instalar junto con S+LINE 5 · Install with S+LINE 5 · Installer avec S+LINE 5.

S+LINE 9/9

2.000 h

SIN MANO · NO HAND · SANS SENS

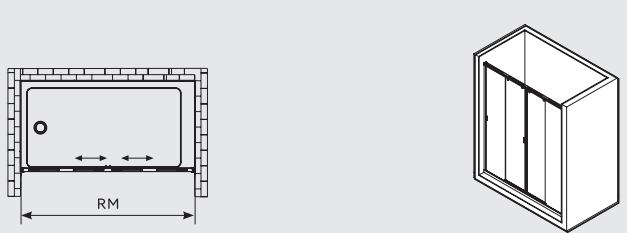

MODELO MODEL MODÈLE	MEDIDA REAL (RM) REAL MEASUREMENTS (RM) TAILLE RÉEL (RM)	APERTURA OPENING OUVERTURE
cm	mm	mm
S+LINE 9/9 160	1570-1610	670
S+LINE 9/9 170	1670-1710	720
S+LINE 9/9 180	1770-1810	770
S+LINE 9/9 190	1870-1910	820

S+LINE 9B

1.500 h

DERECHA · RIGHT · DROITE IZQUIERDA · LEFT · GAUCHE

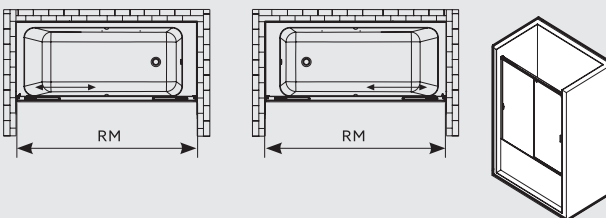

MODELO MODEL MODÈLE	MEDIDA REAL (RM) REAL MEASUREMENTS (RM) TAILLE RÉEL (RM)	APERTURA OPENING OUVERTURE
cm	mm	mm
S+LINE 9B 140	1380-1405	628
S+LINE 9B 150	1480-1505	678
S+LINE 9B 160	1580-1605	728
S+LINE 9B 170	1680-1705	778
S+LINE 9B 180	1780-1805	828
S+LINE 9B 190	1880-1905	878

S+LINE 9B C

1.500 h

DERECHA · RIGHT · DROITE IZQUIERDA · LEFT · GAUCHE

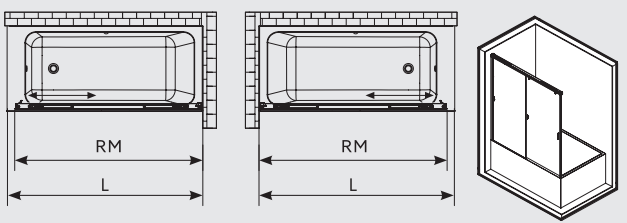

MODELO MODEL MODÈLE	MEDIDA PLATO (L) SIZE OF TRAY (L) MESURES RECEVEUR (L)	MEDIDA REAL (RM) REAL MEASUREMENTS (RM) TAILLE RÉEL (RM)	APERTURA OPENING OUVERTURE
cm	mm	mm	mm
S+LINE 9B C 140	1380-1400	1370-1390	610
S+LINE 9B C 150	1480-1500	1470-1490	660
S+LINE 9B C 160	1580-1600	1570-1590	710
S+LINE 9B C 170	1680-1700	1670-1690	760
S+LINE 9B C 180	1780-1800	1770-1790	810
S+LINE 9B C 190	1880-1900	1870-1890	860

* Instalar junto con S+LINE 5B · Install with S+LINE 5B · Installer avec S+LINE 5B.

S+LINE 9/9B

1.500 h

SIN MANO · NO HAND · SANS SENS

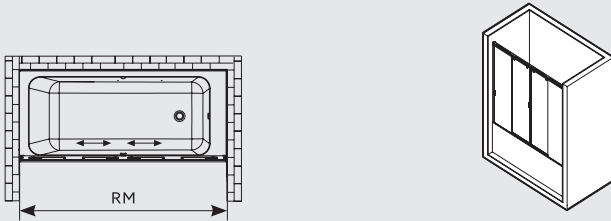

MODELO MODEL MODÈLE	MEDIDA REAL (RM) REAL MEASUREMENTS (RM) TAILLE RÉEL (RM)	APERTURA OPENING OUVERTURE
cm	mm	mm
S+LINE 9/9B 160	1570-1610	670
S+LINE 9/9B 170	1670-1710	720
S+LINE 9/9B 180	1770-1810	770
S+LINE 9/9B 190	1870-1910	820

S+LINE 5

2.000 h

DERECHA · RIGHT · DROITE IZQUIERDA · LEFT · GAUCHE

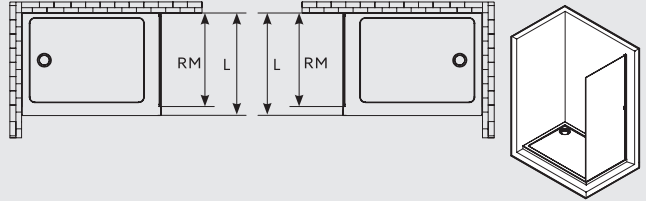

MODELO MODEL MODÈLE	MEDIDA PLATO (L) SIZE OF TRAY (L) MESURES RECEVEUR (L)	MEDIDA REAL (RM) REAL MEASUREMENTS (RM) TAILLE RÉEL (RM)
cm	mm	mm
S+LINE 5 70	680-700	670-690
S+LINE 5 75	730-750	720-740
S+LINE 5 80	780-800	770-790
S+LINE 5 90	880-900	870-890

* Instalar junto con S+LINE 9C · Install with S+LINE 9C · Installer avec S+LINE 9C.

S+LINE 5B

1.500 h

DERECHA · RIGHT · DROITE

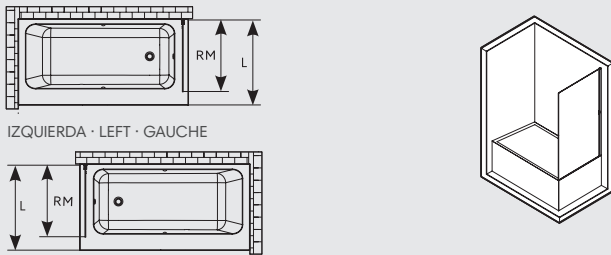

IZQUIERDA · LEFT · GAUCHE

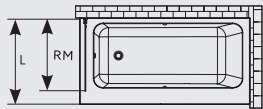

MODELO MODEL MODÈLE	MEDIDA PLATO (L) SIZE OF TRAY (L) MESURES RECEVEUR (L)	MEDIDA REAL (RM) REAL MEASUREMENTS (RM) TAILLE RÉEL (RM)
cm	mm	mm
S+LINE 5B 70	680-700	670-690
S+LINE 5B 75	730-750	720-740
S+LINE 5B 80	780-800	770-790
S+LINE 5B 90	880-900	870-890

* Instalar junto con S+LINE 9B C · Install with S+LINE 9B C · Installer avec S+LINE 9B C.

NEO

La serie NEO se conforma como un ejercicio de pureza formal, destinada a llenar un espacio protagonista por sí sola allí donde se ubique. Versatilidad y vanguardia han sido los aspectos considerados para desarrollar un producto sencillo, adaptable a cualquier tipo de espacio.

The NEO series is an exercise in formal purity, designed to become a focal point in any setting. Versatility and innovation are the key to this simple product that can adapt to any space.

La série NEO est le résultat d'un exercice de pureté formelle et aspire à se mettre au premier plan de toute ambiance, quel que soit l'endroit où elle est posée. Versatilité et avant-garde ont été les aspects pris en considération pour développer un produit simple, qui s'adapte à n'importe quel type d'espace.

CRISTALES · GLASS · VERRES



transparente
clear
transparent



black
mirror

SystemGlass

Tratamiento fácil limpieza.
Easy clean treatment.
Traitement facile à nettoyer.



gris
grey
gris



mate
matt
matt

SERIGRAFÍAS · GLASS DESIGNS · SÉRIGRAPHIE



FILO



DECO



OPAL



LINE



SERIGRAFÍAS PERSONALIZABLES
CUSTOMIZABLE SCREEN PRINTINGS
SÉRIGRAPHIES PERSONNALISÉS

PERFILES · PROFILES · PROFILS



anodizado alto brillo
anodized high gloss
anodisé brillant

TENSORES · TENSORS · TENDEURS

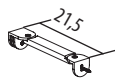
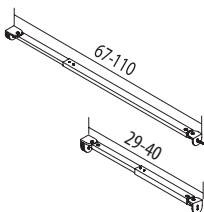

cromo
chrome
chromé

HERRAJES · FITTINGS · FERRURES



180°
double



15°
90°
single



cromo
chrome
chromé







NEO 1



NEO 3







NEO 6



NEO 8



NEO 8C + 5





NEO 9C + 5



NEO 9+



NEO 9/9



NEO P







NEO 2B





NEO 8B



NEO 9/9B

NEO SERIES

NEO 1

2.056 h

DERECHA · RIGHT · DROITE

IZQUIERDA · LEFT · GAUCHE

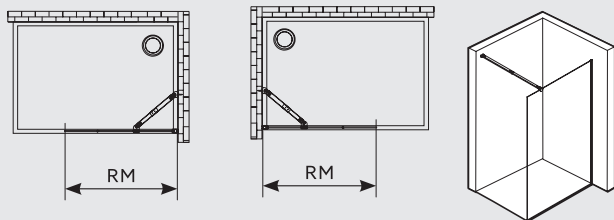

MODELO MODEL MODÈLE	MEDIDA REAL (RM) REAL MEASUREMENTS (RM) TAILLE RÉEL (RM)
cm	mm
NEO 1 70	680-700
NEO 1 80	780-800
NEO 1 90	880-900
NEO 1 100	980-1000
NEO 1 110	1080-1100
NEO 1 120	1180-1200
NEO 1 130	1280-1300
NEO 1 140	1380-1400
NEO 1 150	1480-1500

NEO 2C

2.056 h

SIN MANO · NO HAND · SANS SENS

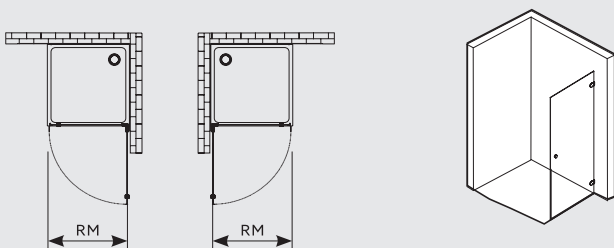

MODELO MODEL MODÈLE	CMEDIDA REAL (RM) REAL MEASUREMENTS (RM) TAILLE RÉEL (RM)	APERTURA OPENING OUVERTURE
cm	mm	mm
NEO 2C 70	670	625
NEO 2C 75	720	675
NEO 2C 80	770	725
NEO 2C 90	870	825

* Instalar junto con NEO 5 · Install with NEO 5 · Installer avec NEO 5.

NEO 6

2.056 h

SIN MANO · NO HAND · SANS SENS

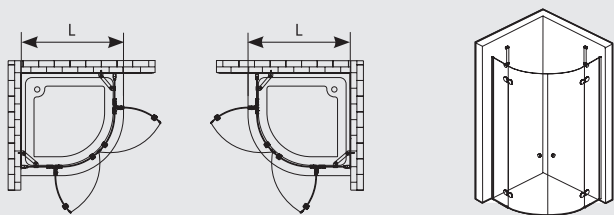

MODELO MODEL MODÈLE	MEDIDA PLATO (L) SIZE OF TRAY (L) MESURES RECEVEUR (L)	APERTURA OPENING OUVERTURE
cm	mm	mm
NEO 6 80	780-800	795
NEO 6 90	880-900	795
NEO 6 100	980-1000	795

NEO 2

2.056 h

SIN MANO · NO HAND · SANS SENS

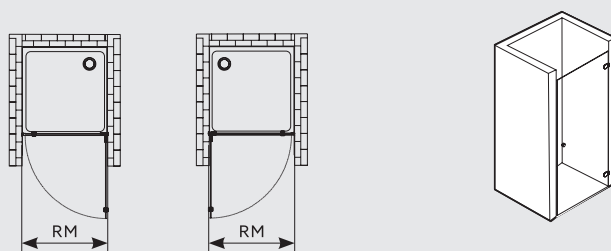

MODELO MODEL MODÈLE	MEDIDA REAL (RM) REAL MEASUREMENTS (RM) TAILLE RÉEL (RM)	APERTURA OPENING OUVERTURE
cm	mm	mm
NEO 2 80	785-795	725
NEO 2 90	885-895	825

NEO 3

2.056 h

DERECHA · RIGHT · DROITE

IZQUIERDA · LEFT · GAUCHE

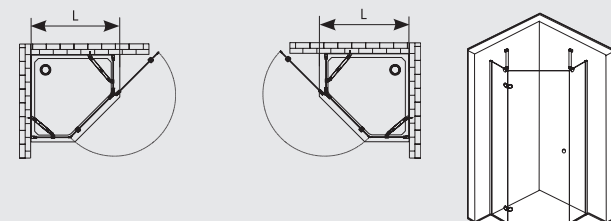

MODELO MODEL MODÈLE	MEDIDA PLATO (L) SIZE OF TRAY (L) MESURES RECEVEUR (L)	APERTURA OPENING OUVERTURE
cm	mm	mm
NEO 3 90	880-900	635
NEO 3 100	980-1000	635

NEO 8

2.056 h

SIN MANO · NO HAND · SANS SENS

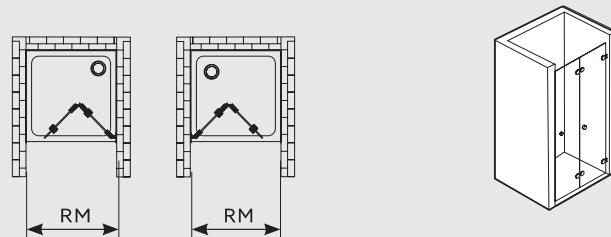

MODELO MODEL MODÈLE	CMEDIDA REAL (RM) REAL MEASUREMENTS (RM) TAILLE RÉEL (RM)	APERTURA OPENING OUVERTURE
cm	mm	mm
NEO 8 70	680-690	600
NEO 8 75	730-740	650
NEO 8 80	780-790	700
NEO 8 90	880-890	800

NEO 4

2.056 h

DERECHA · RIGHT · DROITE

IZQUIERDA · LEFT · GAUCHE

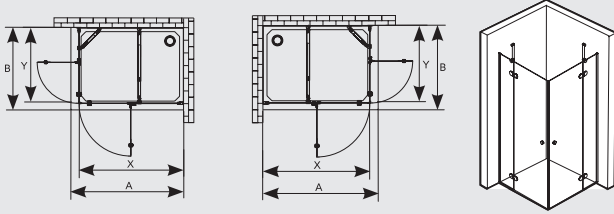

MODELO MODEL MODÈLE	MEDIDA PLATO (AxB) SIZE OF TRAY (AxB) MESURES RECEVEUR (AxB)	MEDIDA REAL (XxY) REAL MEASUREMENTS (XxY) TAILLE RÉEL (XxY)	APERTURA OPENING OUVERTURE
cm	mm	mm	mm
NEO 4 70x70	680-700 x 680-700	660-680 x 660-680	720
NEO 4 75x75	730-750 x 730-750	710-730 x 710-730	720
NEO 4 80x80	780-800 x 780-800	760-780 x 760-780	720
NEO 4 90x90	880-900 x 880-900	860-880 x 860-880	720
NEO 4 75x70	730-750 x 680-700	710-730 x 660-680	720
NEO 4 80x70	780-800 x 680-700	760-780 x 660-680	720
NEO 4 80x75	780-800 x 730-750	760-780 x 710-730	720
NEO 4 90x70	880-900 x 680-700	860-880 x 660-680	720
NEO 4 90x75	880-900 x 730-750	860-880 x 710-730	720
NEO 4 90x80	880-900 x 780-800	860-880 x 760-780	720
NEO 4 100x70	980-1000 x 680-700	960-980 x 660-680	720
NEO 4 100x75	980-1000 x 730-750	960-980 x 710-730	720
NEO 4 100x80	980-1000 x 780-800	960-980 x 760-780	720
NEO 4 100x90	980-1000 x 880-900	960-980 x 860-880	720
NEO 4 110x70	1080-1100 x 680-700	1060-1080 x 660-680	720
NEO 4 110x75	1080-1100 x 730-750	1060-1080 x 710-730	720
NEO 4 110x80	1080-1100 x 780-800	1060-1080 x 760-780	720
NEO 4 110x90	1080-1100 x 880-900	1060-1080 x 860-880	720
NEO 4 120x70	1180-1200 x 680-700	1160-1180 x 660-680	720
NEO 4 120x75	1180-1200 x 730-750	1160-1180 x 710-730	720
NEO 4 120x80	1180-1200 x 780-800	1160-1180 x 760-780	720
NEO 4 120x90	1180-1200 x 880-900	1160-1180 x 860-880	720

NEO 9

2.056 h

DERECHA · RIGHT · DROITE

IZQUIERDA · LEFT · GAUCHE

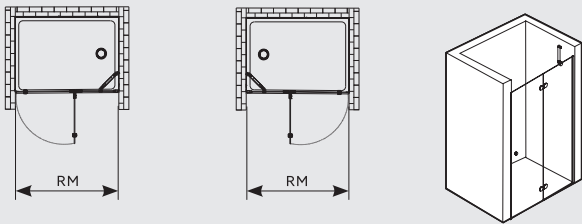

MODELO MODEL MODÈLE	MEDIDA REAL (RM) REAL MEASUREMENTS (RM) TAILLE RÉEL (RM)	APERTURA OPENING OUVERTURE
cm	mm	mm
NEO 9 80	780-810	590
NEO 9 90	880-910	590
NEO 9 100	980-1010	590
NEO 9 110	1080-1110	590
NEO 9 120	1080-1210	590
NEO 9 130	1280-1310	590
NEO 9 140	1380-1410	590
NEO 9 150	1480-1510	590

NEO 8C

2.056 h

SIN MANO · NO HAND · SANS SENS

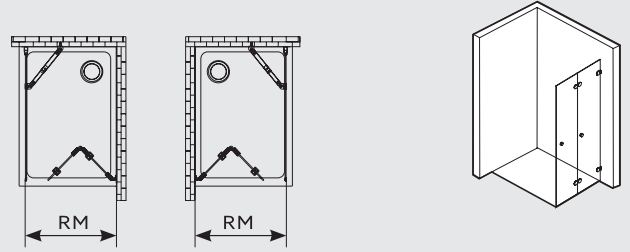

MODELO MODEL MODÈLE	MEDIDA REAL (RM) REAL MEASUREMENTS (RM) TAILLE RÉEL (RM)	APERTURA OPENING OUVERTURE
cm	mm	mm
NEO 8C 70	670	600
NEO 8C 75	720	650
NEO 8C 80	770	700
NEO 8C 90	870	800

* Instalar junto con NEO 5 · Install with NEO 5 · Installer avec NEO 5.

NEO 9C

2.056 h

DERECHA · RIGHT · DROITE

IZQUIERDA · LEFT · GAUCHE

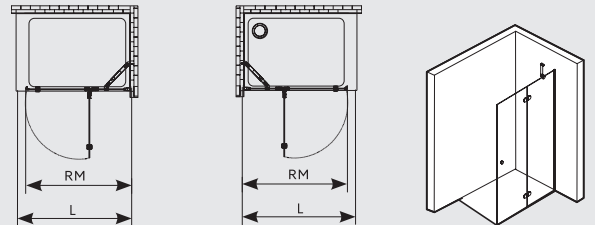

MODELO MODEL MODÈLE	MEDIDA PLATO (L) SIZE OF TRAY (L) MESURES RECEVEUR (L)	MEDIDA REAL (RM) REAL MEASUREMENTS (RM) TAILLE RÉEL (RM)	APERTURA OPENING OUVERTURE
cm	mm	mm	mm
NEO 9C 80	780-800	773-793	580
NEO 9C 90	880-900	873-893	580
NEO 9C 100	980-1000	973-993	580
NEO 9C 110	1080-1100	1073-1093	580
NEO 9C 120	1180-1200	1173-1193	580
NEO 9C 130	1280-1300	1273-1293	580
NEO 9C 140	1380-1400	1373-1393	580
NEO 9C 150	1480-1500	1473-1493	580

* Instalar junto con NEO 5 · Install with NEO 5 · Installer avec NEO 5.

NEO SERIES

NEO 9+

2.056 h

DERECHA · RIGHT · DROITE

IZQUIERDA · LEFT · GAUCHE

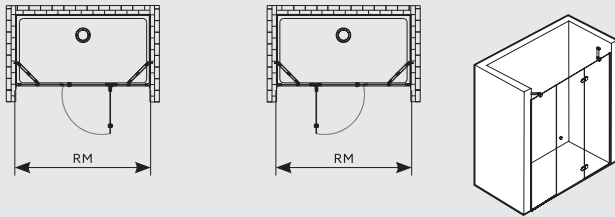

MODELO MODEL MODÈLE	MEDIDA REAL (RM) REAL MEASUREMENTS (RM) TAILLE RÉEL (RM)	APERTURA OPENING OUVERTURE
cm	mm	mm
NEO 9+ 120	1170-1210	590
NEO 9+ 130	1270-1310	590
NEO 9+ 140	1370-1410	590
NEO 9+ 150	1470-1510	590
NEO 9+ 160	1570-1610	590
NEO 9+ 170	1670-1710	590
NEO 9+ 180	1770-1810	590

NEO 9/9

2.056 h

SIN MANO · NO HAND · SANS SENS

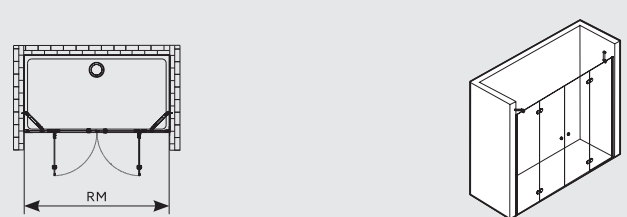

MODELO MODEL MODÈLE	MEDIDA REAL (RM) REAL MEASUREMENTS (RM) TAILLE RÉEL (RM)	APERTURA OPENING OUVERTURE
cm	mm	mm
NEO 9/9 150	1470-1510	960
NEO 9/9 160	1570-1610	960
NEO 9/9 170	1670-1710	960
NEO 9/9 180	1770-1810	960
NEO 9/9 190	1870-1910	960

NEO 10

2.056 h

DERECHA · RIGHT · DROITE

IZQUIERDA · LEFT · GAUCHE

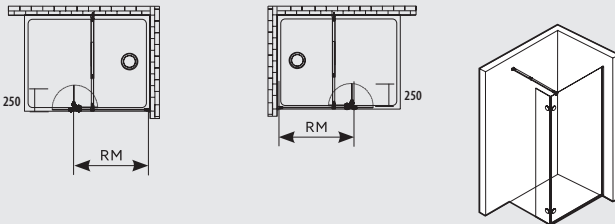

MODELO MODEL MODÈLE	MEDIDA REAL (RM) REAL MEASUREMENTS (RM) TAILLE RÉEL (RM)	APERTURA OPENING OUVERTURE
cm	mm	mm
NEO 10 140	820-840	540
NEO 10 150	920-940	540
NEO 10 160	1020-1040	540
NEO 10 170	1120-1140	540
NEO 10 180	1220-1240	540

NEO P

2.056 h

SIN MANO · NO HAND · SANS SENS

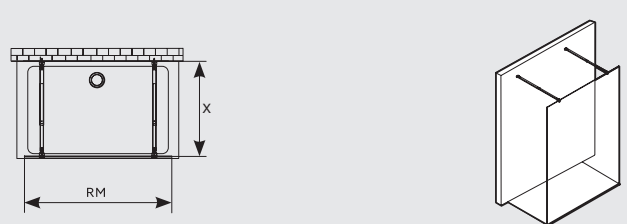

X= 700 - 1100 mm.

MODELO MODEL MODÈLE	MEDIDA REAL (RM) REAL MEASUREMENTS (RM) TAILLE RÉEL (RM)
cm	mm
NEO P 120	1175
NEO P 140	1375

NEO P10

2.056 h

SIN MANO · NO HAND · SANS SENS

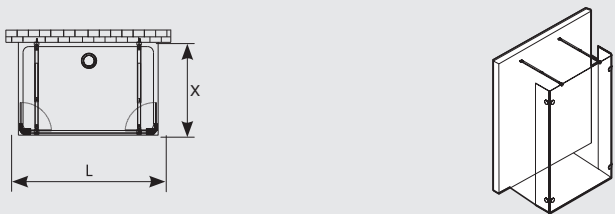

X= 700-1100 mm.

MODELO MODEL MODÈLE	MEDIDA REAL (RM) REAL MEASUREMENTS (RM) TAILLE RÉEL (RM)
cm	mm
NEO P10 120	1135
NEO P10 140	1335

NEO 5

2.056 h

DERECHA · RIGHT · DROITE

IZQUIERDA · LEFT · GAUCHE

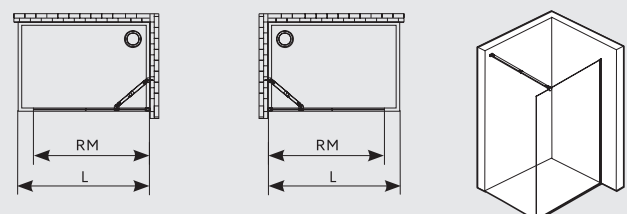

MODELO MODEL MODÈLE	MEDIDA PLATO (L) SIZE OF TRAY (L) MESURES RECEVEUR (L)	MEDIDA REAL (RM) REAL MEASUREMENTS (RM) TAILLE RÉEL (RM)
cm	mm	mm
NEO 5 70	680-700	668-688
NEO 5 75	730-750	718-738
NEO 5 80	780-800	768-788
NEO 5 90	880-900	868-888
NEO 5 100	980-1000	968-988
NEO 5 110	1080-1100	1068-1088
NEO 5 120	1180-1200	1168-1188

* Instalar junto con NEO 2C/8C/9C - Install with NEO 2C/8C/9C -
Installer avec NEO 2C/8C/9C.

NEO 2B

1.500 h

DERECHA · RIGHT · DROITE

IZQUIERDA · LEFT · GAUCHE

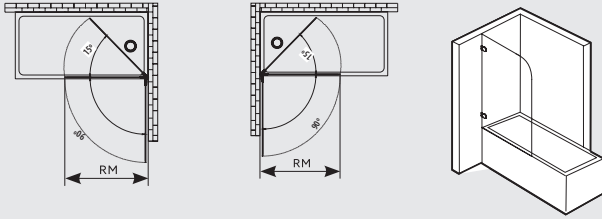

MODELO MODEL MODÈLE	MEDIDA REAL (RM) REAL MEASUREMENTS (RM) TAILLE RÉEL (RM)	APERTURA OPENING OUVERTURE
cm	mm	mm
NEO 2B 80	800	780
NEO 2B 90	900	880

NEO 2B+

1.500 h

DERECHA · RIGHT · DROITE

IZQUIERDA · LEFT · GAUCHE

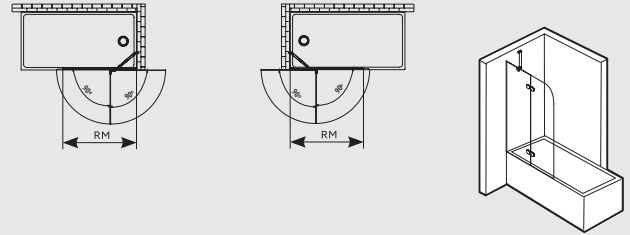

MODELO MODEL MODÈLE	MEDIDA REAL (RM) REAL MEASUREMENTS (RM) TAILLE RÉEL (RM)	APERTURA OPENING OUVERTURE
cm	mm	mm
NEO 2B+ 100	990-1010	780
NEO 2B+110	1090-1110	780
NEO 2B+120	1190-1210	780

NEO 8B

1.500 h

DERECHA · RIGHT · DROITE

IZQUIERDA · LEFT · GAUCHE

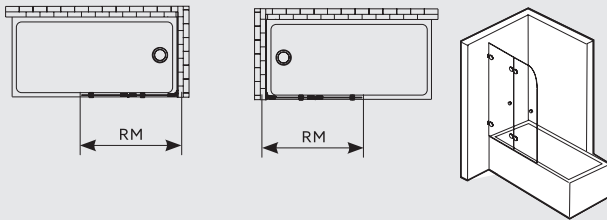

MODELO MODEL MODÈLE	MEDIDA REAL (RM) REAL MEASUREMENTS (RM) TAILLE RÉEL (RM)	APERTURA OPENING OUVERTURE
cm	mm	mm
NEO 8B 90	900	820
NEO 8B 100	1000	920

NEO 9/9B

1.500 h

SIN MANO · NO HAND · SANS SENS

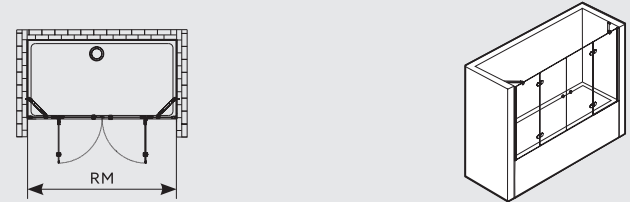

MODELO MODEL MODÈLE	MEDIDA REAL (RM) REAL MEASUREMENTS (RM) TAILLE RÉEL (RM)	APERTURA OPENING OUVERTURE
cm	mm	mm
NEO 9/9B 150	1470-1510	960
NEO 9/9B 160	1570-1610	960
NEO 9/9B 170	1670-1710	960
NEO 9/9B 180	1770-1810	960
NEO 9/9B 190	1870-1910	960

DECA

Amplia mampara con puertas correderas provistas de sistema SoftClose para asegurar un uso cómodo y silencioso. Disponible con cristal transparente de 10 mm para el cristal fijo y 8 mm para la puerta corredera, también cuenta con una robusta perfilería de aluminio en acabado anodizado satinado. Se puede encontrar en diferentes medidas y modelos para cubrir un extenso abanico de composiciones a fin de solucionar cualquier necesidad que se presente.

A large shower enclosure with sliding doors fitted with the silent easy-glide SoftClose system. Available with 10mm-thick transparent glass for the fixed panel of glass and 8mm-thick transparent glass for the sliding doors. It also features tough aluminium profiles in a satin anodized aluminium finish. The Deca comes in varying different sizes and models, ensuring a wide range of compositions able to meet all possible needs.

Ample paroi de douche avec portes coulissantes dotées du système Soft Close pour garantir un usage commode et silencieux. Disponible avec verre transparent de 10 mm pour le verre fixe et 8 mm pour la porte coulissante, et un profilé en aluminium robuste, avec une finition en aluminium anodisé satiné. Existe dans différentes mesures et modèles pour couvrir un large éventail de compositions afin de répondre à tous les cas de figure.

CRISTALES · GLASS · VERRES



TR

transparente
clear
transparent



mate
mate
matt

SystemGlass

Tratamiento fácil limpieza.
Easy clean treatment.
Traitement facile à nettoyer.

SERIGRAFÍAS · GLASS DESIGNS · SÉRIGRAPHIE



FILO



DECO



OPAL



LINE



SERIGRAFÍAS PERSONALIZABLES
CUSTOMIZABLE SCREEN PRINTINGS
SÉRIGRAPHIES PERSONNALISÉS

HERRAJES · FITTINGS · FERRURES



anclaje pared
wall bracket
fixation mur



tirador
handle
poignée



cromados satinados
satin chrome finish
chrome satiné

GUÍA SUPERIOR · TOP GUIDE · GUIDE SUPÉRIEUR



aluminio anodizado satinados
satin anodized aluminium
aluminium anodisé satiné







DECA 9 + 5



DECA 9/9



DECA 9B



DECA 9/9B

DECA SERIES

DECA 9

2.000 h

SIN MANO · NO HAND · SANS SENS

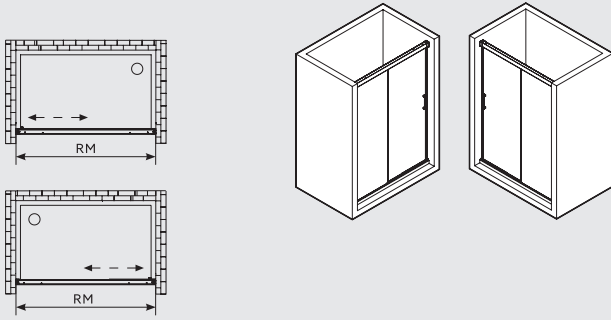

MODELO MODEL MODÈLE	MEDIDA REAL (RM) REAL MEASUREMENTS (RM) TAILLE RÉEL (RM)	APERTURA OPENING OUVERTURE
cm	mm	mm
DECA 9 100	970 - 1005	390
DECA 9 110	1070 - 1105	440
DECA 9 120	1170 - 1205	490
DECA 9 130	1270 - 1305	540
DECA 9 140	1370 - 1405	590
DECA 9 150	1470 - 1505	640
DECA 9 160	1570 - 1605	690
DECA 9 170	1670 - 1705	740
DECA 9 180	1770 - 1805	790

DECA 5

2.000 h

SIN MANO · NO HAND · SANS SENS

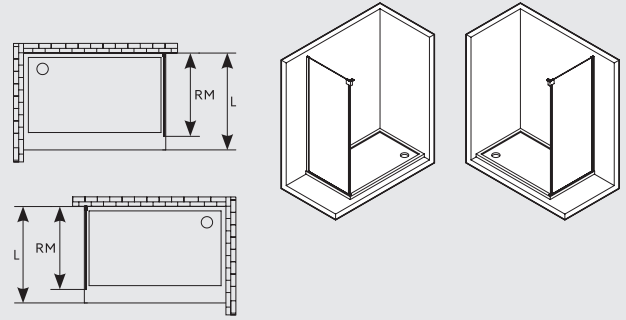

MODELO MODEL MODÈLE	MEDIDA PLATO (L) SIZE OF TRAY (L) MESURES RECEVEUR (L)	MEDIDA REAL (RM) REAL MEASUREMENTS (RM) TAILLE RÉEL (RM)
cm	mm	mm
DECA 5 70	685 - 700	677 - 697
DECA 5 75	735 - 750	727 - 747
DECA 5 80	785 - 800	777 - 797
DECA 5 90	885 - 900	877 - 897

* Instalar junto con DECA 9 · Install with DECA 9 · Installer avec DECA 9.

DECA 9 + 5

2.000 h

SIN MANO · NO HAND · SANS SENS

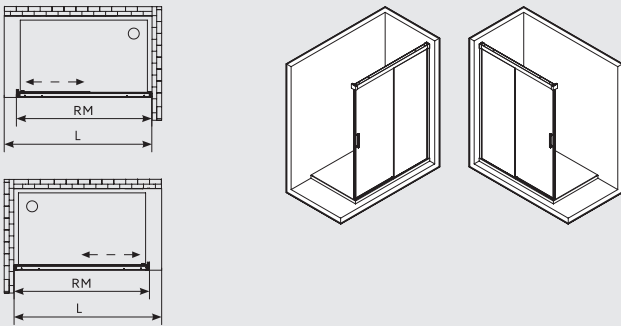

MODELO MODEL MODÈLE	MEDIDA PLATO (L) SIZE OF TRAY (L) MESURES RECEVEUR (L)	MEDIDA REAL (RM) REAL MEASUREMENTS (RM) TAILLE RÉEL (RM)	APERTURA OPENING OUVERTURE
cm	mm	mm	mm
DECA 9+5 100	985 - 1005	979 - 999	390
DECA 9+5 110	1085 - 1105	1079 - 1099	440
DECA 9+5 120	1185 - 1205	1179 - 1199	490
DECA 9+5 130	1285 - 1305	1279 - 1299	540
DECA 9+5 140	1385 - 1405	1379 - 1399	590
DECA 9+5 150	1485 - 1505	1479 - 1499	640
DECA 9+5 160	1585 - 1605	1579 - 1599	690
DECA 9+5 170	1685 - 1705	1679 - 1699	740
DECA 9+5 180	1785 - 1805	1779 - 1799	790

DECA 9/9

2.000 h

SIN MANO · NO HAND · SANS SENS

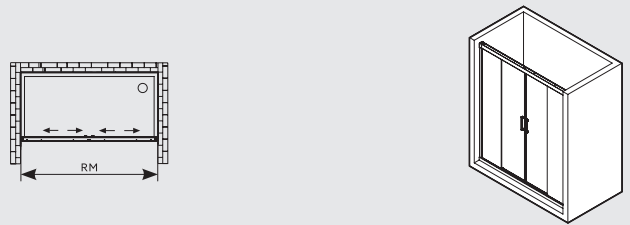

MODELO MODEL MODÈLE	MEDIDA REAL (RM) REAL MEASUREMENTS (RM) TAILLE RÉEL (RM)	APERTURA OPENING OUVERTURE
cm	mm	mm
DECA 9/9 160	1570 - 1610	610
DECA 9/9 170	1670 - 1710	660
DECA 9/9 180	1770 - 1810	710

* Esta mampara puede instalarse con DECA 5 · This enclosure can be installed with DECA 5 · Cette paroi peut être installée avec DECA 5.

DECA 9B

1.550 h

SIN MANO · NO HAND · SANS SENS

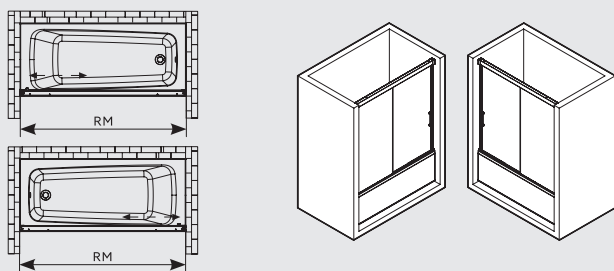

MODELO MODEL MODÈLE	MEDIDA REAL (RM) REAL MEASUREMENTS (RM) TAILLE RÉEL (RM)	APERTURA OPENING OUVERTURE
cm	mm	mm
DECA 9B 150	1470 - 1505	640
DECA 9B 160	1570 - 1605	690
DECA 9B 170	1670 - 1705	740

DECA 5B

1.550 h

SIN MANO · NO HAND · SANS SENS

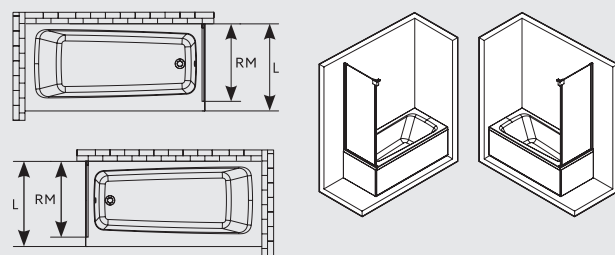

MODELO MODEL MODÈLE	MEDIDA PLATO (L) SIZE OF TRAY (L) MESURES RECEVEUR (L)	MEDIDA REAL (RM) REAL MEASUREMENTS (RM) TAILLE RÉEL (RM)
cm	mm	mm
DECA 5B 70	685 - 700	677 - 697
DECA 5B 80	785 - 800	777 - 797
DECA 5B 90	885 - 900	877 - 897

* Instalar junto con DECA 9 · Install with DECA 9 · Installer avec DECA 9.

DECA 9B + 5B

1.550 h

SIN MANO · NO HAND · SANS SENS

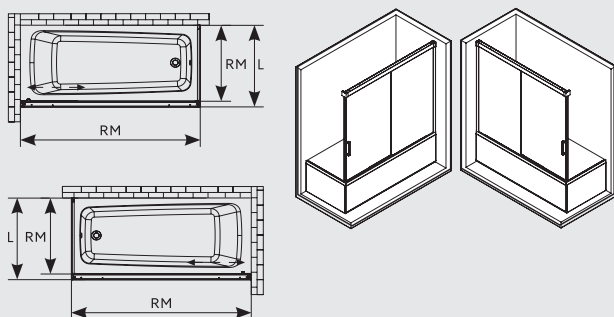

MODELO MODEL MODÈLE	MEDIDA PLATO (L) SIZE OF TRAY (L) MESURES RECEVEUR (L)	MEDIDA REAL (RM) REAL MEASUREMENTS (RM) TAILLE RÉEL (RM)	APERTURA OPENING OUVERTURE
cm	mm	mm	mm
DECA 9B+5B 150	1485 - 1505	1479 - 1499	640
DECA 9B+5B 160	1585 - 1605	1579 - 1599	690
DECA 9B+5B 170	1670 - 1705	1679 - 1699	740

DECA 9/9B

1.550 h

SIN MANO · NO HAND · SANS SENS

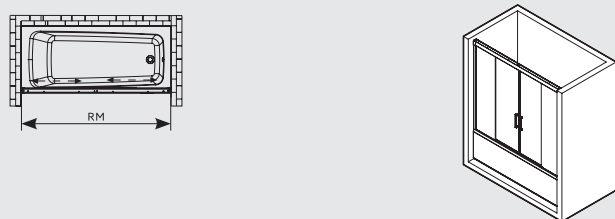

MODELO MODEL MODÈLE	MEDIDA REAL (RM) REAL MEASUREMENTS (RM) TAILLE RÉEL (RM)	APERTURA OPENING OUVERTURE
cm	mm	mm
DECA 9/9B 170	1670 - 1710	660
DECA 9/9B 180	1770 - 1810	710
DECA 9/9B 190	1870 - 1910	760

* Esta mampara puede instalarse con DECA 5B · This enclosure can be installed with DECA 5B · Cette paroi peut être installée avec DECA 5B.

YOVE

La colección de mamparas YOVE nace con un espíritu minimalista y actual, con sencillez en sus líneas de diseño sin renunciar por ello a un funcionamiento robusto.

La colección se presenta en diferentes formatos y tamaños para cumplir con los diferentes requisitos, con dos alturas: mamparas de 1950 mm para de platos de ducha y 1450 mm para bañeras.

YOVE is the collection of bath and shower enclosures that stands out for its up-to-date, minimalist design, without relinquishing robust strength.

The collection comes in a choice of different formats and sizes to meet varying requirements, with two heights: 1950mm enclosures for shower trays and 1450mm ones for baths.

La collection de parois YOVE voit le jour dans un esprit minimaliste et actuel, caractérisé par la simplicité de ses lignes, mais sans renoncer pour autant à la robustesse.

Elle est disponible en différents formats répondant parfaitement à la demande du marché. La paroi est fabriquée en deux hauteurs, 1950 mm pour les receveurs de douche et 1450 pour les baignoires.

CRISTALES · GLASS · VERRES

TR

transparente
clear
transparent



black
mirror*

SystemGlass

Tratamiento fácil limpieza.
Easy clean treatment.
Traitement facile à nettoyer.

* Sólo modelo Yove 1 · Only Yove 1 model · Uniquement modèles Yove 1

SERIGRAFÍAS · GLASS DESIGNS · SÉRIGRAPHIE



FILO



DECO



OPAL



LINE



SERIGRAFÍAS PERSONALIZABLES
CUSTOMIZABLE SCREEN PRINTINGS
SÉRIGRAPHIES PERSONNALISÉS

PERFILES · PROFILES · PROFILS



aluminio alto brillo
high brightness aluminium
aluminium haut brillante

GUÍA SUPERIOR · TOP GUIDE · GUIDE SUPÉRIEUR

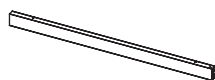

aluminio alto brillo
high brightness aluminium
aluminium haut brillante

TENSORES · TENSORS · TENDEURS

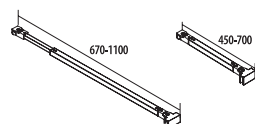

inox brillo
gloss inox
inox brillante



romo
chrome
chromé

HERRAJES · FITTINGS · FERRURES







YOVE 4



YOVE 6





YOVE 9C + 5





YOVE 9+



YOVE 9B

YOVE SERIES

YOVE 1

1.950 h

DERECHA · RIGHT · DROITE

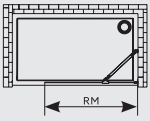

IZQUIERDA · LEFT · GAUCHE

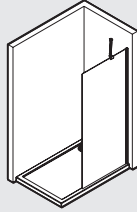
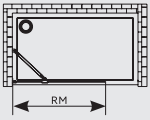

MODELO MODEL MODÈLE	MEDIDA REAL (RM) REAL MEASUREMENTS (RM) TAILLE RÉEL (RM)
cm	mm
YOVE 1 80	790-800
YOVE 1 90	890-900
YOVE 1 100	990-1000
YOVE 1 110	1090-1100
YOVE 1 120	1190-1200
YOVE 1 130	1290-1300
YOVE 1 140	1390-1400
YOVE 1 150	1490-1500

YOVE 6

1.950 h

SIN MANO · NO HAND · SANS SENS

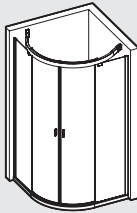
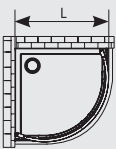

MODELO MODEL MODÈLE	MEDIDA PLATO (L) SIZE OF TRAY (L) MESURES RECEVEUR (L)	MEDIDA REAL (RM) REAL MEASUREMENTS (RM) TAILLE RÉEL (RM)
cm	mm	mm
YOVE 6 80	785-805	390
YOVE 6 90	885-905	470
YOVE 6 100	985-1005	570

YOVE 9C

1.950 h

DERECHA · RIGHT · DROITE

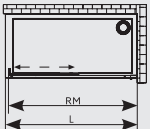

IZQUIERDA · LEFT · GAUCHE

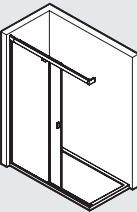
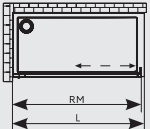

MODELO MODEL MODÈLE	MEDIDA PLATO (L) SIZE OF TRAY (L) MESURES RECEVEUR (L)	MEDIDA REAL (RM) REAL MEASUREMENTS (RM) TAILLE RÉEL (RM)	APERTURA OPENING OUVERTURE
cm	mm	mm	mm
YOVE 9C 100	985-1005	970-990	390
YOVE 9C 110	1085-1105	1070-1090	440
YOVE 9C 120	1185-1205	1170-1190	490
YOVE 9C 130	1285-1305	1270-1290	540
YOVE 9C 140	1385-1405	1370-1390	590
YOVE 9C 150	1485-1505	1470-1490	640
YOVE 9C 160	1585-1605	1570-1590	690
YOVE 9C 170	1685-1705	1670-1690	740
YOVE 9C 180	1785-1805	1770-1790	790

YOVE 4

1.950 h

DERECHA · RIGHT · DROITE

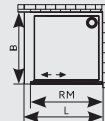

IZQUIERDA · LEFT · GAUCHE

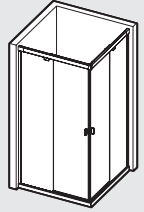
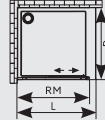

MODELO MODEL MODÈLE	MEDIDA PLATO (L) SIZE OF TRAY (L) MESURES RECEVEUR (L)	MEDIDA REAL (RM) REAL MEASUREMENTS (RM) TAILLE RÉEL (RM)
cm	mm	mm
YOVE 4 70	685-705	666-686
YOVE 4 75	735-755	716-736
YOVE 4 80	785-805	766-786
YOVE 4 90	885-905	866-886
YOVE 4 100	985-1005	966-986
YOVE 4 110	1085-1105	1066-1086
YOVE 4 120	1185-1205	1166-1186
YOVE 4 140	1385-1405	1366-1386

YOVE 9

1.950 h

DERECHA · RIGHT · DROITE

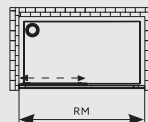

IZQUIERDA · LEFT · GAUCHE

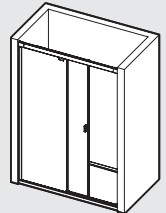
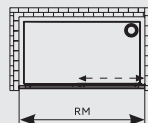

MODELO MODEL MODÈLE	MEDIDA REAL (RM) REAL MEASUREMENTS (RM) TAILLE RÉEL (RM)	APERTURA OPENING OUVERTURE
cm	mm	mm
YOVE 9 100	970-1010	410
YOVE 9 110	1070-1110	460
YOVE 9 120	1170-1210	510
YOVE 9 130	1270-1310	560
YOVE 9 140	1370-1410	610
YOVE 9 150	1470-1510	660
YOVE 9 160	1570-1610	710
YOVE 9 170	1670-1710	760
YOVE 9 180	1770-1810	810

YOVE 9/9

1.950 h

SIN MANO · NO HAND · SANS SENS

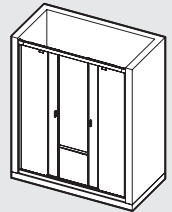
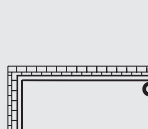

MODELO MODEL MODÈLE	MEDIDA REAL (RM) REAL MEASUREMENTS (RM) TAILLE RÉEL (RM)	APERTURA OPENING OUVERTURE
cm	mm	mm
YOVE 9/9 150	1470-1510	560
YOVE 9/9 160	1570-1610	610
YOVE 9/9 170	1670-1710	660
YOVE 9/9 180	1770-1810	710

* Instalar junto con YOVE 5 · Install with YOVE 5 · Installer avec YOVE 5.

YOVE 9+

1.950 h

DERECHA · RIGHT · DROITE

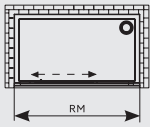

IZQUIERDA · LEFT · GAUCHE

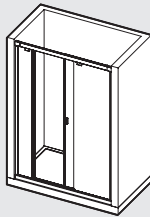
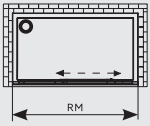

MODELO MODEL MODÈLE	MEDIDA REAL (RM) REAL MEASUREMENTS (RM) TAILLE RÉEL (RM)	APERTURA OPENING OUVERTURE
cm	mm	mm
YOVE 9+ 140	1370 - 1410	490
YOVE 9+ 150	1470 - 1510	500
YOVE 9+ 160	1570 - 1610	550
YOVE 9+ 170	1670 - 1710	600
YOVE 9+ 180	1770 - 1810	650

YOVE 5

1.950 h

DERECHA · RIGHT · DROITE

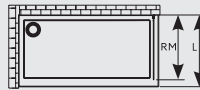

IZQUIERDA · LEFT · GAUCHE

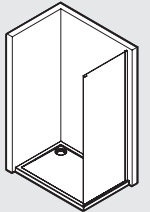
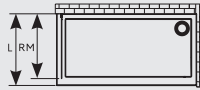

MODELO MODEL MODÈLE	MEDIDA PLATO (L) SIZE OF TRAY (L) MESURES RECEVEUR (L)	MEDIDA REAL (RM) REAL MEASUREMENTS (RM) TAILLE RÉEL (RM)
cm	mm	mm
YOVE 5 70	685 - 705	672 - 692
YOVE 5 75	735 - 755	722 - 742
YOVE 5 80	785 - 805	772 - 792
YOVE 5 90	885 - 905	872 - 892

* Instalar junto con YOVE 9C · Install with YOVE 9C · Installer avec YOVE 9C.

YOVE 9B

1.450 h

DERECHA · RIGHT · DROITE

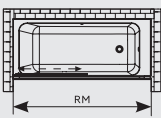

IZQUIERDA · LEFT · GAUCHE

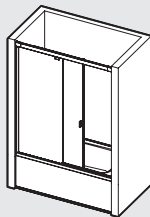
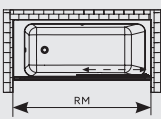

MODELO MODEL MODÈLE	MEDIDA REAL (RM) REAL MEASUREMENTS (RM) TAILLE RÉEL (RM)	APERTURA OPENING OUVERTURE
cm	mm	mm
YOVE 9B 140	1370 - 1410	610
YOVE 9B 150	1470 - 1510	660
YOVE 9B 160	1570 - 1610	710
YOVE 9B 170	1670 - 1710	760
YOVE 9B 180	1770 - 1810	810
YOVE 9B 190	1870 - 1910	810

YOVE 9B C

1.450 h

DERECHA · RIGHT · DROITE

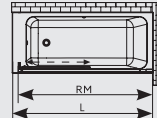

IZQUIERDA · LEFT · GAUCHE

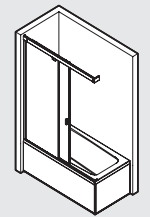
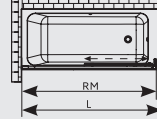

MODELO MODEL MODÈLE	MEDIDA PLATO (L) SIZE OF TRAY (L) MESURES RECEVEUR (L)	MEDIDA REAL (RM) REAL MEASUREMENTS (RM) TAILLE RÉEL (RM)	APERTURA OPENING OUVERTURE
cm	mm	mm	mm
YOVE 9B C 140	1385 - 1405	1370 - 1390	590
YOVE 9B C 150	1485 - 1505	1470 - 1490	640
YOVE 9B C 160	1585 - 1605	1570 - 1590	690
YOVE 9B C 170	1685 - 1705	1670 - 1690	740
YOVE 9B C 180	1785 - 1805	1770 - 1790	790
YOVE 9B C 190	1885 - 1905	1870 - 1890	790

* Instalar junto con YOVE 5B · Install with YOVE 5B · Installer avec YOVE 5B.

YOVE 9/9B

1.450 h

SIN MANO · NO HAND · SANS SENS

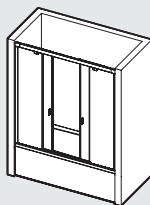
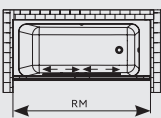

MODELO MODEL MODÈLE	MEDIDA REAL (RM) REAL MEASUREMENTS (RM) TAILLE RÉEL (RM)	APERTURA OPENING OUVERTURE
cm	mm	mm
YOVE 9/9B 150	1470 - 1510	560
YOVE 9/9B 160	1570 - 1610	610
YOVE 9/9B 170	1670 - 1710	660
YOVE 9/9B 180	1770 - 1810	710
YOVE 9/9B 190	1870 - 1910	760

YOVE 5B

1.450 h

DERECHA · RIGHT · DROITE

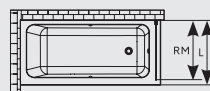

IZQUIERDA · LEFT · GAUCHE

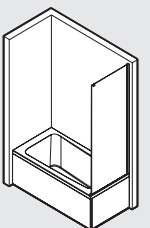
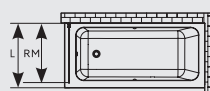

MODELO MODEL MODÈLE	MEDIDA PLATO (L) SIZE OF TRAY (L) MESURES RECEVEUR (L)	MEDIDA REAL (RM) REAL MEASUREMENTS (RM) TAILLE RÉEL (RM)
cm	mm	mm
YOVE 5B 70	685 - 705	672 - 692
YOVE 5B 75	735 - 755	722 - 742
YOVE 5B 80	785 - 805	772 - 792
YOVE 5B 90	885 - 905	872 - 892

INTER

Equipada con rodamientos articulados, perfiles de compensación a pared y cierres magnéticos. Cristales templados de máxima seguridad 6 mm.

Equipped with compensation profiles and magnetic seals. 6 mm high-safety tempered glass.

Paroi avec profiles de compensation, joints d'étanchéité et fermeture magnétique. Verre trempé securit de 6 mm.

CRISTALES · GLASS · VERRES



TR

transparente
transparent
transparent

PERFILES · PROFILES · PROFILS



aluminio anodizado brillo
aluminium gloss anodized
aluminium anodysé brillante

TENSORES · TENSORS · TENDEURS

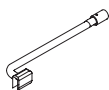

inox brillo
gloss inox
inox brillant

HERRAJES · FITTINGS · FERRURES



chromo
chrome
chromé













INTER 9



INTER 2B

INTER SERIES

INTER 1

1.900 h

SIN MANO · NO HAND · SANS SENS

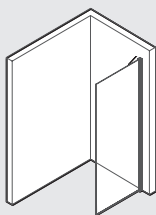
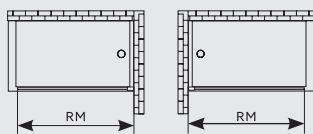

MODELO MODEL MODÈLE	MEDIDA REAL (RM) REAL MEASUREMENTS (RM) TAILLE RÉEL (RM)
cm	mm
INTER 1 80	780 - 800
INTER 1 90	880 - 900

INTER 2

1.900 h

SIN MANO · NO HAND · SANS SENS

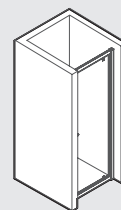
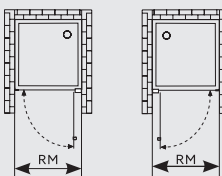

MODELO MODEL MODÈLE	MEDIDA REAL (RM) REAL MEASUREMENTS (RM) TAILLE RÉEL (RM)	APERTURA OPENING OUVERTURE
cm	mm	mm
INTER 2 70	670-710	541
INTER 2 75	720-760	591
INTER 2 80	770-810	641
INTER 2 85	820-860	691
INTER 2 90	870-910	741

* Esta mampara puede instalarse con INTER 5 · This enclosure can be installed with INTER 5 · Cette paroi peut être installée avec INTER 5.

INTER 2 + 5

1.900 h

SIN MANO · NO HAND · SANS SENS

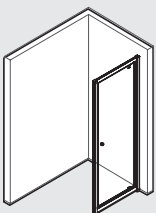
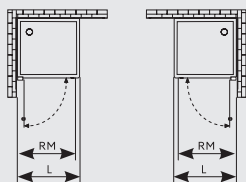

MODELO MODEL MODÈLE	MEDIDA PLATO (L) SIZE OF TRAY (L) MESURES RECEVEUR (L)	MEDIDA REAL (RM) REAL MEASUREMENTS (RM) TAILLE RÉEL (RM)	APERTURA OPENING OUVERTURE
cm	mm	mm	mm
INTER 2 70	685-705	677-697	541
INTER 2 75	735-755	727-747	591
INTER 2 80	785-805	777-797	641
INTER 2 85	835-855	827-847	691
INTER 2 90	885-905	877-897	741

* Esta mampara puede instalarse con INTER 5 · This enclosure can be installed with INTER 5 · Cette paroi peut être installée avec INTER 5.

INTER 2+

1.900 h

SIN MANO · NO HAND · SANS SENS

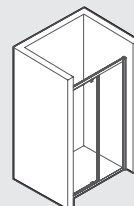
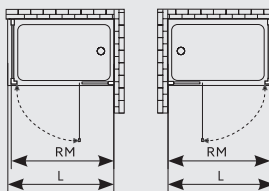

MODELO MODEL MODÈLE	MEDIDA REAL (RM) REAL MEASUREMENTS (RM) TAILLE RÉEL (RM)	APERTURA OPENING OUVERTURE
cm	mm	mm
INTER 2+ 100	970-1010	460
INTER 2+ 110	1070-1110	460
INTER 2+ 120	1170-1210	460

* Esta mampara puede instalarse con INTER 5 · This enclosure can be installed with INTER 5 · Cette paroi peut être installée avec INTER 5.

INTER 2+ + 5
1.900 h

SIN MANO · NO HAND · SANS SENS

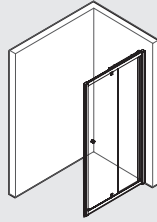
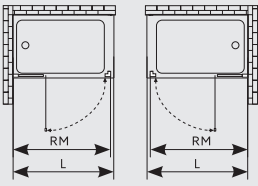

MODELO MODEL MODÈLE	MEDIDA PLATO (L) SIZE OF TRAY (L) MESURES RECEVEUR (L)	MEDIDA REAL (RM) REAL MEASUREMENTS (RM) TAILLE RÉEL (RM)	APERTURA OPENING OUVERTURE
cm	mm	mm	mm
INTER 2+ 100	985-1005	977-997	460
INTER 2+ 110	1085-1105	1077-1097	460
INTER 2+ 120	1185-1205	1177-1197	460

* Esta mampara puede instalarse con **INTER 5** · This enclosure can be installed with **INTER 5** · Cette paroi peut être installée avec **INTER 5**.

INTER 3
1.900 h

SIN MANO · NO HAND · SANS SENS

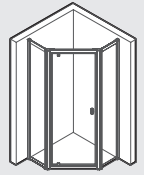
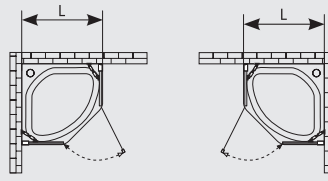

MODELO MODEL MODÈLE	MEDIDA PLATO (L) SIZE OF TRAY (L) MESURES RECEVEUR (L)	APERTURA OPENING OUVERTURE
cm	mm	mm
INTER 3 90	880-910	460
INTER 3 100	980-1010	460

INTER 4
1.900 h

SIN MANO · NO HAND · SANS SENS

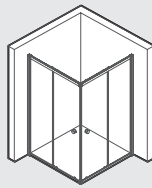
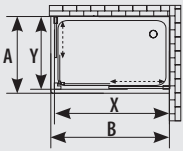

MODELO MODEL MODÈLE	MEDIDA PLATO (A*B) SIZE OF TRAY (A*B) MESURES RECEVEUR (A*B)	MEDIDA REAL (X*Y) REAL MEASUREMENTS (X*Y) TAILLE RÉEL (X*Y)
cm	mm	mm
INTER 4 70	670-690	660-680
INTER 4 75	720-740	710-730
INTER 4 80	770-790	760-780
INTER 4 90	870-890	860-880
INTER 4 100	970-990	960-980
INTER 4 110	1070-1090	1060-1080
INTER 4 120	1170-1190	1160-1180
INTER 4 130	1270-1290	1260-1280
INTER 4 140	1370-1390	1360-1380

INTER 6
1.900 h

SIN MANO · NO HAND · SANS SENS

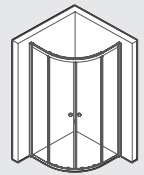
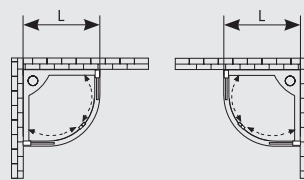

MODELO MODEL MODÈLE	MEDIDA PLATO (L) SIZE OF TRAY (L) MESURES RECEVEUR (L)	APERTURA OPENING OUVERTURE
cm	mm	mm
INTER 6 75	725-745	360
INTER 6 80	775-795	450
INTER 6 90	875-895	600
INTER 6 100	975-995	600

INTER SERIES

INTER 8

1.900 h

SIN MANO · NO HAND · SANS SENS

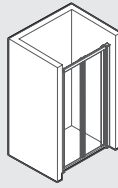
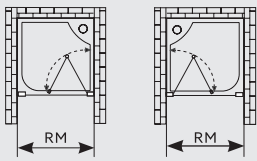

MODELO MODEL MODÈLE	MEDIDA REAL (RM) REAL MEASUREMENTS (RM) TAILLE RÉEL (RM)	APERTURA OPENING OUVERTURE
cm	mm	mm
INTER 8 70	670-710	480
INTER 8 75	720-760	530
INTER 8 80	770-810	580
INTER 8 85	820-860	630
INTER 8 90	870-910	680
INTER 8 100	970-1010	780

* Esta mampara puede instalarse con INTER 5 · This enclosure can be installed with INTER 5 · Cette paroi peut être installée avec INTER 5.

INTER 8 + 5

1.900 h

SIN MANO · NO HAND · SANS SENS

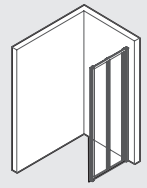
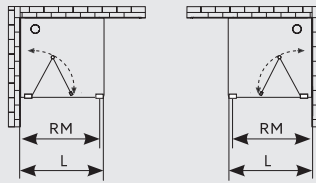

MODELO MODEL MODÈLE	MEDIDA PLATO (L) SIZE OF TRAY (L) MESURES RECEVEUR (L)	MEDIDA REAL (RM) REAL MEASUREMENTS (RM) TAILLE RÉEL (RM)	APERTURA OPENING OUVERTURE
cm	mm	mm	mm
INTER 8 70	685-705	677-697	480
INTER 8 75	735-755	727-747	530
INTER 8 80	785-805	777-797	580
INTER 8 85	835-855	827-847	630
INTER 8 90	885-905	877-897	680
INTER 8 100	985-1005	977-997	780

* Esta mampara puede instalarse con INTER 5 · This enclosure can be installed with INTER 5 · Cette paroi peut être installée avec INTER 5.

INTER 9

1.900 h

SIN MANO · NO HAND · SANS SENS

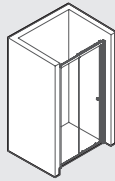
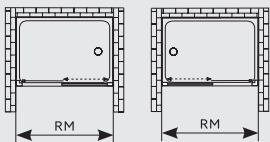

MODELO MODEL MODÈLE	MEDIDA REAL (RM) REAL MEASUREMENTS (RM) TAILLE RÉEL (RM)	APERTURA OPENING OUVERTURE
cm	mm	mm
INTER 9 100	970-1010	380
INTER 9 110	1070-1110	430
INTER 9 120	1170-1210	480
INTER 9 130	1270-1310	530
INTER 9 140	1370-1410	580
INTER 9 150	1470-1510	630
INTER 9 160	1570-1610	630
INTER 9 170	1670-1710	630

* Esta mampara puede instalarse con INTER 5 · This enclosure can be installed with INTER 5 · Cette paroi peut être installée avec INTER 5.

INTER 9 + 5

1.900 h

SIN MANO · NO HAND · SANS SENS

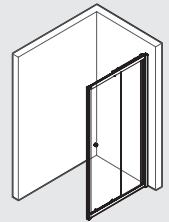
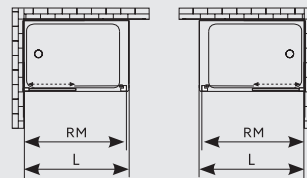

MODELO MODEL MODÈLE	MEDIDA PLATO (L) SIZE OF TRAY (L) MESURES RECEVEUR (L)	MEDIDA REAL (RM) REAL MEASUREMENTS (RM) TAILLE RÉEL (RM)	APERTURA OPENING OUVERTURE
cm	mm	mm	mm
INTER 9 100	985-1005	977-997	380
INTER 9 110	1085-1105	1077-1097	430
INTER 9 120	1185-1205	1177-1197	480
INTER 9 130	1285-1305	1277-1297	530
INTER 9 140	1385-1405	1377-1397	580
INTER 9 150	1485-1505	1477-1497	630
INTER 9 160	1585-1605	1577-1597	630
INTER 9 170	1685-1705	1677-1697	630

* Esta mampara puede instalarse con INTER 5 · This enclosure can be installed with INTER 5 · Cette paroi peut être installée avec INTER 5.

INTER 5
1.900 h

SIN MANO · NO HAND · SANS SENS

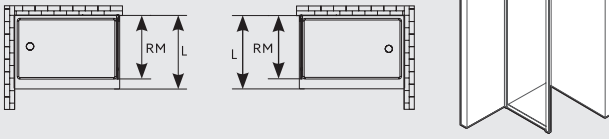

MODELO MODEL MODÈLE	MEDIDA PLATO (L) SIZE OF TRAY (L) MESURES RECEVEUR (L)	MEDIDA REAL (RM) REAL MEASUREMENTS (RM) TAILLE RÉEL (RM)
cm	mm	mm
INTER 5 70	670-690	660-680
INTER 5 75	720-740	710-730
INTER 5 80	770-790	760-780
INTER 5 85	820-840	810-830
INTER 5 90	870-890	860-880

* Para instalar con **INTER 8**, **INTER 2**, **INTER 2 +** o **INTER 9** · For installing with **INTER 8**, **INTER 2**, **INTER 2 +** or **INTER 9** · Pour installer avec **INTER 8**, **INTER 2**, **INTER 2 +** ou **INTER 9**.

INTER 2B
1.465 h

SIN MANO · NO HAND · SANS SENS

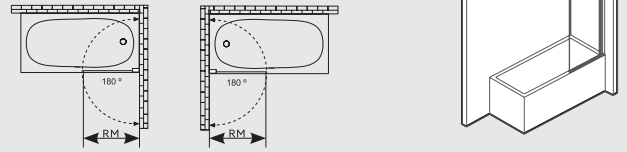

MODELO MODEL MODÈLE	MEDIDA REAL (RM) REAL MEASUREMENTS (RM) TAILLE RÉEL (RM)	APERTURA OPENING OUVERTURE
cm	mm	mm
INTER 2B 80	790 - 800	770
INTER 2B 85	840 - 850	820

OPTIMA

Nueva familia de mamparas con diseño minimalista que va de suelo a techo. Con cristal templado de seguridad de 8 ó 10 mm de espesor, con tratamiento fácil limpieza (System-Glass) aplicado en el mismo.

Mampara con una gran versatilidad para cubrir cualquier tipo de hueco gracias a sus diferentes modelos (fijos, puertas, parabanes o fijo+puerta) y un altura máxima de 2500 mm. Al tratarse de una mampara enmarcada, le otorga una gran resistencia y robustez al conjunto.

New series of screens with a minimalist design that reaches from floor to ceiling. With 8 mm or 10 mm thickness tempered safety glass, with easy to clean treatment (System-Glass) applied to it.

Shower screen with a great versatility to cover any type of space thanks to its different models (fixed, doors, paraban or fixed+door) and a maximum height of 2500 mm. Being a framed screen, it provides great resistance and robustness to the assembly.

Nouvelle série de parois au design minimaliste toute hauteur. Avec du verre de sécurité trempé de 8 mm ou 10 mm d'épaisseur, sur lequel est appliqué un traitement de nettoyage facile (System-Glass). Paroi d'une grande polyvalence pour couvrir tout type d'espace grâce à ses différents modèles (fixe, portes, paraban ou fixe+porte) et une hauteur maximale de 2500 mm. Comme c'est une paroi encadrée, elle donne une grande résistance et robustesse au décor.

CRISTALES · GLASS · VERRES



transparente
clear
transparent



bronce
bronze
bronze



black
mirror



gris
grey
gris



mate
mate
matt

SystemGlass

Tratamiento fácil limpieza.
Easy clean treatment.
Traitement facile à nettoyer.

SERIGRAFÍAS · GLASS DESIGNS · SÉRIGRAPHIE



FILO



DECO



OPAL



LINE



SERIGRAFÍAS PERSONALIZABLES
CUSTOMIZABLE SCREEN PRINTINGS
SÉRIGRAPHIES PERSONNALISÉS

PERFILES · PROFILES · PROFILS



brillo
gloss
brillante



negro mate
matt black
noir mat







OPTIMA 2 CHROME · TRANSPARENT





OPTIMA 9 + 1 BLACK · GREY



OPTIMA 1

2200 - 2500 h

DERECHA · RIGHT · DROITE

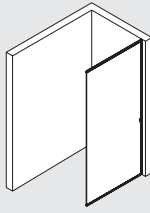
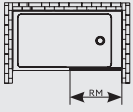

IZQUIERDA · LEFT · GAUCHE

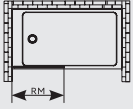

MEDIDA REAL (RM) REAL MEASUREMENTS (RM) TAILLE RÉEL (RM)	ALTURA MÁXIMA MAXIMUM HEIGHT HAUTEUR MAXIMALE
mm	mm
500 - 999	2500
1000 - 1500	2500

OPTIMA 2

2151 - 2400h / 1900 - 2150h

DERECHA · RIGHT · DROITE

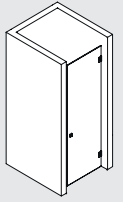
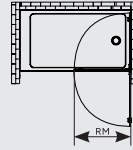

IZQUIERDA · LEFT · GAUCHE

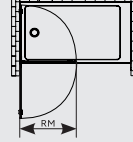

MEDIDA REAL (RM) REAL MEASUREMENTS (RM) TAILLE RÉEL (RM)	ALTURA MÁXIMA MAXIMUM HEIGHT HAUTEUR MAXIMALE
mm	mm
500 - 650	2400
500 - 750	2150

OPTIMA 9

2200 - 2500 h

DERECHA · RIGHT · DROITE

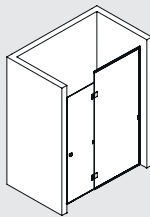
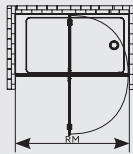

IZQUIERDA · LEFT · GAUCHE

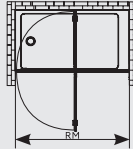

MEDIDA REAL (RM) REAL MEASUREMENTS (RM) TAILLE RÉEL (RM)	ALTURA MÁXIMA MAXIMUM HEIGHT HAUTEUR MAXIMALE
mm	mm
800 - 1299	2500
1300 - 1799	2500
1800 - 2200	2500







JAVA

Mampara de línea minimalista que por su simplicidad, resistencia y funcionalidad la convierten en una de las mamparas de ducha más deseables y cómodas de usar, con un seguro y robusto funcionamiento. Disponible en un exclusivo color negro.

Minimalist style enclosure whose simplicity, strength and functionality make it one of the most desirable and user-friendly shower enclosures, with a safe and sturdy operating mechanism. Available in an exclusive black colour.

Grâce à sa simplicité, sa résistance et sa fonctionnalité, cette paroi de douche aux lignes minimalistes est l'une des plus recherchées et faciles à utiliser, avec un fonctionnement sûr et résistant. Disponible en noir exclusivement.

CRISTALES · GLASS · VERRES

	transparente clear transparent		transparente Frame clear Frame transparent Frame		gris grey gris		black mirror
	transparente Grid clear Grid transparent Grid		bronze bronze bronze		mate mate matt	SystemGlass Tratamiento fácil limpieza. Easy clean treatment. Traitement facile à nettoyer.	

SERIGRAFÍAS · GLASS DESIGNS · SÉRIGRAPHIE

	FILO		DECO		OPAL		LINE		SERIGRAFÍAS PERSONALIZABLES CUSTOMIZABLE SCREEN PRINTINGS SÉRIGRAPHIES PERSONNALISÉS
---	------	---	------	---	------	---	------	---	--

PERFILES · PROFILES · PROFILS

		negro mate matt black noir mat
---	---	--------------------------------------

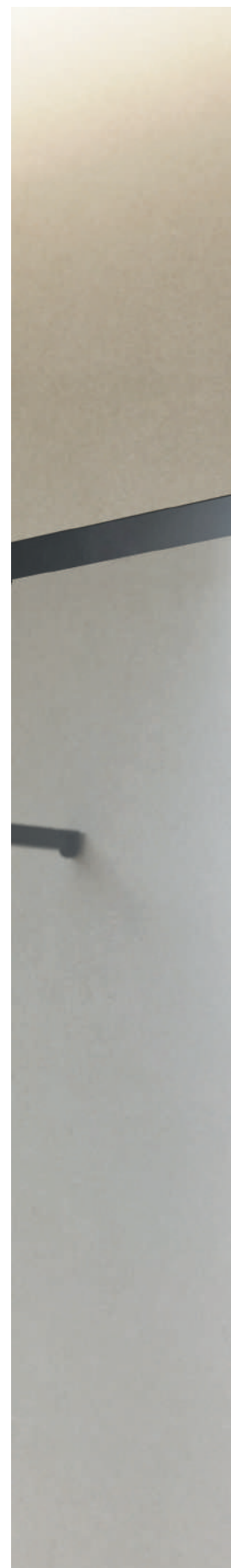





JAVA 1 · MATT BLACK · TRANSPARENT



JAVA 1 · MATT BLACK · TRANSPARENT GRID



JAVA 1 · MATT BLACK · TRANSPARENT GRID



JAVA P · MATT BLACK · TRANSPARENT FRAME



JAVA P · MATT BLACK · TRANSPARENT GRID

JAVA 1
1950 h

transparente · transparente · **TR**

DERECHA · RIGHT · DROITE

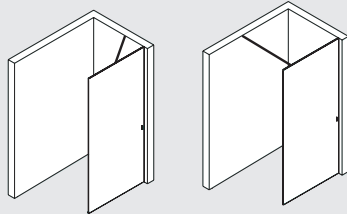
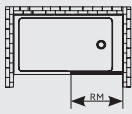

400-985

986-1600

IZQUIERDA · LEFT · GAUCHE

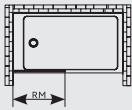

MODELO MODEL MODÈLE	MEDIDA REAL (RM) REAL MEASUREMENTS (RM) TAILLE RÉEL (RM)
cm	mm
JAVA 1 70	690-700
JAVA 1 80	790-800
JAVA 1 90	890-900
JAVA 1 100	990-1000
JAVA 1 110	1090-1100
JAVA 1 120	1190-1200
JAVA 1 130	1290-1300
JAVA 1 140	1390-1400
JAVA 1 150	1490-1500

JAVA 1
1950 h

transparente frame · transparent frame · transparent frame

DERECHA · RIGHT · DROITE

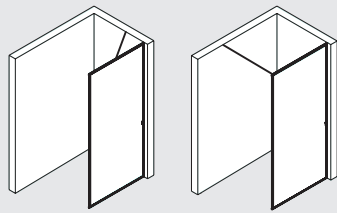
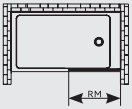

400-985

986-1600

IZQUIERDA · LEFT · GAUCHE

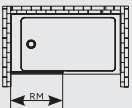

MODELO MODEL MODÈLE	MEDIDA REAL (RM) REAL MEASUREMENTS (RM) TAILLE RÉEL (RM)
cm	mm
JAVA 1 70	690-700
JAVA 1 80	790-800
JAVA 1 90	890-900
JAVA 1 100	990-1000
JAVA 1 110	1090-1100
JAVA 1 120	1190-1200
JAVA 1 130	1290-1300
JAVA 1 140	1390-1400
JAVA 1 150	1490-1500

JAVA P
1950 h

transparente grid · transparent grid · transparent grid

SIN MANO · NO HAND · SANS SENS

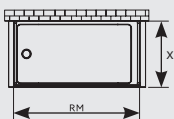

X = 700-1100 mm.

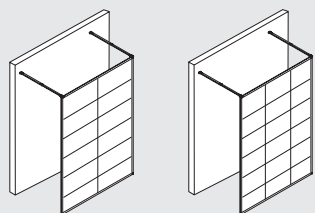

1000-1349

1350-1500

MODELO MODEL MODÈLE	MEDIDA REAL (RM) REAL MEASUREMENTS (RM) TAILLE RÉEL (RM)
cm	mm
JAVA P 120	1185
JAVA P 140	1385

JAVA 1
1950 h

transparente grid · transparent grid · transparent grid

DERECHA · RIGHT · DROITE

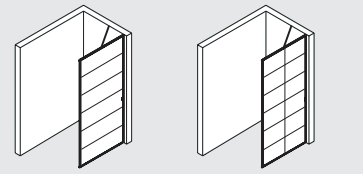
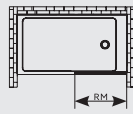

400-799

800-985

IZQUIERDA · LEFT · GAUCHE

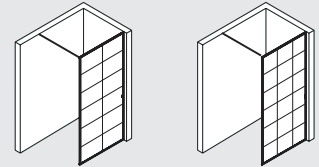
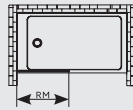

986-1349

1350-1600

MODELO MODEL MODÈLE	MEDIDA REAL (RM) REAL MEASUREMENTS (RM) TAILLE RÉEL (RM)
cm	mm
JAVA 1 70	690-700
JAVA 1 80	790-800
JAVA 1 90	890-900
JAVA 1 100	990-1000
JAVA 1 110	1090-1100
JAVA 1 120	1190-1200
JAVA 1 130	1290-1300
JAVA 1 140	1390-1400
JAVA 1 150	1490-1500

JAVA P
1950 h

transparente · transparent · transparent

SIN MANO · NO HAND · SANS SENS

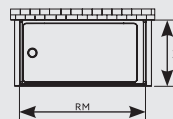

X = 700-1100 mm.

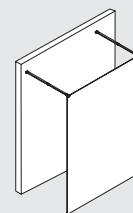

MODELO MODEL MODÈLE	MEDIDA REAL (RM) REAL MEASUREMENTS (RM) TAILLE RÉEL (RM)
cm	mm
JAVA P 120	1185
JAVA P 140	1385

JAVA P
1950 h

transparente frame · transparent frame · transparent frame

SIN MANO · NO HAND · SANS SENS

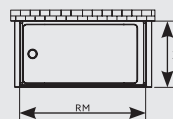

X = 700-1100 mm.

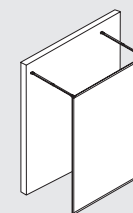

1000-1349

MODELO MODEL MODÈLE	MEDIDA REAL (RM) REAL MEASUREMENTS (RM) TAILLE RÉEL (RM)
cm	mm
JAVA P 120	1185
JAVA P 140	1385

PLANE accessories

Accesorios de mampara fabricados en acero inoxidable para la colocación de utensilios de baño.

Shower enclosure accessories made of stainless steel for shower products.

Accessoires de parois en acier inoxydable pour y déposer les objets nécessaires pour la douche.

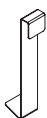

Perchero Plane
Plane hanger
Portemanteau Plane

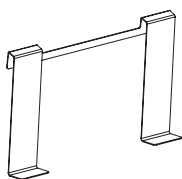

Perchero Plane Due
Plane Due Hanger
Portemanteau Due Plane

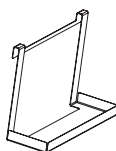

Portagel Plane
Holder Plane
Porte-Gel De Douche





SystemGlass

El acabado System-Glass consiste en un tratamiento transparente, incoloro e inocuo. En los vidrios tratados con System-Glass el agua desliza fácil y rápidamente por la superficie prolongando por más tiempo un aspecto limpio y brillante. System-Glass disminuye las deposiciones de jabón y cal sobre el cristal tratado, mantiene la transparencia natural del mismo, minimiza la carga bacteriana y facilita la limpieza, sin necesidad de recurrir a procedimientos agresivos y abrasivos.

El tratamiento System-Glass es estable y duradero en el tiempo, cumpliendo con los más altos estándares de calidad del mercado. Este tratamiento esta certificado y avalado por laboratorios certificados externos a KRION SOLID SURFACE.

System-Glass is a transparent, colourless, innocuous treatment for glass. Once glass surfaces have been treated with it, System-glass ensures that water runs swiftly and easily across the surface of the glass, prolonging its clean, shiny appearance. System-glass reduces the lime scale, soapsuds and bacteria that build up on glass, conserving its natural transparency. Likewise, it facilitates the cleaning process by avoiding the need for aggressive, abrasive cleaning methods.

System-Glass is a long-lasting stable treatment, designed to meet the highest quality standards on the market. The treatment is certified and guaranteed by external laboratories.

La finition System-Glass consiste en un traitement transparent, incolore et inoffensif. Sur les verres traités par le système System-Glass, l'eau coule facilement et rapidement sur la surface, et l'aspect propre et brillant de ces derniers dure plus longtemps. System-Glass réduit les dépôts de savon et de tartre sur le verre traité, préserve la transparence naturelle de ce dernier, réduit la charge bactérienne et facilite les opérations de nettoyage sans devoir recourir à des méthodes agressives et abrasives.

Le traitement System-Glass est stable et durable dans le temps; il répond par ailleurs aux plus hautes exigences de qualité du marché. Ce traitement est certifié et avalisé par des laboratoires agréés indépendants étrangers à KRION SOLID SURFACE.



CRISTALES GLASS · VERRES

TR transparente
clear
transparent

black
mirror

bronze
bronze
bronze

gris
grey
gris

mate
mate
matt

SystemGlass
Tratamiento fácil limpieza.
Easy clean treatment.
Traitement facile à nettoyer.

ELIJE TU SERIGRAFÍA
GLASS FINISH · CHOISISSEZ VOTRE SÉRIGRAPHIE



LINE



DECO



OPAL



FILO

Acabados

Finish · Finitions

Mamparas · Enclosures · Parois

Cristales

Glasses

Verres



transparente
transparent
transparent

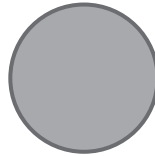

gris
grey
gris



BLACK
MIRROR

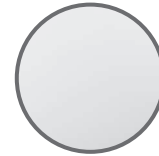

mate
mate
matt

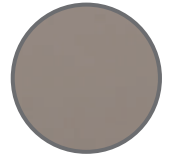

bronce
bronze
bronze

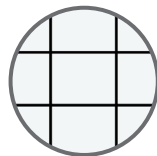

transparente Grid
clear Grid
transparent Grid

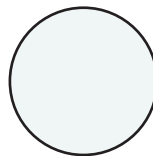

transparente Frame
clear Frame
transparent Frame

Serigrafía

Serigraphy

Sérigraphies

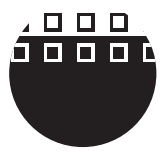

DECO



LINE



FILO

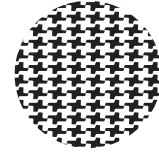

OPAL



SERIGRAFÍAS PERSONALIZABLES

CUSTOMIZABLE SCREEN PRINTINGS

SÉRIGRAPHIES PERSONNALISÉS

Krion ofrece la posibilidad de hacer serigrafías/dibujos especiales ·
Krion offers the possibility of making special screen printings/drawings ·
Krion vous offre la possibilité de créer sérigraphies /dessins spéciaux

Metales

Metallic

Métalliques

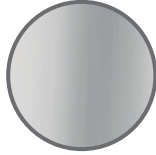

inox

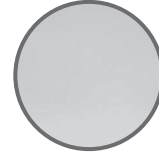

cromo
chrome
chromée



anodizado alto brillo
anodized high gloss
anodisé brillant

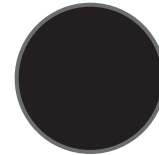

negro mate
matt black
noir mat

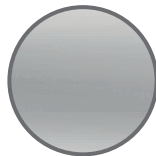

aluminio plata
aluminium silver
aluminium argent

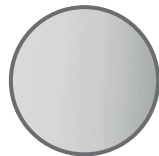

aluminio acabado inox
aluminium inox
aluminium finition inox

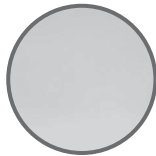

cromados satinados
satin chrome finish
chrome satiné

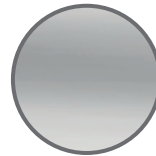

plata
silver
argent



aluminio anodizado satinados
satin anodized aluminium
aluminium anodisé satiné

KRION
PORCELANOSA Grupo

KRION SOLID SURFACE, S.A.U.

Ctra. Vila-real-Puebla de Arenoso (CV20) Km 1 ·
12540 VILA-REAL (CASTELLÓN) SPAIN
PO/BOX. 372 - Tel: (+34) 964 50 64 64
Fax. (+34) 964 50 64 81
krion@krion.com / www.krion.com

Aviso Legal: Las imágenes, textos y datos son propiedad de KRION SOLID SURFACE, S.A.U., con domicilio en Carretera Vila-real – Puebla de Arenoso (CV-20), 12.540 Vila-real (Castellón). Se requiere su consentimiento expreso y por escrito para la utilización y divulgación, ya sea parcial o total, de los referidos contenidos. Corresponde a KRION SOLID SURFACE, S.A.U. el ejercicio exclusivo de los derechos de explotación de los mismos en cualquier forma, y en especial los derechos de reproducción, distribución, comunicación pública y transformación. Todo este material está protegido por la legislación de la propiedad intelectual y su uso indebido puede ser objeto de sanciones, incluso penales.

Legal notice: The images, texts and data are the property of KRION SOLID SURFACE, S.A.U., with registered offices at Carretera Vila-real – Puebla de Arenoso (CV-20), 12.540 Vila-real (Castellón). The express written consent of KRION SOLID SURFACE, S.A.U., shall be required for the partial or total use or disclosure of the said material. KRION SOLID SURFACE, S.A.U., holds sole rights over all forms of use of the said material and, in particular, the right to its reproduction, distribution, public communication and transformation. All the said material is protected by intellectual property laws and any undue use may result in penalties, even of a criminal kind.

Mentions légales : Les images, les textes et les données appartiennent à KRION SOLID SURFACE, S.A.U., dont le domicile est sis à Carretera Vila-real – Puebla de Arenoso (CV-20), 12 540 Vila-real (Castellón). L'utilisation et la divulgation, en tout ou partie, des contenus mentionnés est interdite sauf consentement exprès préalable par écrit de sa part. L'exercice des droits d'exploitation de ceux-ci, d'une quelconque manière, et notamment les droits de reproduction, distribution, communication publique et transformation correspond exclusivement à KRION SOLID SURFACE, S.A.U. Tout ce matériel est protégé par la législation relative à la propriété intellectuelle et un usage indu de celui-ci peut donner lieu à des sanctions, y compris à caractère pénal.

KRION
PORCELANOSA Grupo